

# E S6 A 300X300X160 - Empty enclosure



0899025

<https://www.phoenixcontact.com/us/products/0899025>

Please be informed that the data shown in this PDF document is generated from our online catalog. Please find the complete data in the user documentation. Our general terms of use for downloads are valid.



Empty enclosure, material: Stainless steel, 316L/1.4404, surface resistance: brushed, silver-colored, 300 mm x 300 mm x 160 mm, type of locking: Screw-on cover, scope of supply - ATD: Mounting panel, Fixing angle with mounting screws, M12 grounding bolts, affixed externally, Installation notes, Mounting panel

## Your advantages

- Innovative product range of high-quality stainless steel housings as the basis for individual terminal boxes
- Reduced assembly and approval effort thanks to ready-equipped terminal boxes
- Flange plates possible on four sides of the housing, including seal protection
- Housing adjustments using threads, bore holes, and rectangular cutouts with consideration given to normative specifications

## Commercial data

Item number	0899025
Packing unit	1 pc
Minimum order quantity	1 pc
Note	Made to order (non-returnable)
Sales key	BH91
Product key	BH9112
GTIN	4046356927833
Weight per piece (including packing)	5.62 kg
Weight per piece (excluding packing)	5.62 kg
Customs tariff number	94032080
Country of origin	DE

# E S6 A 300X300X160 - Empty enclosure



0899025

<https://www.phoenixcontact.com/us/products/0899025>

## Technical data

### Product properties

Product type	Terminal box
Scope of supply	Mounting panel
	Fixing angle with mounting screws
	M12 grounding bolts, affixed externally
	Installation notes

### Insulation characteristics

Protection class	I
------------------	---

### Electrical properties

Maximum power dissipation	14 W (T6 up to 40 °C)
	8.7 W (T6 up to 55 °C)
	5.2 W (T6 up to 65 °C)
	19.3 W (T5 up to 40 °C)
	14 W (T5 up to 55 °C)
	10.5 W (T5 up to 65 °C)
	22.8 W (T4 up to 40 °C)
	10.9 W (T4 up to 55 °C)
14 W (T4 up to 65 °C)	

### Dimensions

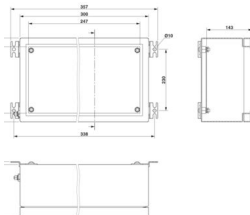
Dimensional drawing	
Width	300 mm
Height	300 mm
Depth	160 mm
Clearance width, maximum DIN rail length	244 mm
Max. material thickness	1.5 mm

### Material specifications

Color	silver-colored
Material	Stainless steel, 316L/1.4404
Seal material	Silicon
Surface characteristics	brushed
Note	240 grain

# E S6 A 300X300X160 - Empty enclosure



0899025

<https://www.phoenixcontact.com/us/products/0899025>

## Mechanical properties

### General

Type of locking (GRP)

Screw-on cover Allen screws

## Environmental and real-life conditions

### Degree of protection (IP code)

Degree of protection

IP66

### Ambient conditions

Ambient temperature (operation)

-55 °C ... 135 °C

## Mounting

Assembly note

External fixing clips

# E S6 A 300X300X160 - Empty enclosure



0899025

<https://www.phoenixcontact.com/us/products/0899025>

## Drawings

Dimensional drawing

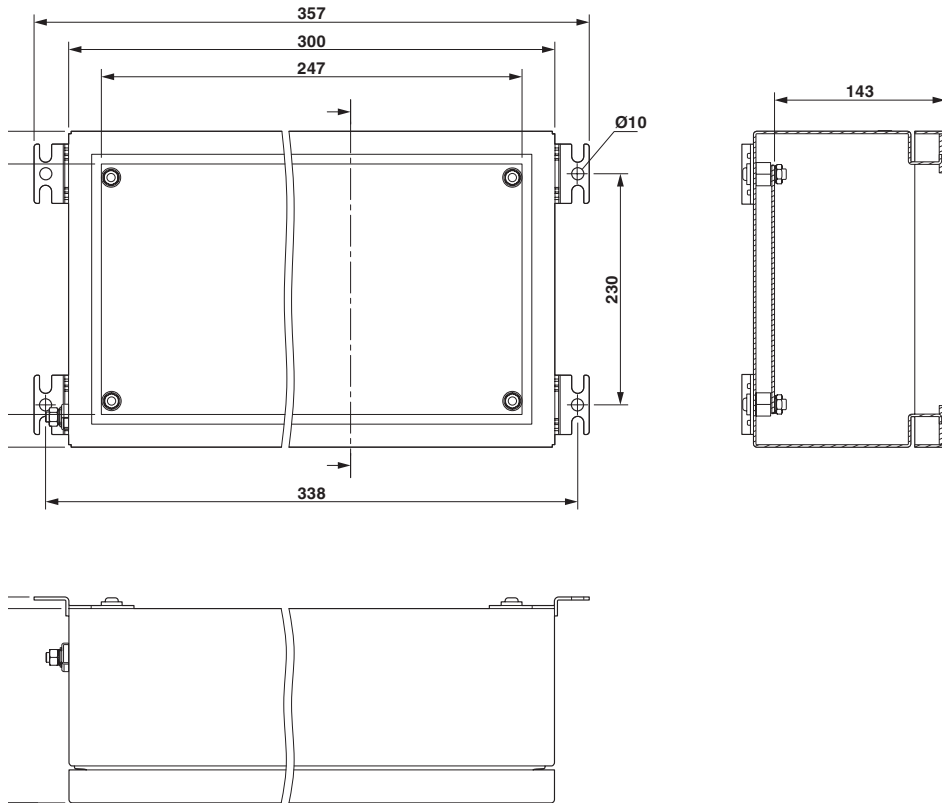

# E S6 A 300X300X160 - Empty enclosure

0899025

<https://www.phoenixcontact.com/us/products/0899025>



Schematic diagram



# E S6 A 300X300X160 - Empty enclosure



0899025

<https://www.phoenixcontact.com/us/products/0899025>

## Classifications

### ECLASS

ECLASS-13.0	27180101
ECLASS-15.0	27180101

### ETIM

ETIM 10.0	EC000261
-----------	----------

### UNSPSC

UNSPSC 21.0	31261500
-------------	----------

# E S6 A 300X300X160 - Empty enclosure



0899025

<https://www.phoenixcontact.com/us/products/0899025>

## Environmental product compliance

### EU RoHS

Fulfills EU RoHS substance requirements	Yes, No exemptions
---	--------------------

### China RoHS

Environment friendly use period (EFUP)	EFUP-E
	No hazardous substances above the limits

### EU REACH SVHC

REACH candidate substance (CAS No.)	No substance above 0.1 wt%
-------------------------------------	----------------------------

Phoenix Contact 2026 © - all rights reserved  
<https://www.phoenixcontact.com>

Phoenix Contact USA  
586 Fulling Mill Road  
Middletown, PA 17057, United States  
(+717) 944-1300  
[info@phoenixcon.com](mailto:info@phoenixcon.com)