

E S6 A 200X200X80 - Empty enclosure



0899007

<https://www.phoenixcontact.com/us/products/0899007>

Please be informed that the data shown in this PDF document is generated from our online catalog. Please find the complete data in the user documentation. Our general terms of use for downloads are valid.



Empty enclosure, material: Stainless steel, 316L/1.4404, surface resistance: brushed, silver-colored, 200 mm x 200 mm x 80 mm, type of locking: Screw-on cover, scope of supply - ATD: Mounting panel, Fixing angle with mounting screws, M12 grounding bolts, affixed externally, Installation notes, Mounting panel

Your advantages

- Innovative product range of high-quality stainless steel housings as the basis for individual terminal boxes
- Reduced assembly and approval effort thanks to ready-equipped terminal boxes
- Flange plates possible on four sides of the housing, including seal protection
- Housing adjustments using threads, bore holes, and rectangular cutouts with consideration given to normative specifications

Commercial data

| | |
|--------------------------------------|--------------------------------|
| Item number | 0899007 |
| Packing unit | 1 pc |
| Minimum order quantity | 1 pc |
| Note | Made to order (non-returnable) |
| Sales key | BH91 |
| Product key | BH9112 |
| GTIN | 4046356927659 |
| Weight per piece (including packing) | 2.373 kg |
| Weight per piece (excluding packing) | 2.373 kg |
| Customs tariff number | 94032080 |
| Country of origin | DE |

E S6 A 200X200X80 - Empty enclosure



0899007

<https://www.phoenixcontact.com/us/products/0899007>

Technical data

Product properties

| | |
|-----------------|---|
| Product type | Terminal box |
| Scope of supply | Mounting panel |
| | Fixing angle with mounting screws |
| | M12 grounding bolts, affixed externally |
| | Installation notes |

Insulation characteristics

| | |
|------------------|---|
| Protection class | I |
|------------------|---|

Electrical properties

| | |
|---------------------------|------------------------|
| Maximum power dissipation | 8 W (T6 up to 40 °C) |
| | 5 W (T6 up to 55 °C) |
| | 3 W (T6 up to 65 °C) |
| | 11 W (T5 up to 40 °C) |
| | 8 W (T5 up to 55 °C) |
| | 6 W (T5 up to 65 °C) |
| | 13 W (T4 up to 40 °C) |
| | 6.3 W (T4 up to 55 °C) |
| 8 W (T4 up to 65 °C) | |

Dimensions

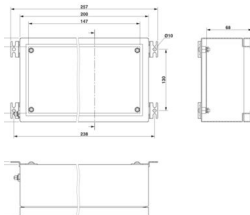
| | |
|--|--|
| Dimensional drawing |  |
| Width | 200 mm |
| Height | 200 mm |
| Depth | 80 mm |
| Clearance width, maximum DIN rail length | 144 mm |
| Max. material thickness | 1.5 mm |

Material specifications

| | |
|-------------------------|------------------------------|
| Color | silver-colored |
| Material | Stainless steel, 316L/1.4404 |
| Seal material | Silicon |
| Surface characteristics | brushed |
| Note | 240 grain |

E S6 A 200X200X80 - Empty enclosure



0899007

<https://www.phoenixcontact.com/us/products/0899007>

Mechanical properties

General

Type of locking (GRP)

Screw-on cover Allen screws

Environmental and real-life conditions

Degree of protection (IP code)

Degree of protection

IP66

Ambient conditions

Ambient temperature (operation)

-55 °C ... 135 °C

Mounting

Assembly note

External fixing clips

E S6 A 200X200X80 - Empty enclosure



0899007

<https://www.phoenixcontact.com/us/products/0899007>

Drawings

Dimensional drawing

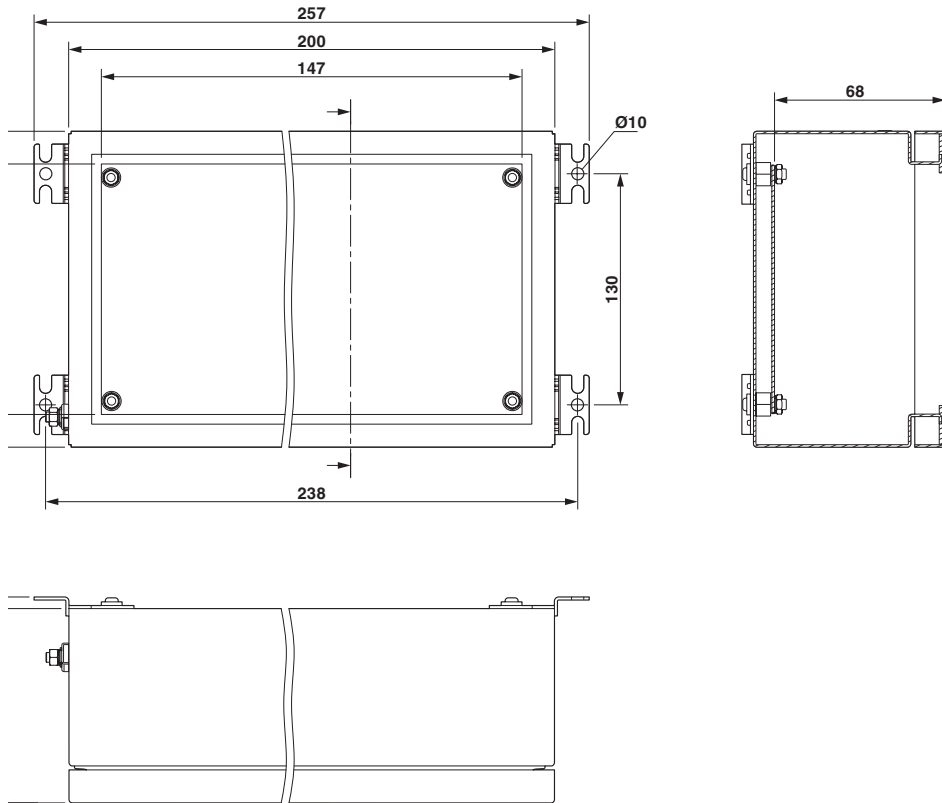

E S6 A 200X200X80 - Empty enclosure

0899007

<https://www.phoenixcontact.com/us/products/0899007>



Schematic diagram



E S6 A 200X200X80 - Empty enclosure



0899007

<https://www.phoenixcontact.com/us/products/0899007>

Classifications

ECLASS

| | |
|-------------|----------|
| ECLASS-13.0 | 27180101 |
| ECLASS-15.0 | 27180101 |

ETIM

| | |
|-----------|----------|
| ETIM 10.0 | EC000261 |
|-----------|----------|

UNSPSC

| | |
|-------------|----------|
| UNSPSC 21.0 | 31261500 |
|-------------|----------|

E S6 A 200X200X80 - Empty enclosure



0899007

<https://www.phoenixcontact.com/us/products/0899007>

Environmental product compliance

EU RoHS

| | |
|---|--------------------|
| Fulfills EU RoHS substance requirements | Yes, No exemptions |
|---|--------------------|

China RoHS

| | |
|--|--|
| Environment friendly use period (EFUP) | EFUP-E |
| | No hazardous substances above the limits |

EU REACH SVHC

| | |
|-------------------------------------|----------------------------|
| REACH candidate substance (CAS No.) | No substance above 0.1 wt% |
|-------------------------------------|----------------------------|

Phoenix Contact 2026 © - all rights reserved
<https://www.phoenixcontact.com>

Phoenix Contact USA
586 Fulling Mill Road
Middletown, PA 17057, United States
(+717) 944-1300
info@phoenixcon.com