

GPE 27X 8 SR/R - Engraving material



0806877

<https://www.phoenixcontact.com/us/products/0806877>

Please be informed that the data shown in this PDF document is generated from our online catalog. Please find the complete data in the user documentation. Our general terms of use for downloads are valid.

Engraving material, Sheet, unmarked, can be labeled with: PLOTMARK, ENGRAVING UNIT, CMS-P1-PLOTTER, P1 ENGRAVING UNIT, mounting type: adhesive, Number of individual labels: 66, text field height: 8 mm, text field width: 27 mm



Your advantages

- Labeling service: Phoenix Contact can custom-label all GPE ... markers according to your requirements
- The adhesive foil used ensures good adhesive properties, even on uneven surfaces
- Two-layer material
- The label sheet consists of prefabricated, individual self-adhesive labels
- Can be engraved using the P1 ENGRAVING UNIT
- Can be labeled easily using the CMS-P1-PLOTTER

Commercial data

Item number	0806877
Packing unit	10 pc
Minimum order quantity	10 pc
Sales key	BG19
Product key	BG2415
GTIN	4017918145002
Weight per piece (including packing)	18.43 g
Weight per piece (excluding packing)	18.43 g
Customs tariff number	39203000
Country of origin	DE

GPE 27X 8 SR/R - Engraving material



0806877

<https://www.phoenixcontact.com/us/products/0806877>

Technical data

Product properties

Product type	Device marker
--------------	---------------

Marking

Number of individual labels	66
Number of individual labels per row	3

Dimensions

Width	27.00 mm
Height	8.00 mm
Depth	0.85 mm

Text field

Text field width	27 mm
Text field height	8 mm

Material specifications

Adhesive strength	50 µm
Adhesive	Acrylic
Color	silver-colored
Material	TRANSPLY-ABS
Base element material	TRANSPLY-ABS
Components	free from silicone and halogen

Environmental and real-life conditions

Ambient conditions

Ambient temperature (operation)	-20 °C ... 85 °C
Recommended ambient temperature (storage/transport)	20 °C
Recommended humidity (storage/transport)	50 %

UV resistance

Specification	DIN EN ISO 4892-2:2021-11 (following)
Result	Test passed
Procedure	Artificial irradiation.

Wipe resistance of inscriptions

Specification	DIN EN 61010-1 (VDE 0411-1):2011-07
Isopropanol (99%) [67-63-0]	Test passed
n-Hexane [CAS No. 110-54-3]	Test passed
Water + Petroleum ether [CAS No. 64742-82-1]	Test passed

Standards and regulations

GPE 27X 8 SR/R - Engraving material



0806877

<https://www.phoenixcontact.com/us/products/0806877>

Wipe resistance	DIN EN 61010-1 (VDE 0411-1)
-----------------	-----------------------------

Mounting

Mounting type	adhesive
---------------	----------

GPE 27X 8 SR/R - Engraving material

0806877

<https://www.phoenixcontact.com/us/products/0806877>



Drawings

Dimensional drawing

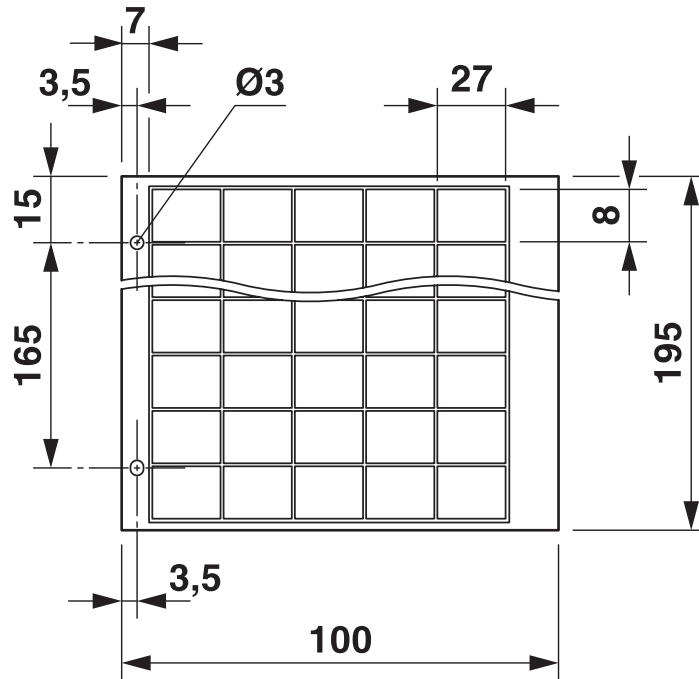

GPE 27X 8 SR/R - Engraving material



0806877

<https://www.phoenixcontact.com/us/products/0806877>

Classifications

ECLASS

ECLASS-13.0	27281103
ECLASS-15.0	27281103

ETIM

ETIM 10.0	EC001288
-----------	----------

UNSPSC

UNSPSC 21.0	39131500
-------------	----------

GPE 27X 8 SR/R - Engraving material



0806877

<https://www.phoenixcontact.com/us/products/0806877>

Environmental product compliance

EU RoHS

Fulfills EU RoHS substance requirements	Yes, No exemptions
---	--------------------

EU REACH SVHC

REACH candidate substance (CAS No.)	No substance above 0.1 wt%
-------------------------------------	----------------------------

Phoenix Contact 2026 © - all rights reserved

<https://www.phoenixcontact.com>

Phoenix Contact USA
586 Fulling Mill Road
Middletown, PA 17057, United States
(+717) 944-1300
info@phoenixcon.com