

# AKG 16 GNYE - Connection terminal block



0423027

<https://www.phoenixcontact.com/us/products/0423027>

Please be informed that the data shown in this PDF document is generated from our online catalog. Please find the complete data in the user documentation. Our general terms of use for downloads are valid.



Connection terminal block, nom. voltage: 300 V, nominal current: 76 A, connection method: Screw connection, Rated cross section: 16 mm<sup>2</sup>, cross section: 1.5 mm<sup>2</sup> - 16 mm<sup>2</sup>, mounting: Neutral busbar, color: green-yellow

## Commercial data

Item number	0423027
Packing unit	50 pc
Minimum order quantity	50 pc
Sales key	BE73
Product key	BE7331
GTIN	4017918002008
Weight per piece (including packing)	10.58 g
Weight per piece (excluding packing)	10.55 g
Customs tariff number	85369010
Country of origin	IN

# AKG 16 GNYE - Connection terminal block



0423027

<https://www.phoenixcontact.com/us/products/0423027>

## Technical data

### Product properties

Product type	Installation terminal block
Number of connections	1
Number of rows	1

### Electrical properties

Maximum load current	76 A (with 16 mm <sup>2</sup> conductor cross-section)
Maximum power dissipation for nominal condition	2.43 W
Nominal current I <sub>N</sub>	76 A
Current carrying capacity of the neutral busbar	140 A

### Connection data

Nominal cross section	16 mm <sup>2</sup>
Maximum load current	76 A (with 16 mm <sup>2</sup> conductor cross-section)

#### Level 1 above 1 below 1

Connection method	Screw connection
Screw thread	M5
Tightening torque	2.5 ... 3 Nm
Stripping length	16 mm
Conductor cross-section rigid	1.5 mm <sup>2</sup> ... 16 mm <sup>2</sup>
Cross section AWG	14 ... 6 (converted acc. to IEC)
Conductor cross-section flexible	1.5 mm <sup>2</sup> ... 16 mm <sup>2</sup>
Conductor cross-section, flexible [AWG]	14 ... 6 (converted acc. to IEC)
Conductor cross-section flexible (ferrule without plastic sleeve)	1.5 mm <sup>2</sup> ... 16 mm <sup>2</sup>
Flexible conductor cross-section (ferrule with plastic sleeve)	1.5 mm <sup>2</sup> ... 16 mm <sup>2</sup>
2 conductors with same cross section, rigid	1.5 mm <sup>2</sup> ... 6 mm <sup>2</sup>
2 conductors with same cross section, flexible	1.5 mm <sup>2</sup> ... 6 mm <sup>2</sup>
2 conductors with same cross section, flexible, with ferrule without plastic sleeve	1.5 mm <sup>2</sup> ... 6 mm <sup>2</sup>
2 conductors with the same cross section, flexible, with TWIN ferrule with plastic sleeve	1.5 mm <sup>2</sup> ... 10 mm <sup>2</sup>
Nominal cross section	16 mm <sup>2</sup>
Nominal current	76 A
Maximum load current	76 A (with 16 mm <sup>2</sup> conductor cross-section)
Nominal voltage	300 V

### Dimensions

# AKG 16 GNYE - Connection terminal block

0423027

<https://www.phoenixcontact.com/us/products/0423027>

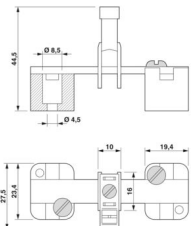
Dimensional drawing	
Width	9.8 mm
Height	23.4 mm
Depth	32 mm
Length	23.4 mm

## Material specifications

Color	green-yellow
Flammability rating according to UL 94	V2
Insulating material	PA
Static insulating material application in cold	-40 °C
Temperature index of insulation material (DIN EN 60216-1 (VDE 0304-21))	125 °C
Relative insulation material temperature index (Elec., UL 746 B)	125 °C

## Environmental and real-life conditions

### Ambient conditions

Ambient temperature (operation)	-60 °C ... 110 °C (Operating temperature range incl. self-heating; for max. short-term operating temperature, see RTI Elec.)
Ambient temperature (storage/transport)	-25 °C ... 60 °C (for a short time, not exceeding 24 h, -60 °C to +70 °C)
Ambient temperature (assembly)	-5 °C ... 70 °C
Ambient temperature (actuation)	-5 °C ... 70 °C
Permissible humidity (operation)	20 % ... 90 %
Permissible humidity (storage/transport)	30 % ... 70 %

## Mounting

Mounting type	Neutral busbar
---------------	----------------

# AKG 16 GNYE - Connection terminal block

0423027

<https://www.phoenixcontact.com/us/products/0423027>

## Drawings

Dimensional drawing

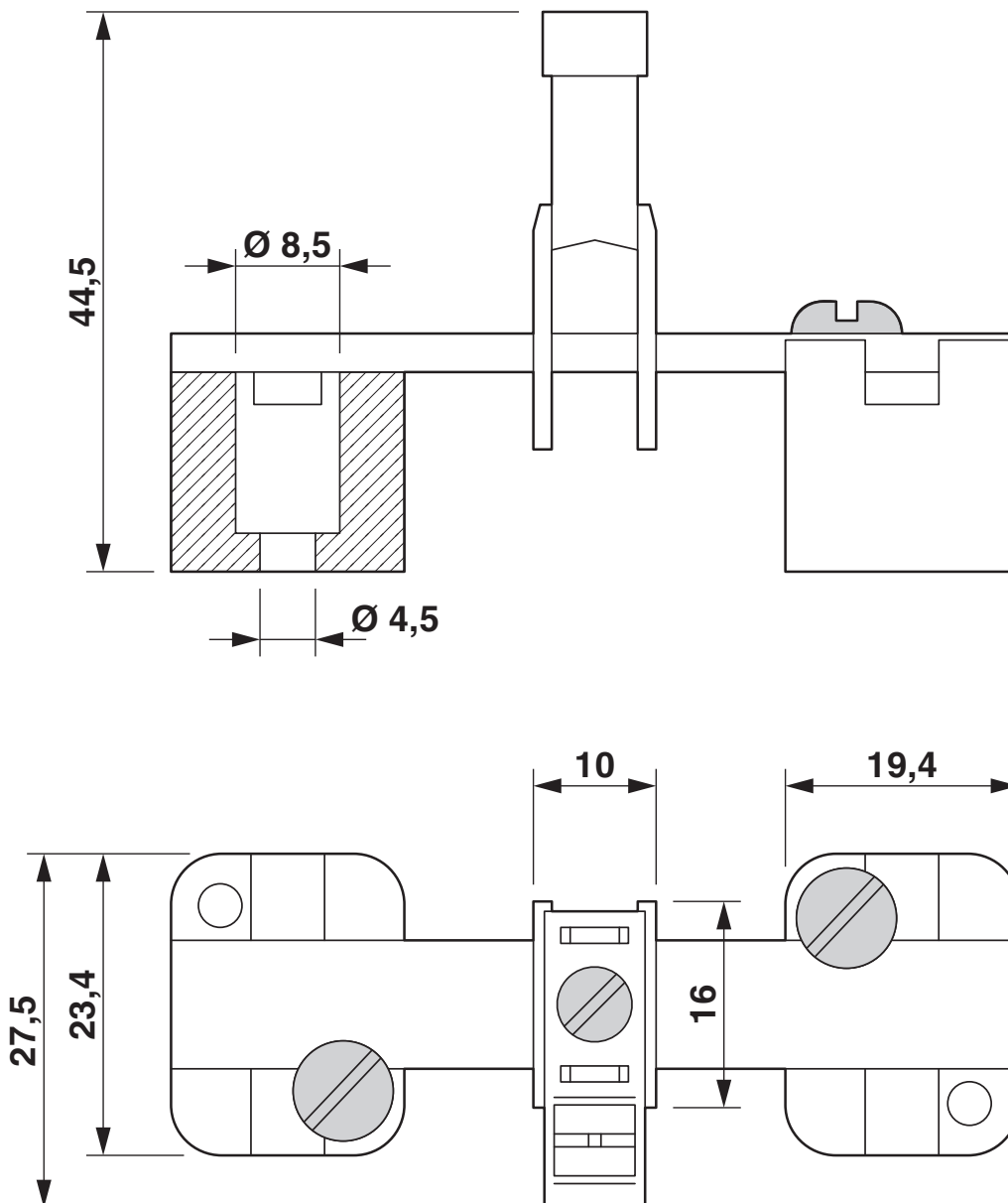

# AKG 16 GNYE - Connection terminal block



0423027

<https://www.phoenixcontact.com/us/products/0423027>

Dimensional drawing

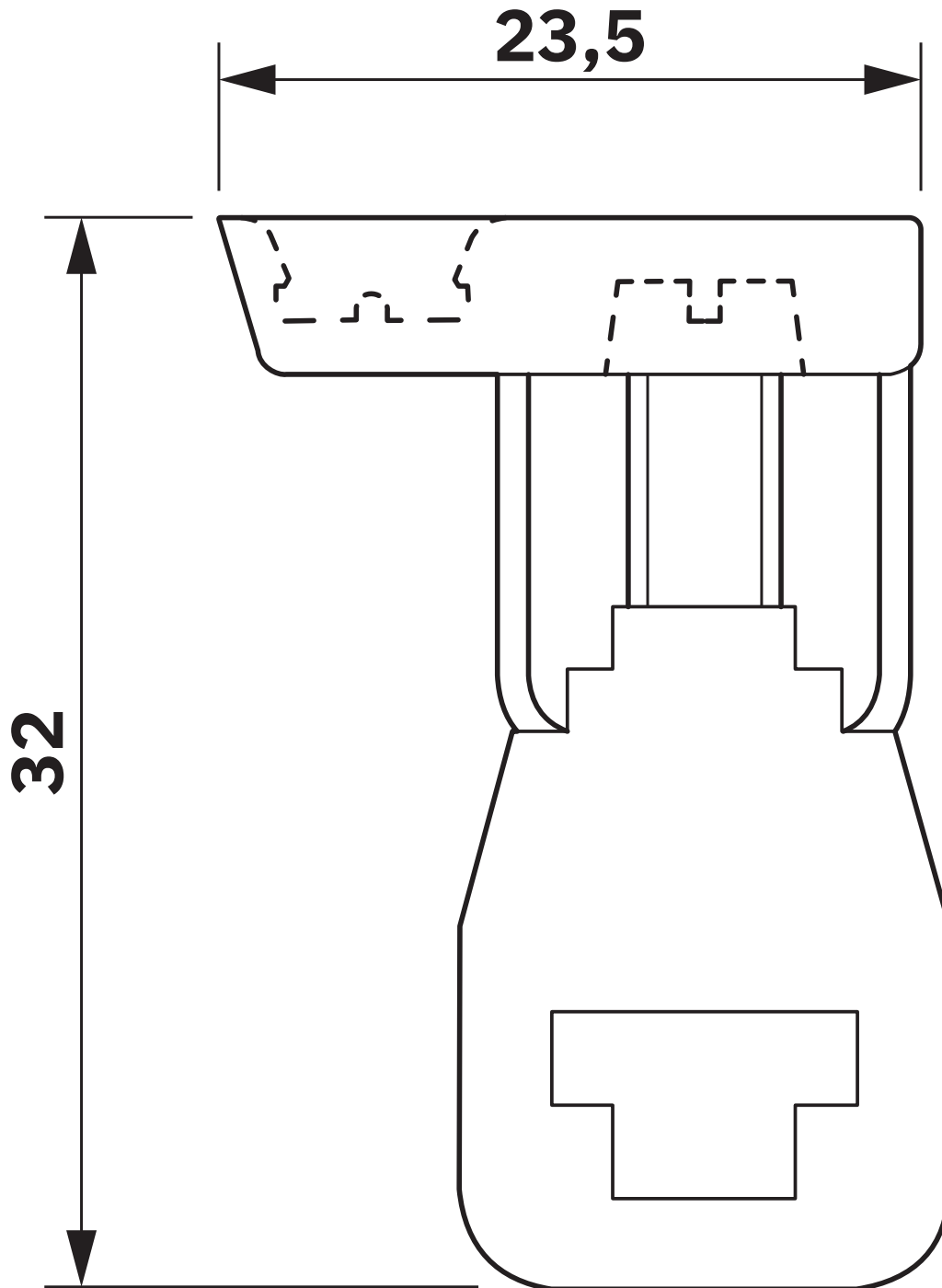

# AKG 16 GNYE - Connection terminal block





0423027

<https://www.phoenixcontact.com/us/products/0423027>

## Approvals

To download certificates, visit the product detail page: <https://www.phoenixcontact.com/us/products/0423027>

 <b>CSA</b> Approval ID: 13631				
	Nominal voltage $U_N$	Nominal current $I_N$	Cross section AWG	Cross section $\text{mm}^2$
keine				
	-	65 A	18 - 6	-

 <b>UL Recognized</b> Approval ID: E60425				
	Nominal voltage $U_N$	Nominal current $I_N$	Cross section AWG	Cross section $\text{mm}^2$
B				
	-	-	18 - 6	-
C				
	-	-	18 - 6	-
F				
	-	-	18 - 6	-

 <b>EAC</b> Approval ID: KZ7500651131219505				
---	--	--	--	--

# AKG 16 GNYE - Connection terminal block



0423027

<https://www.phoenixcontact.com/us/products/0423027>

## Classifications

### ECLASS

ECLASS-13.0	27250116
ECLASS-15.0	27250116

### ETIM

ETIM 10.0	EC000001
-----------	----------

### UNSPSC

UNSPSC 21.0	31162900
-------------	----------

# AKG 16 GNYE - Connection terminal block



0423027

<https://www.phoenixcontact.com/us/products/0423027>

## Environmental product compliance

### EU RoHS

Fulfills EU RoHS substance requirements	Yes, No exemptions
---	--------------------

### China RoHS

Environment friendly use period (EFUP)	EFUP-E
	No hazardous substances above the limits

### EU REACH SVHC

REACH candidate substance (CAS No.)	No substance above 0.1 wt%
-------------------------------------	----------------------------

Phoenix Contact 2026 © - all rights reserved  
<https://www.phoenixcontact.com>

Phoenix Contact USA  
586 Fulling Mill Road  
Middletown, PA 17057, United States  
(+717) 944-1300  
[info@phoenixcon.com](mailto:info@phoenixcon.com)