

Connector set - HC-EVO-B24PT-BWD-HH-M32-PLRBK - 1407713

Please be informed that the data shown in this PDF Document is generated from our Online Catalog. Please find the complete data in the user's documentation. Our General Terms of Use for Downloads are valid (<http://phoenixcontact.com/download>)

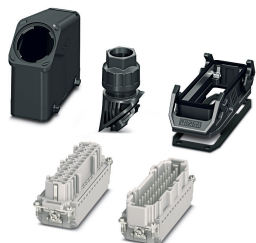

EVO connector set, consisting of sleeve housing, panel mounting base, push-in contact inserts: 1407735, 1407736, 1407661, 1407657, 1407671

Your advantages

- ✓ Lower costs than metal version
- ✓ Labeling option using 9 x 20 mm marking label
- ✓ Low weight
- ✓ Lower risk of condensation
- ✓ Both contact insert PE sheets are connected by means of a metal frame integrated in the sleeve housing
- ✓ Metal inlays ensure leading PE contact with angled plugs
- ✓ Completely corrosion-resistant
- ✓ Halogen-free plastic
- ✓ Marking label can be attached



Key Commercial Data

Packing unit	1 pc
GTIN	 4 046356 777780
GTIN	404635677780

Technical data

General

Number of positions	24+PE
Type	B24
Connection method	Push-in connection
Cable outlet	straight
	lateral
Degree of protection for housing	IP66
	12 (UL 50e)

Connector set - HC-EVO-B24PT-BWD-HH-M32-PLRBK - 1407713

Technical data

General

Connection method	Push-in connection
Rated voltage (III/3)	500 V
Rated surge voltage	6 kV
Rated current	16 A
Conductor cross section	0.14 mm ² ... 2.5 mm ² (with ferrule)
Connection cross section AWG	26 ... 14 (with ferrule)
External cable diameter	11 mm ... 21 mm
Ambient temperature (operation)	-40 °C ... 100 °C
Length of the assembly cutout	113 mm
Width of the assembly cutout	35 mm
Housing material	PA
Contact carrier material	PA
Locking latch material	PA
Integrated protective cover	no

Standards and Regulations

Flammability rating according to UL 94	V0
--	----

Environmental Product Compliance

China RoHS	Environmentally friendly use period: unlimited = EFUP-e
	No hazardous substances above threshold values

Drawings

Schematic diagram

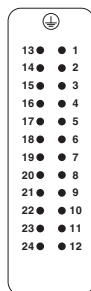

Pin assignment, connection side, pin

Schematic diagram

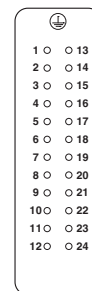

Pin assignment, connection side, socket

Connector set - HC-EVO-B24PT-BWD-HH-M32-PLRBK - 1407713

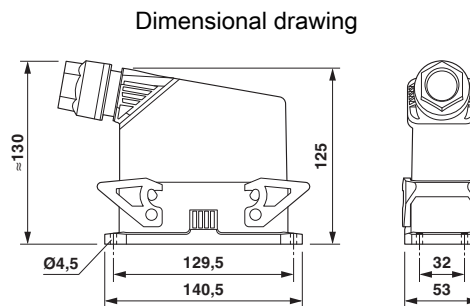
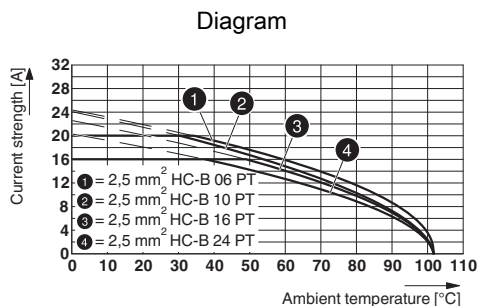

Derating diagram

Dimensional drawing

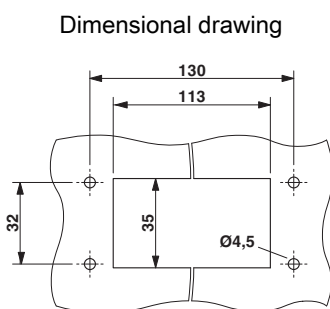

Mounting cutout

Articles in set

Contact insert - HC-B24-I-PT-F - 1407735



Contact insert, number of positions: 24+PE, size: B24, number of connections per position: 1, Socket, Push-in connection, 500 V, 16 A, 0.14 mm² ... 2.5 mm², application: Power

Contact insert - HC-B24-I-PT-M - 1407736



HEAVYCON pin insert, B24 series, 24 + PE-pos., push-in connection

Housing - HC-EVO-B24-BWD-PLRBK - 1407661



HEAVYCON EVO panel mounting base, plastic, B24, with double locking latch, height: 30.5 mm, with flat gasket

Connector set - HC-EVO-B24PT-BWD-HH-M32-PLRBK - 1407713

Articles in set

Housing - HC-EVO-B24-HHFD-PLBK - 1407657



HEAVYCON EVO sleeve housing, plastic, with bayonet flange for EVO screw connection, B24, for double locking latch, height: 87.5 mm, without EVO screw connection

Cable gland - HC-B-G-M32-PLRBK - 1407671



EVO plastic cable gland with bayonet locking, for housing series B, size M32, cable diameter: 11 ... 21 mm

Classifications

eCl@ss

eCl@ss 10.0.1	27440101
eCl@ss 11.0	27440101
eCl@ss 4.0	27260700
eCl@ss 4.1	27260700
eCl@ss 5.0	27260700
eCl@ss 5.1	27260700
eCl@ss 6.0	27260700
eCl@ss 7.0	27440101
eCl@ss 9.0	27440101

ETIM

ETIM 3.0	EC000438
ETIM 4.0	EC000437
ETIM 5.0	EC000437
ETIM 6.0	EC002636
ETIM 7.0	EC002636

UNSPSC

UNSPSC 6.01	30211923
UNSPSC 7.0901	39121522
UNSPSC 11	39121522
UNSPSC 12.01	39121522
UNSPSC 13.2	39121409

Connector set - HC-EVO-B24PT-BWD-HH-M32-PLRBK - 1407713

Classifications

UNSPSC

UNSPSC 18.0	39121409
UNSPSC 19.0	39121409
UNSPSC 20.0	39121409
UNSPSC 21.0	39121409

Approvals

Approvals

Approvals

EAC / DNV GL

Ex Approvals

Approval details

EAC		RU C- DE.BL08.B.00511
-----	--	--------------------------

DNV GL		https://approvalfinder.dnvgl.com/	TAE000037S
--------	--	---	------------

Accessories

Accessories

Device marking

Snap-in markers - US-EMP (20X9) - 0829439



Snap-in markers, Card, white, unlabeled, can be labeled with: BLUEMARK ID COLOR, BLUEMARK ID, THERMOMARK PRIME, THERMOMARK CARD 2.0, THERMOMARK CARD, mounting type: snapped into marker carrier, lettering field size: 20 x 9 mm, Number of individual labels: 70

Housing latches

Connector set - HC-EVO-B24PT-BWD-HH-M32-PLRBK - 1407713

Accessories

Double locking latch - HC-B10-24-DL-PLBK - 1407696



Replacement double locking latch for HEAVYCON EVO housing, HC-B10/HC-B16/HC-B24, PA

Phoenix Contact 2021 © - all rights reserved
<http://www.phoenixcontact.com>

PHOENIX CONTACT GmbH & Co. KG
Flachsmarktstr. 8
32825 Blomberg
Germany
Tel. +49 5235 300
Fax +49 5235 3 41200
<http://www.phoenixcontact.com>