

# BCH-350VF-13 GN - PCB header



5444181

<https://www.phoenixcontact.com/us/products/5444181>

Please be informed that the data shown in this PDF document is generated from our online catalog. Please find the complete data in the user documentation. Our general terms of use for downloads are valid.

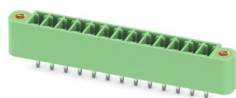
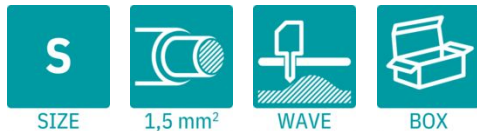

PCB headers, nominal cross section: 1.5 mm<sup>2</sup>, color: pastel green, nominal current: 8 A, rated voltage (III/2): 160 V, contact surface: Sn, contact connection type: Pin, number of potentials: 13, number of rows: 1, number of positions: 13, number of connections: 13, product range: BCH-VF, pitch: 3.5 mm, mounting: Wave soldering, pin layout: Linear pinning, solder pin [P]: 3.4 mm, number of solder pins per potential: 1, plug-in system: BASICLINE 1,5, Pin connector pattern alignment: Standard, locking: Screw locking mechanism, mounting method: Threaded flange, type of packaging: packed in cardboard

## Your advantages

- Well-known mounting principle allows worldwide use

## Commercial data

Item number	5444181
Packing unit	100 pc
Minimum order quantity	100 pc
Note	Made to order (non-returnable)
Sales key	AA02
Product key	AABSXD
GTIN	4046356835992
Weight per piece (including packing)	4.042 g
Weight per piece (excluding packing)	4.042 g
Customs tariff number	85366930
Country of origin	CN

## Technical data

### Product properties

Product type	PCB headers
Product family	BCH-VF
Product line	COMBICON Connectors S
Type	Standard
Number of positions	13
Pitch	3.5 mm
Number of connections	13
Number of rows	1
Number of potentials	13
Mounting type	Threaded flange
Pin layout	Linear pinning
Solder pins per potential	1

### Electrical properties

#### Properties

Nominal current $I_N$	8 A
Nominal voltage $U_N$	160 V
Contact resistance	4.2 mΩ
Rated voltage (III/3)	160 V
Rated surge voltage (III/3)	2.5 kV
Rated voltage (III/2)	160 V
Rated surge voltage (III/2)	2.5 kV
Rated voltage (II/2)	320 V
Rated surge voltage (II/2)	2.5 kV

### Mounting

Mounting type	Wave soldering
Pin layout	Linear pinning

#### Flange

Tightening torque	0.3 Nm
-------------------	--------

### Material specifications

#### Material data - contact

Note	WEEE/RoHS-compliant, free of whiskers according to IEC 60068-2-82/JEDEC JESD 201
Contact material	Cu alloy
Surface characteristics	Tin-plated
Metal surface contact area (top layer)	Tin (4 μm - 8 μm Sn)
Metal surface contact area (middle layer)	Nickel (1.5 μm - 4 μm Ni)

# BCH-350VF-13 GN - PCB header

5444181

<https://www.phoenixcontact.com/us/products/5444181>

Metal surface soldering area (top layer)	Tin (4 µm - 8 µm Sn)
Metal surface soldering area (middle layer)	Nickel (1.5 µm - 4 µm Ni)

## Material data - housing

Color (Housing)	pastel green (6019)
Insulating material	PA
Insulating material group	I
CTI according to IEC 60112	600
Flammability rating according to UL 94	V0
Glow wire flammability index GWFI according to EN 60695-2-12	850
Glow wire ignition temperature GWIT according to EN 60695-2-13	775
Temperature for the ball pressure test according to EN 60695-10-2	125 °C

## Dimensions

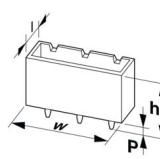
Dimensional drawing	
Pitch	3.5 mm
Width [w]	55.8 mm
Height [h]	12.6 mm
Length [l]	7.4 mm
Installed height	9.2 mm
Solder pin length [P]	3.4 mm
Pin dimensions	0.8 x 0.8 mm

## PCB design

Hole diameter	1.2 mm
---------------	--------

## Mechanical tests

### Visual inspection

Specification	IEC 60512-1-1:2002-02
Result	Test passed

### Dimension check

Specification	IEC 60512-1-2:2002-02
Result	Test passed

### Resistance of inscriptions

Specification	IEC 60068-2-70:1995-12
Result	Test passed

### Polarization and coding

# BCH-350VF-13 GN - PCB header



5444181

<https://www.phoenixcontact.com/us/products/5444181>

Specification	IEC 60512-13-5:2006-02
Result	Test passed

## Insertion and withdrawal forces

Specification	IEC 60512-13-2:2006-02
Result	Test passed
No. of cycles	25
Insertion strength per pos. approx.	5 N
Withdraw strength per pos. approx.	2 N

## Electrical tests

### Thermal test | Test group C

Specification	IEC 60512-5-1:2002-02
Tested number of positions	16

### Insulation resistance

Specification	IEC 60512-3-1:2002-02
Insulation resistance, neighboring positions	> 5 M $\Omega$

### Air clearances and creepage distances |

Specification	IEC 60664-1:2007-04
Insulating material group	I
Comparative tracking index (IEC 60112)	CTI 600
Rated insulation voltage (III/3)	160 V
Rated surge voltage (III/3)	2.5 kV
minimum clearance value - non-homogenous field (III/3)	1.5 mm
minimum creepage distance (III/3)	2 mm
Rated insulation voltage (III/2)	160 V
Rated surge voltage (III/2)	2.5 kV
minimum clearance value - non-homogenous field (III/2)	1.5 mm
minimum creepage distance (III/2)	1.5 mm
Rated insulation voltage (II/2)	320 V
Rated surge voltage (II/2)	2.5 kV
minimum clearance value - non-homogenous field (II/2)	1.5 mm
minimum creepage distance (II/2)	1.6 mm

## Environmental and real-life conditions

### Durability test

Specification	IEC 60512-9-1:2010-03
Impulse withstand voltage at sea level	2.95 kV
Contact resistance R <sub>1</sub>	4.2 m $\Omega$
Contact resistance R <sub>2</sub>	4.2 m $\Omega$
Insertion/withdrawal cycles	25
Insulation resistance, neighboring positions	> 5 M $\Omega$

# BCH-350VF-13 GN - PCB header



5444181

<https://www.phoenixcontact.com/us/products/5444181>

## Climatic test

Specification	EN ISO 22479:2022-06
Corrosive stress	0.2 dm <sup>3</sup> SO <sub>2</sub> on 300 dm <sup>3</sup> /40 °C/1 cycle
Thermal stress	100 °C/168 h
Power-frequency withstand voltage	1.39 kV

## Vibration test

Specification	IEC 60068-2-6:2007-12
Frequency	10 - 150 - 10 Hz
Sweep speed	1 octave/min
Amplitude	0.35 mm (10 Hz ... 60.1 Hz)
Acceleration	5g (60.1 Hz ... 150 Hz)
Test duration per axis	2.5 h
Test directions	X-, Y- and Z-axis

## Ambient conditions

Ambient temperature (storage/transport)	-40 °C ... 70 °C
Relative humidity (storage/transport)	30 % ... 70 %
Ambient temperature (assembly)	-5 °C ... 100 °C
Ambient temperature (operation)	-40 °C ... 100 °C (dependent on the derating curve)

## Packaging specifications

Type of packaging	packed in cardboard
-------------------	---------------------

## Drawings

Dimensional drawing



Diagram



Type: BCVP-350RF-... with BCH-350VF-...



Type: BCP-350VF-... with BCH-350VF-...



Type: BCP-350VF-... with BCH-350VF-...

# BCH-350VF-13 GN - PCB header



5444181

<https://www.phoenixcontact.com/us/products/5444181>

Drilling plan/solder pad geometry



# BCH-350VF-13 GN - PCB header



5444181

<https://www.phoenixcontact.com/us/products/5444181>

## Approvals

To download certificates, visit the product detail page: <https://www.phoenixcontact.com/us/products/5444181>

 <b>cULus Recognized</b> Approval ID: E60425-20071007				
	Nominal voltage $U_N$	Nominal current $I_N$	Cross section AWG	Cross section $\text{mm}^2$
B	250 V	8 A	-	-
D	300 V	8 A	-	-

 <b>VDE report with production monitoring</b> Approval ID: 40040694				
	Nominal voltage $U_N$	Nominal current $I_N$	Cross section AWG	Cross section $\text{mm}^2$
keine	160 V	8 A	-	0.2 - 1.5

# BCH-350VF-13 GN - PCB header



5444181

<https://www.phoenixcontact.com/us/products/5444181>

## Classifications

### ECLASS

ECLASS-13.0	27460201
ECLASS-15.0	27460201

### ETIM

ETIM 10.0	EC002637
-----------	----------

### UNSPSC

UNSPSC 21.0	39121400
-------------	----------

# BCH-350VF-13 GN - PCB header



5444181

<https://www.phoenixcontact.com/us/products/5444181>

## Environmental product compliance

### EU RoHS

Fulfills EU RoHS substance requirements	Yes, No exemptions
---	--------------------

### China RoHS

Environment friendly use period (EFUP)	EFUP-E
	No hazardous substances above the limits

### EU REACH SVHC

REACH candidate substance (CAS No.)	No substance above 0.1 wt%
-------------------------------------	----------------------------

Phoenix Contact 2026 © - all rights reserved  
<https://www.phoenixcontact.com>

Phoenix Contact USA  
586 Fulling Mill Road  
Middletown, PA 17057, United States  
(+717) 944-1300  
[info@phoenixcon.com](mailto:info@phoenixcon.com)