

PTPOWER 35-3L/FE-F - High-current terminal block



3212075

<https://www.phoenixcontact.com/us/products/3212075>

Please be informed that the data shown in this PDF document is generated from our online catalog. Please find the complete data in the user documentation. Our general terms of use for downloads are valid.



High-current terminal block, Blocked, nom. voltage: 1000 V, nominal current: 125 A, number of connections: 8, number of positions: 4, connection method: PowerTurn connection, Rated cross section: 35 mm², cross section: 2.5 mm² - 35 mm², mounting type: direct screw connection, color: gray/black-yellow

Your advantages

- Quick and easy connection is now also possible for large conductors with the high-current terminal block
- In addition to the testing option in the double function shaft, all terminal blocks provide an additional test pick-off
- The compact design and front connection enable wiring in a confined space
- The Push-in connection terminal blocks are characterized by the system features of the CLIPLINE complete system and by easy and tool-free wiring of conductors with ferrules or solid conductors

Commercial data

Item number	3212075
Packing unit	2 pc
Minimum order quantity	2 pc
Sales key	BE22
Product key	BE2211
GTIN	4046356869805
Weight per piece (including packing)	382 g
Weight per piece (excluding packing)	358.4 g
Customs tariff number	85369010
Country of origin	TR

PTPOWER 35-3L/FE-F - High-current terminal block



3212075

<https://www.phoenixcontact.com/us/products/3212075>

Technical data

Product properties

Product type	High current terminal block
Number of positions	4
Pitch	16 mm
Number of connections	8
Number of rows	1
Potentials	4

Insulation characteristics

Overvoltage category	III
Degree of pollution	3

Electrical properties

Rated surge voltage	8 kV
Maximum power dissipation for nominal condition	4.06 W

Connection data

Number of connections per level	8
Nominal cross section	35 mm ²
Rated cross section AWG	2
Connection method	PowerTurn connection
Stripping length	25 mm
Conductor cross-section rigid	2.5 mm ² ... 35 mm ²
Cross section AWG	12 ... 2 (converted acc. to IEC)
Conductor cross-section flexible	2.5 mm ² ... 35 mm ²
Conductor cross-section, flexible [AWG]	12 ... 2 (converted acc. to IEC)
Conductor cross-section flexible (ferrule without plastic sleeve)	2.5 mm ² ... 35 mm ²
Flexible conductor cross-section (ferrule with plastic sleeve)	2.5 mm ² ... 35 mm ²
Nominal cross section	35 mm ²
Nominal current	125 A
Maximum load current	125 A (with 35 mm ² conductor cross-section)
Nominal voltage	1000 V

Connection cross sections directly pluggable

Conductor cross-section rigid	2.5 mm ² ... 35 mm ²
Conductor cross-section, rigid [AWG]	12 ... 2 (converted acc. to IEC)
Conductor cross-section flexible (ferrule without plastic sleeve)	2.5 mm ² ... 35 mm ²
Flexible conductor cross-section (ferrule with plastic sleeve)	2.5 mm ² ... 35 mm ²

Ex data

Rated data (ATEX/IECEx)

Identification	Ⓔ II 2 GD Ex eb IIC Gb
----------------	------------------------

PPOWER 35-3L/FE-F - High-current terminal block



3212075

<https://www.phoenixcontact.com/us/products/3212075>

Operating temperature range	-60 °C ... 110 °C
Ex-certified accessories	1206612 SZF 3-1,0X5,5
	1201662 E/AL-NS 35
List of bridges	Plug-in bridge / FBS 2-16 / 3005963
Bridge data	89 A (25 mm ²)
Ex temperature increase	40 K (120 A/35 mm ²)
for bridging with bridge	690 V
Rated insulation voltage	660 V
output	(Permanent)

Ex level General

Rated voltage	690 V
Rated current	109 A
Maximum load current	109 A
Contact resistance	0.16 mΩ

Ex connection data General

Ferrule length	25 mm
Stripping length	25 mm
Nominal cross section	35 mm ²
Rated cross section AWG	2
Connection capacity rigid	2.5 mm ² ... 35 mm ²
Connection capacity AWG	12 ... 2
Conductor cross-section flexible, with ferrule without plastic sleeve min.	6 mm ²
Conductor cross-section flexible, with ferrule without plastic sleeve max.	35 mm ²

Dimensions

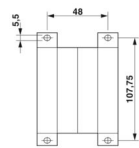
Dimensional drawing	
Width	64 mm
Height	120.2 mm
Depth	68.3 mm
Drill hole spacing	108 mm
Hole diameter	5.5 mm
Pitch	16 mm

Material specifications

Color	multicolored (RAL -)
	gray (RAL 7042)
	black (RAL 9005)

PTPOWER 35-3L/FE-F - High-current terminal block



3212075

<https://www.phoenixcontact.com/us/products/3212075>

	yellow (RAL 1018)
Flammability rating according to UL 94	V0
Insulating material group	I
Insulating material	PA
Static insulating material application in cold	-60 °C
Temperature index of insulation material (DIN EN 60216-1 (VDE 0304-21))	125 °C
Relative insulation material temperature index (Elec., UL 746 B)	130 °C
Fire protection for rail vehicles (DIN EN 45545-2) R22	HL 1 - HL 3
Fire protection for rail vehicles (DIN EN 45545-2) R23	HL 1 - HL 3
Fire protection for rail vehicles (DIN EN 45545-2) R24	HL 1 - HL 3
Fire protection for rail vehicles (DIN EN 45545-2) R26	HL 1 - HL 3
Calorimetric heat release NFPA 130 (ASTM E 1354)	27,5 MJ/kg
Surface flammability NFPA 130 (ASTM E 162)	passed
Specific optical density of smoke NFPA 130 (ASTM E 662)	passed
Smoke gas toxicity NFPA 130 (SMP 800C)	passed

Mechanical properties

Mechanical data

Open side panel	No
-----------------	----

Technical data

Drill hole spacing	108 mm
--------------------	--------

Environmental and real-life conditions

Ambient conditions

Ambient temperature (operation)	-60 °C ... 110 °C (Operating temperature range incl. self-heating; for max. short-term operating temperature, see RTI Elec.)
Ambient temperature (storage/transport)	-25 °C ... 60 °C (for a short time, not exceeding 24 h, -60 °C to +70 °C)
Ambient temperature (assembly)	-5 °C ... 70 °C
Ambient temperature (actuation)	-5 °C ... 70 °C
Permissible humidity (operation)	20 % ... 90 %
Permissible humidity (storage/transport)	30 % ... 70 %

Mounting

Mounting type	direct screw connection
---------------	-------------------------

PPOWER 35-3L/FE-F - High-current terminal block

3212075

<https://www.phoenixcontact.com/us/products/3212075>



Drawings

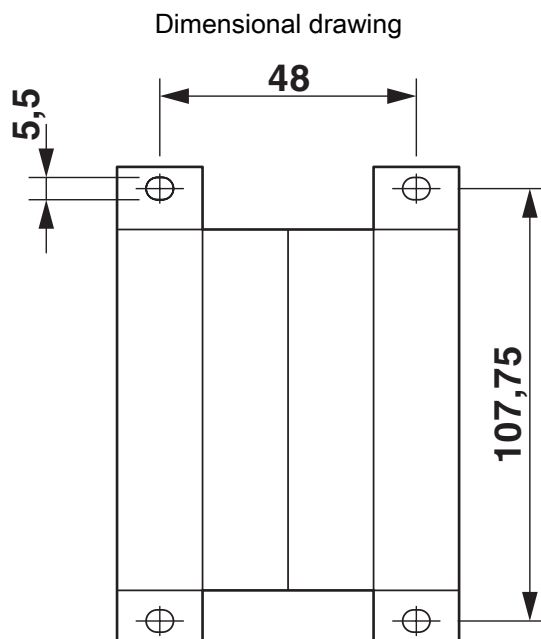

PTPOWER 35-3L/FE-F - High-current terminal block

3212075

<https://www.phoenixcontact.com/us/products/3212075>

Schematic diagram

PTPOWER



AGK 10-PTPOWER	0,5 mm ² ... 16 mm ²	18 mm
PTPOWER 35	2,5 mm ² ... 35 mm ²	25 mm
PTPOWER 50	10 mm ² ... 50 mm ²	32 mm
PTPOWER 95	25 mm ² ... 95 mm ²	40 mm
PTPOWER 185	95 mm ² ... 185 mm ²	40 mm

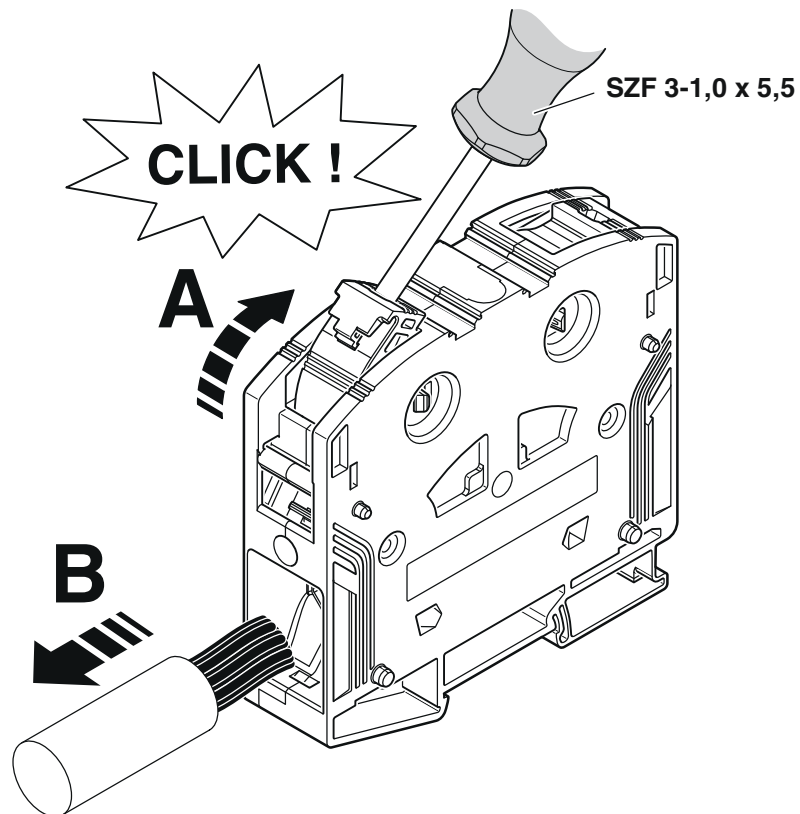

Circuit diagram

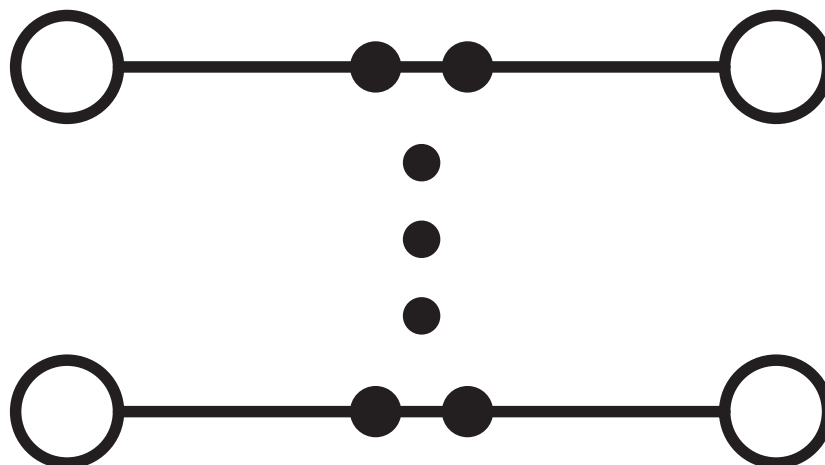

PTPOWER 35-3L/FE-F - High-current terminal block





3212075

<https://www.phoenixcontact.com/us/products/3212075>

Approvals

To download certificates, visit the product detail page: <https://www.phoenixcontact.com/us/products/3212075>

 CSA Approval ID: 13631				
	Nominal voltage U_N	Nominal current I_N	Cross section AWG	Cross section mm^2
B	600 V	115 A	14 - 2	-
C	1000 V	115 A	14 - 2	-

 EAC Approval ID: RU C-DE.BL08.B.00644				
-----------------------------------------------------------------------------------------------------------------------------------	--	--	--	--

DNV Approval ID: TAE0000029				
---------------------------------------	--	--	--	--

 cUL Recognized Approval ID: E60425				
	Nominal voltage U_N	Nominal current I_N	Cross section AWG	Cross section mm^2
C	1000 V	115 A	14 - 2	-

 UL Recognized Approval ID: E60425				
	Nominal voltage U_N	Nominal current I_N	Cross section AWG	Cross section mm^2
E	1000 V	115 A	14 - 2	-

 EAC Approval ID: KZ7500651131219505				
-----------------------------------------------------------------------------------------------------------------------------------	--	--	--	--

 UKCA-EX Approval ID: CML 22UKEX1227U				
------------------------------------------------------------------------------------------------------------------------------------	--	--	--	--

 IECEx Approval ID: IECExSEV14.0013U				
	Nominal voltage U_N	Nominal current I_N	Cross section AWG	Cross section mm^2
keine				

PPOWER 35-3L/FE-F - High-current terminal block



3212075

<https://www.phoenixcontact.com/us/products/3212075>

Only rigid conductors	690 V	109 A	-	2.5 - 35
multi-stranded with ferrule	690 V	109 A	-	6 - 35



ATEX

Approval ID: SEV14ATEX0156U

	Nominal voltage U_N	Nominal current I_N	Cross section AWG	Cross section mm^2
keine				
Only rigid conductors	690 V	109 A	-	2.5 - 35
multi-stranded with ferrule	690 V	109 A	-	6 - 35

PTPOWER 35-3L/FE-F - High-current terminal block



3212075

<https://www.phoenixcontact.com/us/products/3212075>

Classifications

ECLASS

ECLASS-13.0	27250101
ECLASS-15.0	27250101

ETIM

ETIM 10.0	EC000897
-----------	----------

UNSPSC

UNSPSC 21.0	39121400
-------------	----------

PTPOWER 35-3L/FE-F - High-current terminal block



3212075

<https://www.phoenixcontact.com/us/products/3212075>

Environmental product compliance

EU RoHS

Fulfills EU RoHS substance requirements	Yes, No exemptions
-----------------------------------------	--------------------

China RoHS

Environment friendly use period (EFUP)	EFUP-E
	No hazardous substances above the limits

EU REACH SVHC

REACH candidate substance (CAS No.)	No substance above 0.1 wt%
-------------------------------------	----------------------------

Phoenix Contact 2026 © - all rights reserved
<https://www.phoenixcontact.com>

Phoenix Contact USA
586 Fulling Mill Road
Middletown, PA 17057, United States
(+717) 944-1300
info@phoenixcon.com