

# ST 2,5/2P - Feed-through terminal block



3042133

<https://www.phoenixcontact.com/us/products/3042133>

Please be informed that the data shown in this PDF document is generated from our online catalog. Please find the complete data in the user documentation. Our general terms of use for downloads are valid.

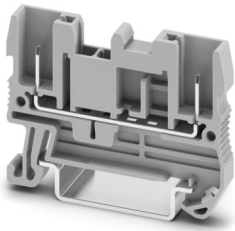

Feed-through terminal block, nom. voltage: 500 V, nominal current: 24 A, number of connections: 2, connection method: Plug-in connection, Rated cross section: 2.5 mm<sup>2</sup>, 1 level, cross section: 0.08 mm<sup>2</sup> - 4 mm<sup>2</sup>, mounting type: NS 35/7,5, NS 35/15, color: gray

## Your advantages

- Tested for railway applications
- Connection with standard COMBI plugs

## Commercial data

Item number	3042133
Packing unit	50 pc
Minimum order quantity	50 pc
Sales key	BE02
Product key	BE2141
GTIN	4017918936051
Weight per piece (including packing)	5.16 g
Weight per piece (excluding packing)	4.7 g
Customs tariff number	85369010
Country of origin	DE

# ST 2,5/2P - Feed-through terminal block



3042133

<https://www.phoenixcontact.com/us/products/3042133>

## Technical data

### Product properties

Product type	Plug-in terminal block
Product family	ST
Area of application	Railway industry
	Machine building
	Plant engineering
Number of connections	2
Number of rows	1
Potentials	1

### Insulation characteristics

Overvoltage category	III
Degree of pollution	3

### Electrical properties

Rated surge voltage	6 kV
Maximum power dissipation for nominal condition	0.77 W

### Connection data

Number of connections per level	2
Nominal cross section	2.5 mm <sup>2</sup>

#### 1 level

Connection method	Plug-in connection
Internal cylindrical gage	A3
Connection in acc. with standard	IEC 61984
Conductor cross-section rigid	0.08 mm <sup>2</sup> ... 4 mm <sup>2</sup>
Cross section AWG	28 ... 12 (converted acc. to IEC)
Conductor cross-section flexible	0.08 mm <sup>2</sup> ... 2.5 mm <sup>2</sup>
Conductor cross-section, flexible [AWG]	28 ... 14 (converted acc. to IEC)
Conductor cross-section flexible ultrasound-compressed	0.34 mm <sup>2</sup> ... 4 mm <sup>2</sup>
Conductor cross-section, flexible [AWG] ultrasound-compressed	22 ... 12 (converted acc. to IEC)
Conductor cross-section flexible (ferrule without plastic sleeve)	0.14 mm <sup>2</sup> ... 2.5 mm <sup>2</sup>
Flexible conductor cross-section (ferrule with plastic sleeve)	0.14 mm <sup>2</sup> ... 2.5 mm <sup>2</sup>
2 conductors with the same cross section, flexible, with TWIN ferrule with plastic sleeve	0.5 mm <sup>2</sup>
Nominal cross section	2.5 mm <sup>2</sup>
Nominal current	24 A
Maximum load current	24 A (with 4 mm <sup>2</sup> conductor cross-section)
Nominal voltage	500 V

### Dimensions

# ST 2,5/2P - Feed-through terminal block

3042133

<https://www.phoenixcontact.com/us/products/3042133>

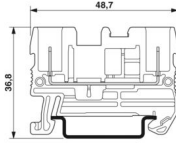
Dimensional drawing	
Width	5.2 mm
End cover width	2.2 mm
Height	49.1 mm
Depth on NS 35/7,5	36.5 mm
Depth on NS 35/15	44 mm

## Material specifications

Color	gray (RAL 7042)
Flammability rating according to UL 94	V0
Insulating material group	I
Insulating material	PA
Static insulating material application in cold	-60 °C
Temperature index of insulation material (DIN EN 60216-1 (VDE 0304-21))	125 °C
Relative insulation material temperature index (Elec., UL 746 B)	130 °C
Fire protection for rail vehicles (DIN EN 45545-2) R22	HL 1 - HL 3
Fire protection for rail vehicles (DIN EN 45545-2) R23	HL 1 - HL 3
Fire protection for rail vehicles (DIN EN 45545-2) R24	HL 1 - HL 3
Fire protection for rail vehicles (DIN EN 45545-2) R26	HL 1 - HL 3
Calorimetric heat release NFPA 130 (ASTM E 1354)	27,5 MJ/kg
Surface flammability NFPA 130 (ASTM E 162)	passed
Specific optical density of smoke NFPA 130 (ASTM E 662)	passed
Smoke gas toxicity NFPA 130 (SMP 800C)	passed

## Electrical tests

### Surge voltage test

Test voltage setpoint	7.3 kV
Result	Test passed
Short-time withstand current 2.5 mm <sup>2</sup>	0.3 kA
Result	Test passed

### Power-frequency withstand voltage

Test voltage setpoint	1.89 kV
Result	Test passed

## Mechanical properties

### Mechanical data

Open side panel	Yes
-----------------	-----

# ST 2,5/2P - Feed-through terminal block



3042133

<https://www.phoenixcontact.com/us/products/3042133>

## Mechanical tests

### Attachment on the carrier

DIN rail/fixing support	NS 35
Test force setpoint	1 N
Result	Test passed

## Environmental and real-life conditions

### Needle-flame test

Time of exposure	30 s
Result	Test passed

### Oscillation/broadband noise

Specification	DIN EN 50155 (VDE 0115-200):2008-03
Spectrum	Long life test category 1, class B, body mounted
Frequency	$f_1 = 5 \text{ Hz}$ to $f_2 = 150 \text{ Hz}$
ASD level	$0.964 \text{ (m/s}^2\text{)}^2\text{/Hz}$
Acceleration	0.58g
Test duration per axis	5 h
Test directions	X-, Y- and Z-axis
Result	Test passed

### Shocks

Specification	DIN EN 50155 (VDE 0115-200):2008-03
Pulse shape	Half-sine
Acceleration	5g
Shock duration	30 ms
Number of shocks per direction	3
Test directions	X-, Y- and Z-axis (pos. and neg.)
Result	Test passed

### Ambient conditions

Ambient temperature (operation)	-60 °C ... 100 °C (max. operating temperature range including self-heating, see derating curve)
Ambient temperature (storage/transport)	-25 °C ... 60 °C (for a short time, not exceeding 24 h, -60 °C to +70 °C)
Ambient temperature (assembly)	-5 °C ... 70 °C
Ambient temperature (actuation)	-5 °C ... 70 °C
Permissible humidity (operation)	20 % ... 90 %
Permissible humidity (storage/transport)	30 % ... 70 %

## Standards and regulations

Connection in acc. with standard	IEC 61984
----------------------------------	-----------

## Mounting

# ST 2,5/2P - Feed-through terminal block



3042133

<https://www.phoenixcontact.com/us/products/3042133>

Mounting type	NS 35/7,5
	NS 35/15

# ST 2,5/2P - Feed-through terminal block

3042133

<https://www.phoenixcontact.com/us/products/3042133>

## Drawings

Dimensional drawing

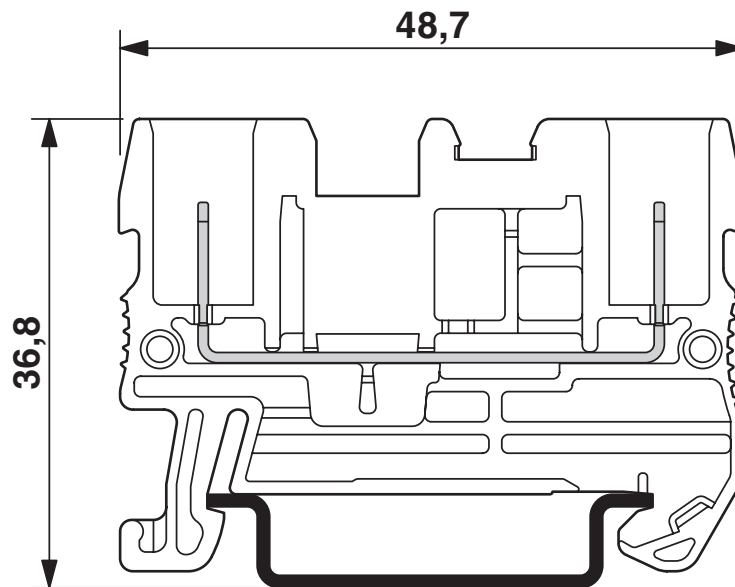

Diagram

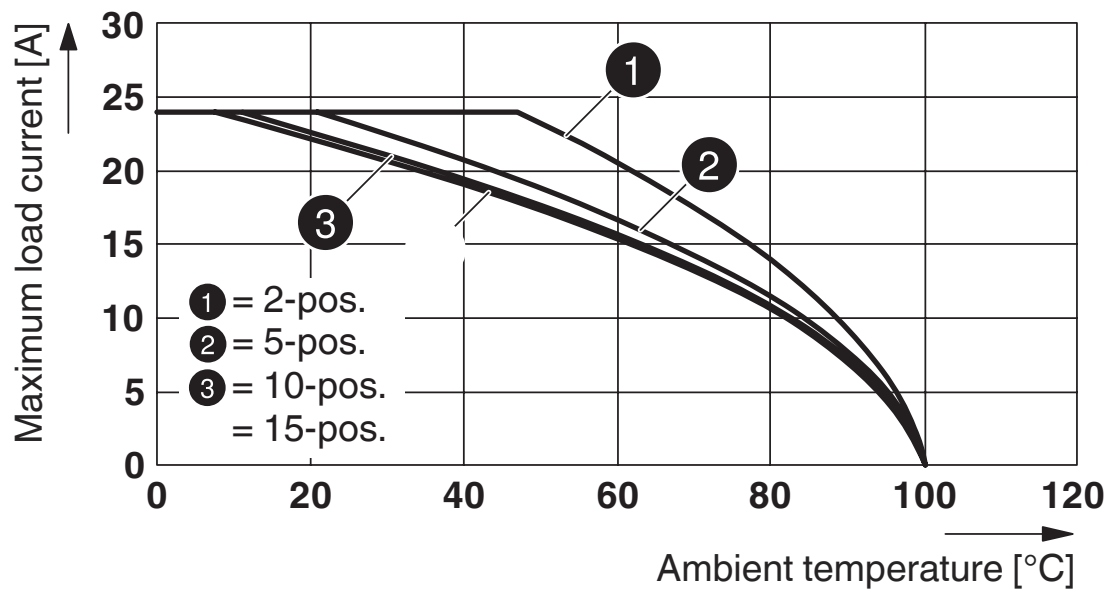

# ST 2,5/2P - Feed-through terminal block



3042133

<https://www.phoenixcontact.com/us/products/3042133>

Circuit diagram

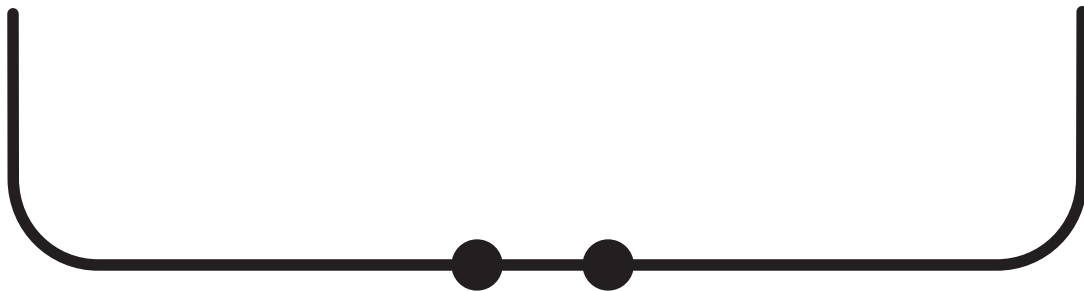

# ST 2,5/2P - Feed-through terminal block



3042133

<https://www.phoenixcontact.com/us/products/3042133>

## Approvals

To download certificates, visit the product detail page: <https://www.phoenixcontact.com/us/products/3042133>

 <b>CSA</b> Approval ID: 13631				
	Nominal voltage $U_N$	Nominal current $I_N$	Cross section AWG	Cross section $mm^2$
B	300 V	20 A	28 - 12	-
C	300 V	20 A	28 - 12	-
D	600 V	5 A	28 - 12	-

 <b>IECEE CB Scheme</b> Approval ID: DE1-62736/B1/B2				
--	--	--	--	--

 <b>EAC</b> Approval ID: RU C-DE.BL08.B.00644				
---	--	--	--	--

 <b>VDE Zeichengenehmigung</b> Approval ID: 40019518				
	Nominal voltage $U_N$	Nominal current $I_N$	Cross section AWG	Cross section $mm^2$
keine				
Current depends on number of positions	500 V	-	-	0.2 - 2.5

 <b>cULus Recognized</b> Approval ID: E60425				
	Nominal voltage $U_N$	Nominal current $I_N$	Cross section AWG	Cross section $mm^2$
B	300 V	20 A	-	-
C	300 V	20 A	-	-
D	600 V	5 A	-	-
F	500 V	20 A	-	-

<b>DNV</b> Approval ID: TAE00001CS				
---------------------------------------	--	--	--	--

# ST 2,5/2P - Feed-through terminal block

3042133

<https://www.phoenixcontact.com/us/products/3042133>



**EAC**

Approval ID: KZ7500651131219505

# ST 2,5/2P - Feed-through terminal block



3042133

<https://www.phoenixcontact.com/us/products/3042133>

## Classifications

### ECLASS

ECLASS-13.0	27250117
ECLASS-15.0	27250117

### ETIM

ETIM 10.0	EC000897
-----------	----------

### UNSPSC

UNSPSC 21.0	39121400
-------------	----------

# ST 2,5/2P - Feed-through terminal block



3042133

<https://www.phoenixcontact.com/us/products/3042133>

## Environmental product compliance

### EU RoHS

Fulfills EU RoHS substance requirements	Yes, No exemptions
---	--------------------

### China RoHS

Environment friendly use period (EFUP)	EFUP-E
	No hazardous substances above the limits

### EU REACH SVHC

REACH candidate substance (CAS No.)	No substance above 0.1 wt%
-------------------------------------	----------------------------

### EF3.1 Climate Change

CO2e kg	0.024 kg CO2e
---------	---------------

Phoenix Contact 2026 © - all rights reserved  
<https://www.phoenixcontact.com>

Phoenix Contact USA  
586 Fulling Mill Road  
Middletown, PA 17057, United States  
(+717) 944-1300  
[info@phoenixcon.com](mailto:info@phoenixcon.com)