

RIF-2-RPT-LDP-24DC/4X21/EX - Relay module



2909741

<https://www.phoenixcontact.com/us/products/2909741>

Please be informed that the data shown in this PDF document is generated from our online catalog. Please find the complete data in the user documentation. Our general terms of use for downloads are valid.



Pre-assembled relay module consisting of: relay base, function plug-in module, power contact relay, and retaining bracket, approval in accordance with ATEX/IECEX (Zone 2) and Ex Zone Class I, Div. 2, Push-in connection, 4 changeover contacts, Freewheeling diode, Input voltage: 24 V DC

Product description

The pluggable electromechanical and solid-state relays in the RIFLINE complete product range and the base are recognized and approved in accordance with UL 508. The relevant approvals can be called up at the individual components in question.

Commercial data

Item number	2909741
Packing unit	10 pc
Minimum order quantity	10 pc
Sales key	C465
Product key	DK652A
GTIN	4055626379913
Weight per piece (including packing)	109.63 g
Weight per piece (excluding packing)	109.63 g
Customs tariff number	85364110
Country of origin	CN

RIF-2-RPT-LDP-24DC/4X21/EX - Relay module



2909741

<https://www.phoenixcontact.com/us/products/2909741>

Set consists of

RIF-2-BPT/4X21/EX - Relay base

1047028

<https://www.phoenixcontact.com/us/products/1047028>



RIF-2.../EX relay base for assembling with RTIII-sealed industrial relays with 4 changeover contacts for use in zone 2, Push-in connection, plug-in option for input / interference suppression modules, for mounting on NS 35/7,5

RIF-LDP-12-24 DC - Plug-in module

2900939

<https://www.phoenixcontact.com/us/products/2900939>



Plug-in module, for mounting on RIF-1, RIF-2, RIF-3, and RIF-4, with freewheeling diode and yellow LED, polarity: A1+, A2-, input voltage: 12 V DC ... 24 V DC $\pm 30\%$

RIF-2-RPT-LDP-24DC/4X21/EX - Relay module



2909741

<https://www.phoenixcontact.com/us/products/2909741>

RIF-RH-2 - Retaining bracket

2900954

<https://www.phoenixcontact.com/us/products/2900954>



Relay retaining bracket, with ejector function and holder for marking material, suitable for RIF-2 relay base, for industrial relay

Technical data

Notes

Utilization restriction

EMC note	EMC: class A product, see manufacturer's declaration in the download area
----------	---------------------------------------------------------------------------

Product properties

Product type	Relay Module
Product family	RIFLINE complete
Application	Class I, Division 2 potentially explosive areas
Operating mode	100% operating factor
Mechanical service life	approx. 2×10^7 cycles

Insulation characteristics

Insulation	Basic insulation
Overvoltage category	III II (Zone 2)

Data management status

Date of last data management	20.01.2026
------------------------------	------------

Electrical properties

Maximum power dissipation for nominal condition	1.01 W
Test voltage (Winding/contact)	2.5 kV _{rms} (50 Hz, 1 min., winding/contact)
Test voltage (Contact/contact)	2 kV _{rms} (50 Hz, 1 min., contact/contact)
Rated insulation voltage	250 V AC
Rated surge voltage	2.5 kV

Input data

Coil side

Nominal input voltage U_N	24 V DC
Input voltage range	19.2 V DC ... 30 V DC (20 °C)
Input voltage range in reference to U_N	see diagram
Drive and function	monostable
Drive (polarity)	polarized
Typical input current at U_N	42 mA
Typical response time	13 ms
Typical release time	14 ms
Coil voltage	24 V DC
Protective circuit	Freewheeling diode
Operating voltage display	Yellow LED

RIF-2-RPT-LDP-24DC/4X21/EX - Relay module



2909741

<https://www.phoenixcontact.com/us/products/2909741>

Output data

Switching

Contact switching type	4 changeover contacts
Type of switch contact	Single contact
Contact material	AgNi
Maximum switching voltage	250 V AC/DC
Minimum switching voltage	5 V (24 mA)
Limiting continuous current	6 A (see diagram)
Maximum inrush current	16 A (20 ms, N/O contacts)
Min. switching current	5 mA (24 V)
Interrupting rating (ohmic load) max.	144 W (at 24 V DC) 124 W (at 48 V DC) 108 W (at 60 V DC) 52 W (at 110 V DC) 48 W (at 220 V DC) 1500 VA (for 250 V AC)
Switching capacity	2 A (at 24 V, DC13) 0.22 A (at 120 V, DC13) 0.11 A (at 250 V, DC13) 1.5 A (at 24 V, AC15) 1.5 A (at 120 V, AC15) 1 A (at 240 V, AC15)

Connection data

Connection method	Push-in connection
Stripping length	8 mm
Conductor cross-section rigid	0.14 mm ² ... 1.5 mm ²
Conductor cross-section flexible	0.14 mm ² ... 1.5 mm ² 0.14 mm ² ... 1.5 mm ² (Ferrule with plastic sleeve) 0.14 mm ² ... 1 mm ² (Ferrule with plastic sleeve, two conductors on double terminal block)
Conductor cross-section AWG	26 ... 16 (solid) 26 ... 16 (flexible)

Dimensions

Item dimensions

Width	31 mm
Height	96 mm
Depth	75 mm

Drill hole

Diameter	3.2 mm
----------	--------

RIF-2-RPT-LDP-24DC/4X21/EX - Relay module



2909741

<https://www.phoenixcontact.com/us/products/2909741>

Material specifications

Color	gray (RAL 7042)
Flammability rating according to UL 94 (Housing)	V2 (Housing)

Environmental and real-life conditions

Ambient conditions

Degree of protection (Relay base)	IP20 (Relay base)
Degree of protection (Relay)	RT III (Relay)
Ambient temperature (operation)	-40 °C ... 60 °C
Ambient temperature (storage/transport)	-40 °C ... 85 °C

Approvals

ATEX

Identification	⊕ II 3G Ex ec nC IIC T4 Gc
Certificate	IBExU17ATEXB014X

UKCA Ex (UKEX)

Identification	⊕ II 3G Ex ec nC IIC T4 Gc
Certificate	PxclF21UKEX2909741X

IECEX

Identification	Ex ec nC IIC T4 Gc
Certificate	IECEX IBE 17.0032X

UL, USA/Canada

Identification	Class I, Div. 2, Groups A, B, C, D T4
	Class I, Zone 2, Group IIC

Corrosive gas test

Identification	ISA-S71.04. G3 Harsh Group
	EN 60068-2-60

Standards and regulations

Standards/regulations	IEC 60947-5-1
	IEC 61508-1

Ex zone

Standards/regulations	EN/IEC 60079-0
	EN/IEC 60079-7
	EN/IEC 60079-15

Mounting

Mounting type	DIN rail mounting
Assembly note	in rows with zero spacing
Mounting position	any

Drawings

Diagram



- ① DC coil (observe contact derating)
- ② AC coil (observe contact derating)

Operating voltage range

Diagram



- ① AC, ohmic load
- ② DC, ohmic load

Interrupting rating

Diagram



Contact derating

Diagram

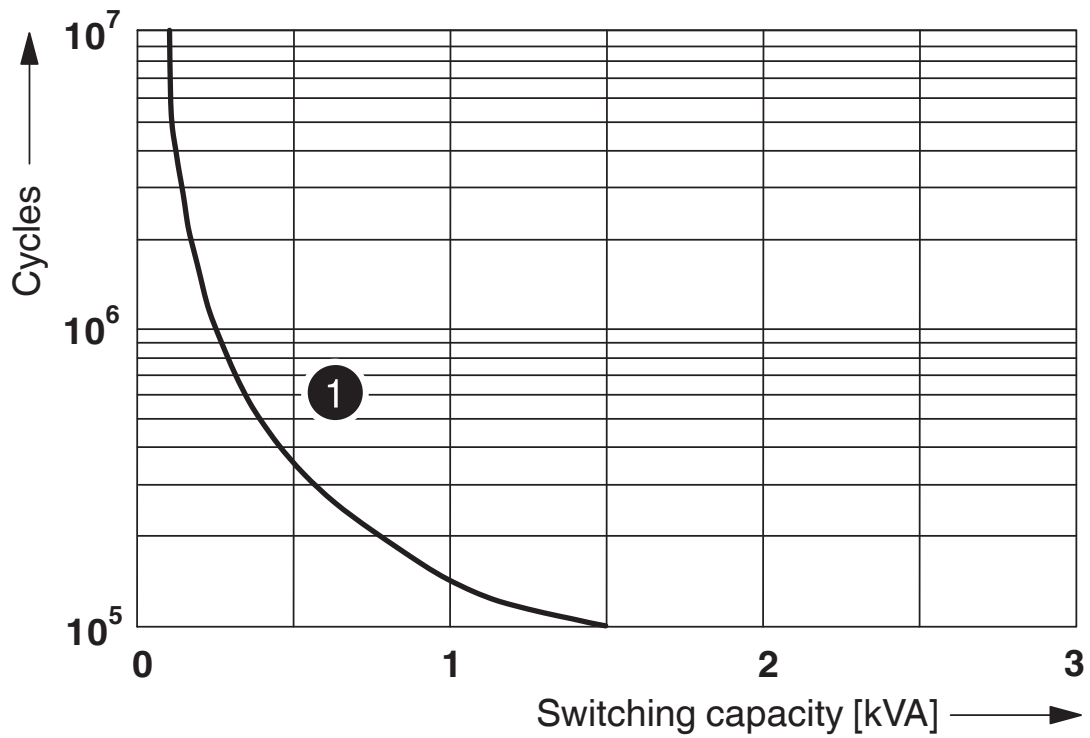

① 250 V AC, Ohmic load

Electrical service life

Diagram



Service life reduction factor



Permissible humidity for operation and storage.

The maximum permissible ambient temperature as specified in the data sheet must be observed.

Area A: Ice buildup at ambient temperatures $\leq 0^\circ\text{C}$ must be prevented

Area B: Condensation at ambient temperatures $> 0^\circ\text{C}$ must be prevented

On 30 full days that are naturally distributed across an entire year, a humidity level of 95% is permissible at an ambient temperature $\leq 25^\circ\text{C}$.

Circuit diagram

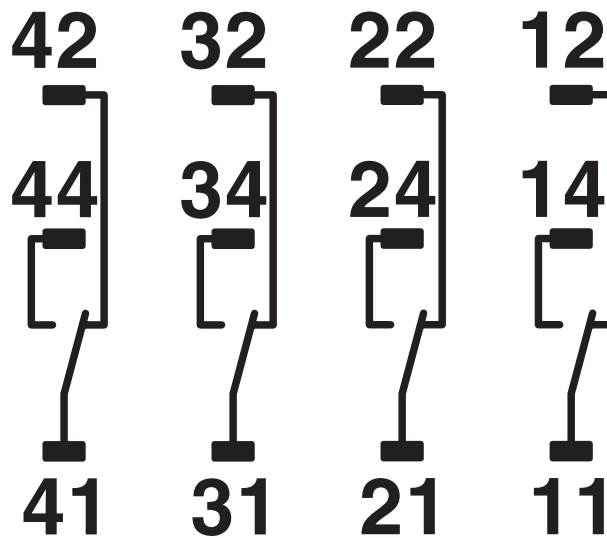

DC coils

RIF-2-RPT-LDP-24DC/4X21/EX - Relay module



2909741

<https://www.phoenixcontact.com/us/products/2909741>

Approvals

To download certificates, visit the product detail page: <https://www.phoenixcontact.com/us/products/2909741>



UL Listed

Approval ID: E238705



cUL Listed

Approval ID: E238705



IECEX

Approval ID: IECEX IBE 17.0032X



cUL Listed

Approval ID: File E 196811



UL Listed

Approval ID: File E 196811



ATEX

Approval ID: IBExU 17 ATEX B014 X

RIF-2-RPT-LDP-24DC/4X21/EX - Relay module



2909741

<https://www.phoenixcontact.com/us/products/2909741>

Classifications

ECLASS

ECLASS-13.0	27371601
ECLASS-15.0	27371601

ETIM

ETIM 10.0	EC001437
-----------	----------

UNSPSC

UNSPSC 21.0	39122300
-------------	----------

2909741

<https://www.phoenixcontact.com/us/products/2909741>

Environmental product compliance

EU RoHS

Fulfills EU RoHS substance requirements	Yes
Exemption	7(a), 7(c)-I

China RoHS

Environment friendly use period (EFUP)	EFUP-50
	An article-related China RoHS declaration table can be found in the download area for the respective article under "Manufacturer declaration". For all articles with EFUP-E, no China RoHS declaration table issued and required.

EU REACH SVHC

REACH candidate substance (CAS No.)	Lead(CAS: 7439-92-1)
SCIP	0bb6470c-39ec-4690-9317-c1f04e8dbf8c

Phoenix Contact 2026 © - all rights reserved

<https://www.phoenixcontact.com>

Phoenix Contact USA
586 Fulling Mill Road
Middletown, PA 17057, United States
(+717) 944-1300
info@phoenixcon.com