

TMC 82D 05A - Miniature Circuit Breaker



2907655

<https://www.phoenixcontact.com/us/products/2907655>

Please be informed that the data shown in this PDF document is generated from our online catalog. Please find the complete data in the user documentation. Our general terms of use for downloads are valid.



Thermal-magnetic Miniature Circuit Breaker, 2-position, use: Branch Circuit Protection (UL 489), for protection against overload with a breaking capacity of 10 kA, tripping characteristic: D, mounting type: NS 35/..., rated current: 5 A

Product description

CCC marking on the product is only present on products purchased from Phoenix Contact China.

Your advantages

- Can be used worldwide due to international approvals
- Suitable for various grid types, as it is available in 1-, 2-, 3-pos. versions
- Ideally coordinated protection due to various tripping characteristics and a wide selection of nominal currents
- Reduced inventory because of suitability for AC and DC applications
- Optional accessories enable remote control and monitoring

Commercial data

Item number	2907655
Packing unit	6 pc
Minimum order quantity	1 pc
Sales key	CL08
Product key	CLA125
GTIN	4055626215822
Weight per piece (including packing)	282.5 g
Weight per piece (excluding packing)	262 g
Customs tariff number	85362010
Country of origin	CN

TMC 82D 05A - Miniature Circuit Breaker



2907655

<https://www.phoenixcontact.com/us/products/2907655>

Technical data

Product properties

Product type	Circuit breakers
Product family	TMC 8
Type	DIN rail module, one-piece
Number of positions	2
Mechanical service life	20000
Special properties	Branch Circuit Protection (UL 489), for protection against overload with a breaking capacity of 10 kA Thermal-magnetic

Electrical properties

Service life electrical	6000
-------------------------	------

General

Operating voltage	277 V AC (277/480Y, 240D, 120/240S) 125 V DC (two poles in series)
Rated current I_N	5 A
Tripping method	TM (thermal-magnetic)
Rated short-circuit switching capacity I_{cn}	10 kA (IC)
Fuse	D
Contact switching type	none

Connection data

Conductor cross-section rigid	1 mm ² ... 35 mm ²
Cross section AWG	18 ... 2 (converted acc. to IEC)
Conductor cross-section flexible	1 mm ² ... 35 mm ²
Connection method	Screw connection
Tightening torque, min	2 Nm
Tightening torque	2 Nm
Stripping length	11 mm ... 12 mm
Conductor cross-section flexible max.	35 mm ²
Conductor cross-section, rigid max.	35 mm ²
Conductor cross-section flexible	1 mm ² ... 35 mm ²
Conductor cross-section rigid	1 mm ² ... 35 mm ²
Conductor cross-section AWG	18 ... 2

Dimensions

Dimensional drawing	
Width	35.3 mm
Height	116 mm

TMC 82D 05A - Miniature Circuit Breaker



2907655

<https://www.phoenixcontact.com/us/products/2907655>

Depth	76.6 mm (incl. DIN rail 7.5 mm)
-------	---------------------------------

Material specifications

Color	light gray (RAL 7035)
	gray (RAL 7042)

Environmental and real-life conditions

Ambient conditions

Ambient temperature (operation)	-35 °C ... 70 °C
Humidity test	48 h, 95% RH, 40°C (IEC 60068-2-78)
Shock (operation)	30g (11 ms) (IEC 60068-2-11)
Vibration (operation)	±0,38 mm (10 Hz ... 57 Hz), 5g (57 Hz ... 500 Hz) (IEC 60068-2-6, Fc, sine)

Standards and regulations

Standards/specifications	UL 489
	IEC 60947-2

Mounting

Mounting type	NS 35/...
---------------	-----------

TMC 82D 05A - Miniature Circuit Breaker

2907655

<https://www.phoenixcontact.com/us/products/2907655>



Drawings

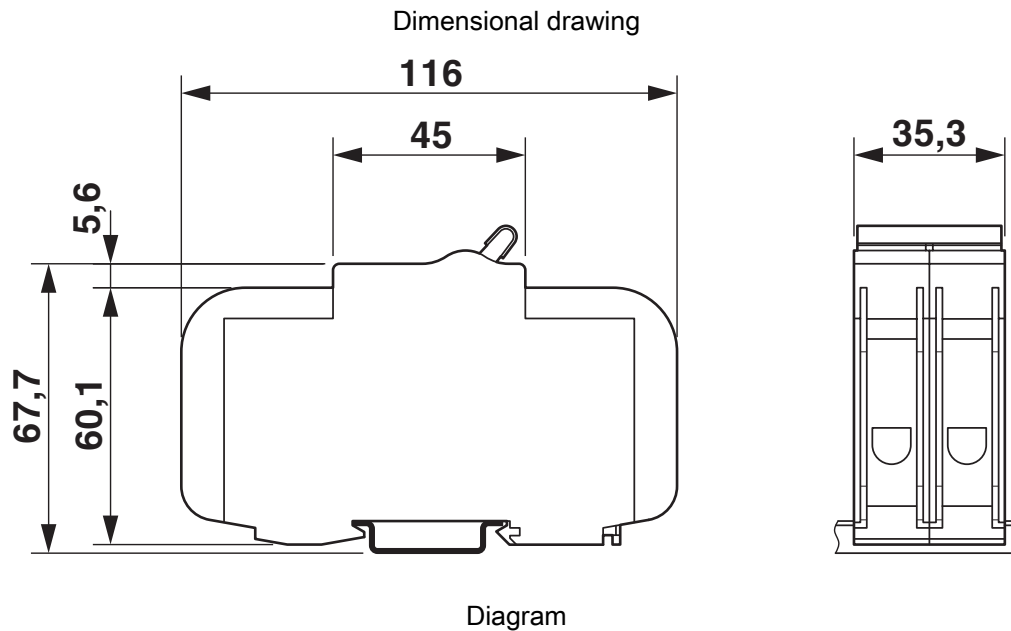

TMC 82D 05A - Miniature Circuit Breaker



2907655

<https://www.phoenixcontact.com/us/products/2907655>

Approvals

To download certificates, visit the product detail page: <https://www.phoenixcontact.com/us/products/2907655>



UL Listed

Approval ID: FILE E 320373



cUL Listed

Approval ID: FILE E 320373



TÜV Rheinland

Approval ID: R 50531587



CCC

Approval ID: 2024010307673885

TMC 82D 05A - Miniature Circuit Breaker



2907655

<https://www.phoenixcontact.com/us/products/2907655>

Classifications

ECLASS

ECLASS-13.0	27140401
ECLASS-15.0	27140401

ETIM

ETIM 10.0	EC003538
-----------	----------

UNSPSC

UNSPSC 21.0	39121410
-------------	----------

TMC 82D 05A - Miniature Circuit Breaker



2907655

<https://www.phoenixcontact.com/us/products/2907655>

Environmental product compliance

EU RoHS

Fulfills EU RoHS substance requirements	Yes, No exemptions
---	--------------------

China RoHS

Environment friendly use period (EFUP)	EFUP-E
	No hazardous substances above the limits

EU REACH SVHC

REACH candidate substance (CAS No.)	No substance above 0.1 wt%
-------------------------------------	----------------------------

Phoenix Contact 2026 © - all rights reserved
<https://www.phoenixcontact.com>

Phoenix Contact USA
586 Fulling Mill Road
Middletown, PA 17057, United States
(+717) 944-1300
info@phoenixcon.com