

# HMC 11 120AC 5A C1D2 TBUS - Hydraulic-magnetic circuit breaker



2907203

<https://www.phoenixcontact.com/us/products/2907203>

Please be informed that the data shown in this PDF document is generated from our online catalog. Please find the complete data in the user documentation. Our general terms of use for downloads are valid.

HMC series of supplemental circuit protector busbar modules, 5 A rating



## Your advantages

- T-bus for up to 15 A power distribution
- UL recognized for hazardous locations Class I, Division 2, Groups A, B, C, and D
- Dual-rated for 50 V DC and 120 V AC
- Hydraulic-magnetic technology provides extended temperature stability

## Commercial data

Item number	2907203
Packing unit	1 pc
Minimum order quantity	1 pc
Sales key	CL12
Product key	CLA181
GTIN	4055626342450
Weight per piece (including packing)	222.222 g
Weight per piece (excluding packing)	11.793 g
Country of origin	US

# HMC 11 120AC 5A C1D2 TBUS - Hydraulic-magnetic circuit breaker



2907203

<https://www.phoenixcontact.com/us/products/2907203>

## Technical data

### Notes

#### Trade restriction

CE note	The products are offered exclusively for export outside the EU and the European Economic Area.
---------	--

### Product properties

Product type	Device circuit breakers
Product family	HMC
Number of positions	1
Number of rows	1

### Electrical properties

#### General

Nominal current $I_N$	5 A
Rated voltage	120 V AC (50/60 Hz)
	50 V DC
Rated short-circuit switching capacity $I_{cn}$	1 kA (SCCR)
Fuse	Hydraulic magnetic circuit breaker

### Connection data

Connection method	Screw connection with tension sleeve
Screw thread	M3
Tightening torque	0.5 ... 0.6 Nm
Stripping length	7 mm
Conductor cross-section rigid	0.2 mm <sup>2</sup> ... 2.5 mm <sup>2</sup>
Cross section AWG	24 ... 12 (converted acc. to IEC)
Conductor cross-section flexible	0.2 mm <sup>2</sup> ... 2.5 mm <sup>2</sup>
Conductor cross-section, flexible [AWG]	24 ... 12 (converted acc. to IEC)

### Dimensions

Dimensional drawing	
Width	29.2 mm
Height	109.2 mm
Depth	93.6 mm

# HMC 11 120AC 5A C1D2 TBUS - Hydraulic-magnetic circuit breaker



2907203

<https://www.phoenixcontact.com/us/products/2907203>

## Material specifications

Color	light gray (RAL 7035)
Material	Polyamide
Flammability rating according to UL 94	V0

## Environmental and real-life conditions

### Ambient conditions

Ambient temperature (operation)	-40 °C ... 65 °C
Ambient temperature (storage/transport)	-40 °C ... 65 °C

## Standards and regulations

Standards/specifications	UL 1077
--------------------------	---------

## Mounting

Mounting type	DIN rail: 35 mm
Mounting position	As desired on 35 mm DIN rail in acc. with EN 60715

# HMC 11 120AC 5A C1D2 TBUS - Hydraulic-magnetic circuit breaker



2907203

<https://www.phoenixcontact.com/us/products/2907203>

## Drawings

Dimensional drawing

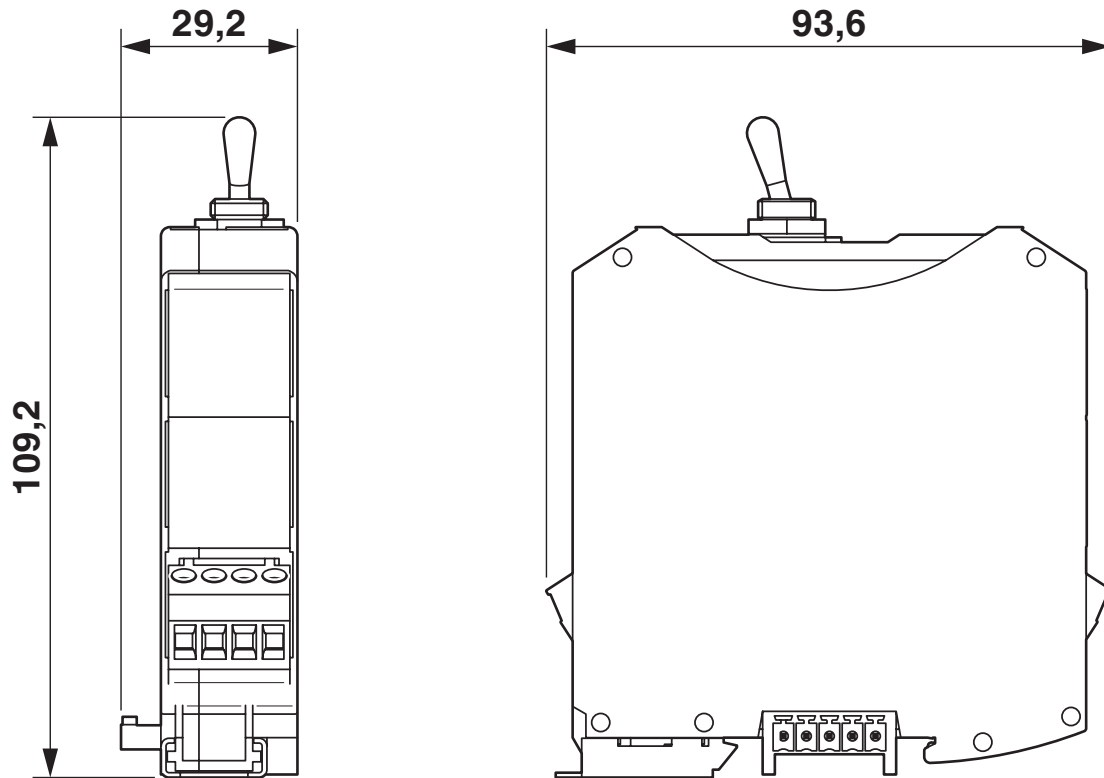

# HMC 11 120AC 5A C1D2 TBUS - Hydraulic-magnetic circuit breaker



2907203

<https://www.phoenixcontact.com/us/products/2907203>

Diagram

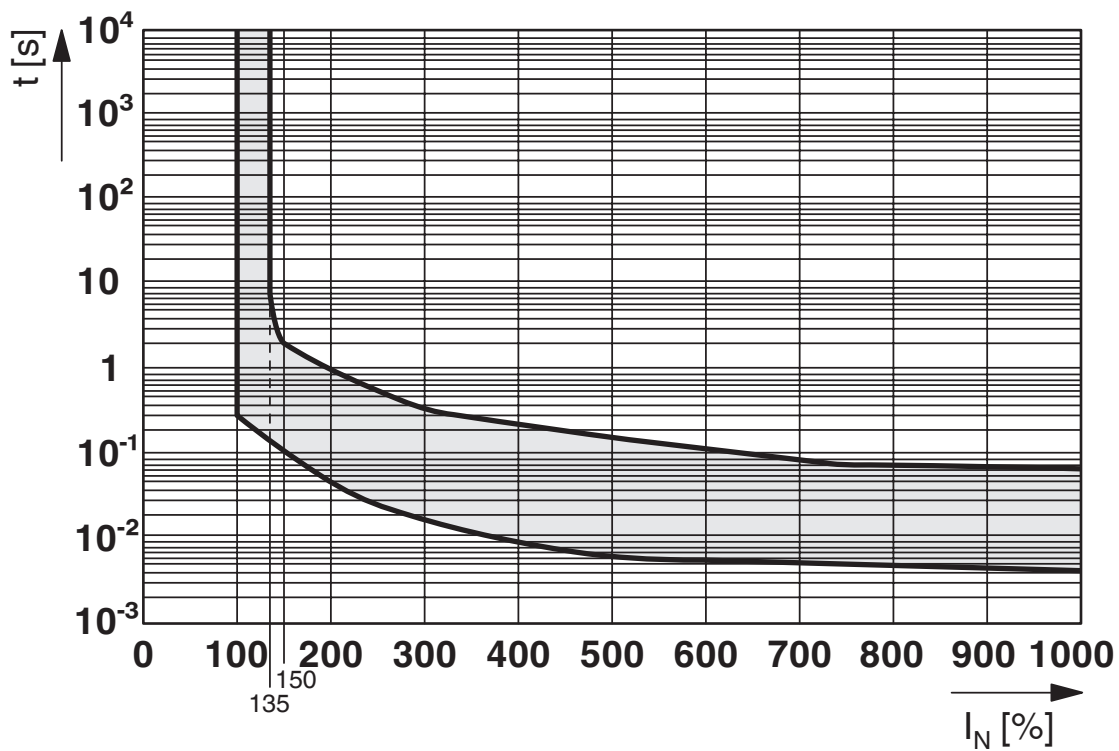

# HMC 11 120AC 5A C1D2 TBUS - Hydraulic-magnetic circuit breaker



2907203

<https://www.phoenixcontact.com/us/products/2907203>

## Approvals

To download certificates, visit the product detail page: <https://www.phoenixcontact.com/us/products/2907203>



**cUL Recognized**  
Approval ID: FILE E 140459



**UL Recognized**  
Approval ID: FILE E 140459



**cUL Recognized**  
Approval ID: FILE E 360692



**UL Recognized**  
Approval ID: FILE E 360692

# HMC 11 120AC 5A C1D2 TBUS - Hydraulic-magnetic circuit breaker



2907203

<https://www.phoenixcontact.com/us/products/2907203>

## Classifications

### ECLASS

ECLASS-13.0	27140401
ECLASS-15.0	27140401

# HMC 11 120AC 5A C1D2 TBUS - Hydraulic-magnetic circuit breaker



2907203

<https://www.phoenixcontact.com/us/products/2907203>

## Environmental product compliance

### EU RoHS

Fulfills EU RoHS substance requirements	Not applicable, Not qualified for the European market
---	---

### China RoHS

Environment friendly use period (EFUP)	EFUP-50
	An article-related China RoHS declaration table can be found in the download area for the respective article under "Manufacturer declaration". For all articles with EFUP-E, no China RoHS declaration table issued and required.

### EU REACH SVHC

REACH candidate substance (CAS No.)	No substance above 0.1 wt%
-------------------------------------	----------------------------

Phoenix Contact 2026 © - all rights reserved  
<https://www.phoenixcontact.com>

Phoenix Contact USA  
586 Fulling Mill Road  
Middletown, PA 17057, United States  
(+717) 944-1300  
[info@phoenixcon.com](mailto:info@phoenixcon.com)