

VIP-CAB-FLK14/16/6,0M/S7 - Cable



2904522

<https://www.phoenixcontact.com/us/products/2904522>

Please be informed that the data shown in this PDF document is generated from our online catalog. Please find the complete data in the user documentation. Our general terms of use for downloads are valid.

Round cable set; controller: SIMATIC® TOP connect; connection 1: IDC/FLK socket strip (1x 16-position); connection 2: IDC/FLK socket strip (1x 14-position); cable length: 6 m



Commercial data

Item number	2904522
Packing unit	1 pc
Note	Made to order (non-returnable)
Sales key	C02
Product key	DK2221
GTIN	4046356859349
Weight per piece (including packing)	333.33 g
Weight per piece (excluding packing)	333.33 g
Customs tariff number	85444290
Country of origin	DE

VIP-CAB-FLK14/16/6,0M/S7 - Cable



2904522

<https://www.phoenixcontact.com/us/products/2904522>

Technical data

Product properties

Product type	System cable
--------------	--------------

Environmental and real-life conditions

Ambient conditions

Ambient temperature (operation)	-20 °C ... 50 °C
Ambient temperature (storage/transport)	-20 °C ... 70 °C

Electrical properties

Operating voltage (AC)	≤ 50 V AC
Operating voltage (DC)	≤ 60 V DC
Current (Per path)	≤ 1 A

Cable/line

Cable length	6 m
--------------	-----

14X0.14 [PVC]

UL AWM Style	2464/1061
Number of positions	14
Shielded	no
Cable type	14X0.14 [PVC]
Conductor type	Round cable set
Conductor structure signal line	7x 0.16 mm
AWG signal line	26
Conductor cross-section	14x 0.14 mm ²
Wire diameter incl. insulation	1 mm ±0.03 mm
External cable diameter	6.40 mm ±0.4 mm
Outer sheath, material	Semi-rigid PVC
External sheath, color	gray
Conductor material	Tin-plated Cu litz wires
Cable resistance	≤ 145 Ω/km (20 °C)
Insulation resistance	≥ 20 MΩ*km (20 °C)
Smallest bending radius, fixed installation	55 mm
Smallest bending radius, movable installation	104 mm
Dynamic load capacity (bending)	Max. bending cycles: 5000 (at a radius of ≥ 15x outside diameter)
Halogen-free	no
Flame resistance	IEC 60332-1-2 (raw cable) VDE 0842, Part 332-1-2 (raw cable) IEC 60332-3-22 (raw cable) UL VW-1 CSA FT-1

VIP-CAB-FLK14/16/6,0M/S7 - Cable



2904522

<https://www.phoenixcontact.com/us/products/2904522>

Resistance to oil	can withstand occasional splashes (raw cable)
Cable type	Cable for one module

Connection data

Field level

Connection method	IDC/FLK socket strip
Number of connections	1
Number of positions	14
Pitch	2.54 mm

Controller level

Connection method	IDC/FLK socket strip
Number of connections	1
Number of positions	16
Pitch	2.54 mm

Notes

Notes on operation	For proper use, the specifications of the installation directive (see Downloads) must be observed. For applications or use with third-party products, the specifications, and the safety and warning instructions of the respective third-party manufacturer must also be met.
--------------------	--

VIP-CAB-FLK14/16/6,0M/S7 - Cable

2904522

<https://www.phoenixcontact.com/us/products/2904522>



Drawings

Dimensional drawing

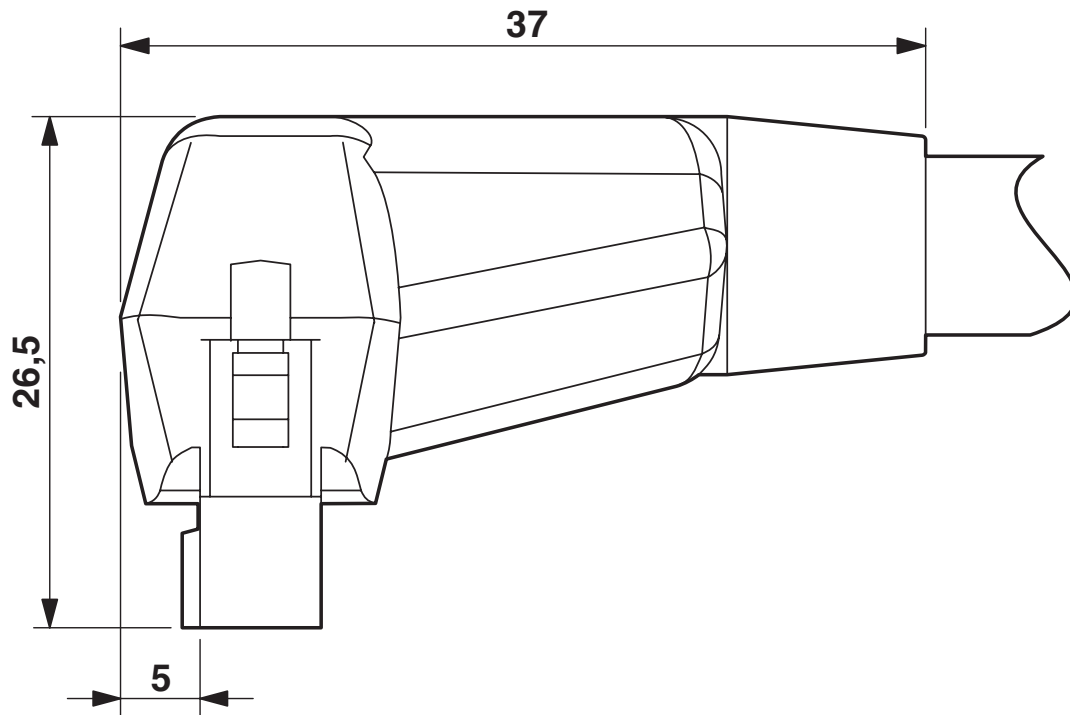

VIP-CAB-FLK14/16/6,0M/S7 - Cable



2904522

<https://www.phoenixcontact.com/us/products/2904522>

Connection diagram

14-pos. Socket strip PIN	16-pos. Socket strip PIN	Wire color
1	16	Black
2	14	Brown
3	12	Red
4	10	Orange
5	8	Yellow
6	6	Green
7	4	Blue
8	2	Violet
9	9	Gray
10	1	White
11	11	White-black
12	3	White-brown
13	13	White-red
14	5	White-orange
	7	-
	15	-

Pin assignment and color code

2904522

<https://www.phoenixcontact.com/us/products/2904522>

Environmental product compliance

China RoHS

Environment friendly use period (EFUP)	EFUP-50
	An article-related China RoHS declaration table can be found in the download area for the respective article under "Manufacturer declaration". For all articles with EFUP-E, no China RoHS declaration table issued and required.

EU REACH SVHC

REACH candidate substance (CAS No.)	No substance above 0.1 wt%
-------------------------------------	----------------------------

Phoenix Contact 2026 © - all rights reserved
<https://www.phoenixcontact.com>

Phoenix Contact USA
586 Fulling Mill Road
Middletown, PA 17057, United States
(+717) 944-1300
info@phoenixcon.com