

RIF-2-RSC-LDP-24DC/4X21 - Relay module



2903320

<https://www.phoenixcontact.com/us/products/2903320>

Please be informed that the data shown in this PDF document is generated from our online catalog. Please find the complete data in the user documentation. Our general terms of use for downloads are valid.



Preassembled relay module with screw connection, consisting of: relay base, power contact relay, and retaining bracket. Contact switching type: 4 changeover contacts. Input voltage: 24 V DC

Product description

The pluggable electromechanical and solid-state relays in the RIFLINE complete product range and the base are recognized and approved in accordance with UL 508. The relevant approvals can be called up at the individual components in question.

Commercial data

Item number	2903320
Packing unit	10 pc
Minimum order quantity	10 pc
Sales key	C465
Product key	DK651A
GTIN	4046356732482
Weight per piece (including packing)	117.95 g
Weight per piece (excluding packing)	115 g
Customs tariff number	85364190
Country of origin	CN

RIF-2-RSC-LDP-24DC/4X21 - Relay module



2903320

<https://www.phoenixcontact.com/us/products/2903320>

Set consists of

RIF-2-BSC/4X21 - Relay base

2900932

<https://www.phoenixcontact.com/us/products/2900932>



RIF-2... relay base, for industrial relay with 2 or 4 changeover contacts, screw connection, plug-in option for input/interference suppression modules, for mounting on NS 35/7,5

RIF-RH-2 - Retaining bracket

2900954

<https://www.phoenixcontact.com/us/products/2900954>



Relay retaining bracket, with ejector function and holder for marking material, suitable for RIF-2 relay base, for industrial relay

RIF-2-RSC-LDP-24DC/4X21 - Relay module



2903320

<https://www.phoenixcontact.com/us/products/2903320>

Technical data

Product properties

Product type	Relay Module
Product family	RIFLINE complete
Application	Universal
Operating mode	100% operating factor
Mechanical service life	approx. 2×10^7 cycles

Insulation characteristics

Insulation	Basic insulation
Overvoltage category	II
Pollution degree	2

Data management status

Date of last data management	01.04.2026
------------------------------	------------

Electrical properties

Maximum power dissipation for nominal condition	1.01 W
Test voltage (Winding/contact)	2.5 kV _{rms} (50 Hz, 1 min., winding/contact)
Test voltage (Changeover contact/changeover contact)	2 kV _{rms} (50 Hz, 1 min., changeover contact/changeover contact)
Rated insulation voltage	250 V AC
Rated surge voltage	2.5 kV

Input data

Coil side

Nominal input voltage U_N	24 V DC
Input voltage range	19.2 V DC ... 30 V DC (20 °C)
Input voltage range in reference to U_N	see diagram
Drive and function	monostable
Drive (polarity)	polarized
Typical input current at U_N	42 mA
Typical response time	13 ms
Typical release time	14 ms
Coil voltage	24 V DC
Protective circuit	Freewheeling diode
Operating voltage display	Yellow LED

Output data

Switching

Contact switching type	4 changeover contacts
Type of switch contact	Single contact
Contact material	AgNi

RIF-2-RSC-LDP-24DC/4X21 - Relay module



2903320

<https://www.phoenixcontact.com/us/products/2903320>

Maximum switching voltage	250 V AC/DC
Minimum switching voltage	5 V (24 mA)
Limiting continuous current	6 A (see diagram)
Maximum inrush current	16 A (20 ms, N/O contacts)
Min. switching current	5 mA (24 V)
Interrupting rating (ohmic load) max.	144 W (24 V DC)
	124 W (48 V DC)
	108 W (60 V DC)
	52 W (110 V DC)
	48 W (220 V DC)
	1500 VA (250 V AC)
Utilization category CB Scheme (IEC 60947-5-1)	AC15, 1 A/240 V (N/O contact)
	DC13, 2 A/24 V (N/O contact)

Connection data

Connection method	Screw connection
Stripping length	8 mm
Conductor cross-section rigid	0.5 mm ² ... 4 mm ²
Conductor cross-section rigid (2 conductors with same cross section)	0.5 mm ² ... 2.5 mm ²
Conductor cross-section flexible	0.5 mm ² ... 4 mm ²
	0.5 mm ² ... 4 mm ² (Ferrule with plastic sleeve)
Conductor cross-section flexible (2 conductors with same cross section)	0.5 mm ² ... 2.5 mm ²
	0.5 mm ² ... 1.5 mm ² (TWIN ferrule with plastic sleeve)
Conductor cross-section AWG	20 ... 10 (solid)
	20 ... 12 (flexible)
Tightening torque	0.5 Nm ... 0.6 Nm

Dimensions

Item dimensions

Width	27 mm
Height	89 mm
Depth	75 mm

Material specifications

Color	gray (RAL 7042)
Flammability rating according to UL 94 (Housing)	V2 (Housing)

Environmental and real-life conditions

Ambient conditions

Degree of protection (Relay base)	IP20 (Relay base)
Degree of protection (Relay)	RT I (Relay)
Ambient temperature (operation)	-40 °C ... 60 °C
Ambient temperature (storage/transport)	-40 °C ... 85 °C

RIF-2-RSC-LDP-24DC/4X21 - Relay module



2903320

<https://www.phoenixcontact.com/us/products/2903320>

Approvals

Corrosive gas test

Identification	ISA-S71.04. G3 Harsh Group
	EN 60068-2-60

Standards and regulations

Standards/regulations	IEC 60947-5-1
-----------------------	---------------

Mounting

Mounting type	DIN rail mounting
Assembly note	in rows with zero spacing
Mounting position	any

Drawings

Diagram

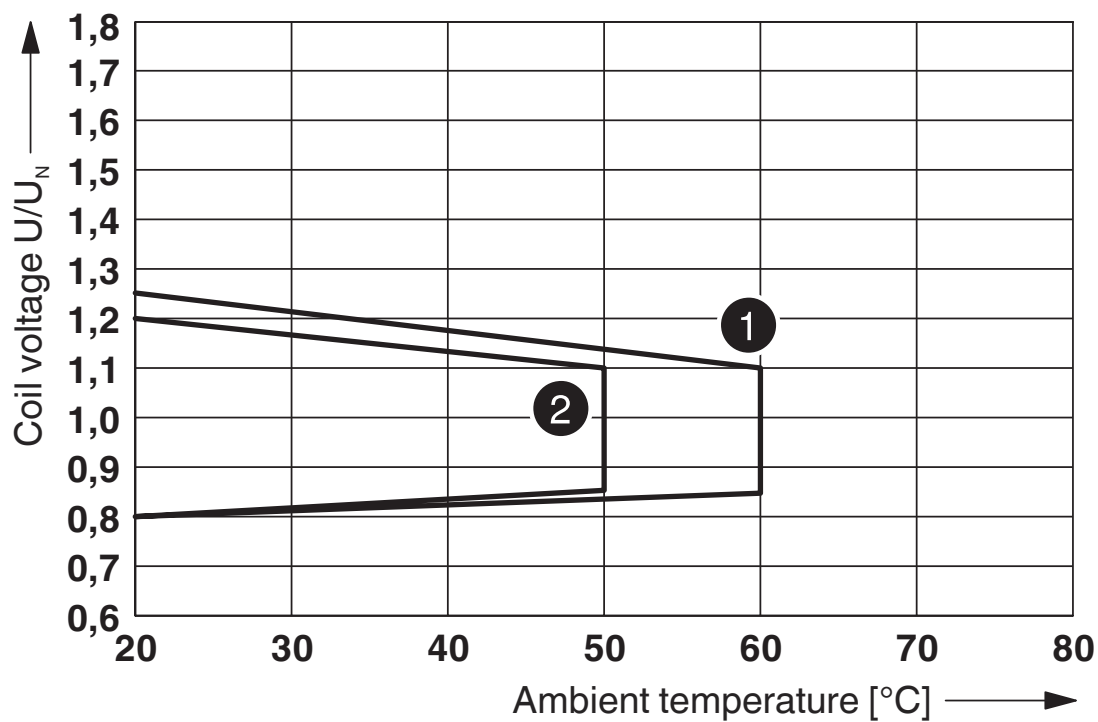

① DC coil (observe contact derating)

② AC coil (observe contact derating)

Operating voltage range

2903320

<https://www.phoenixcontact.com/us/products/2903320>

Diagram

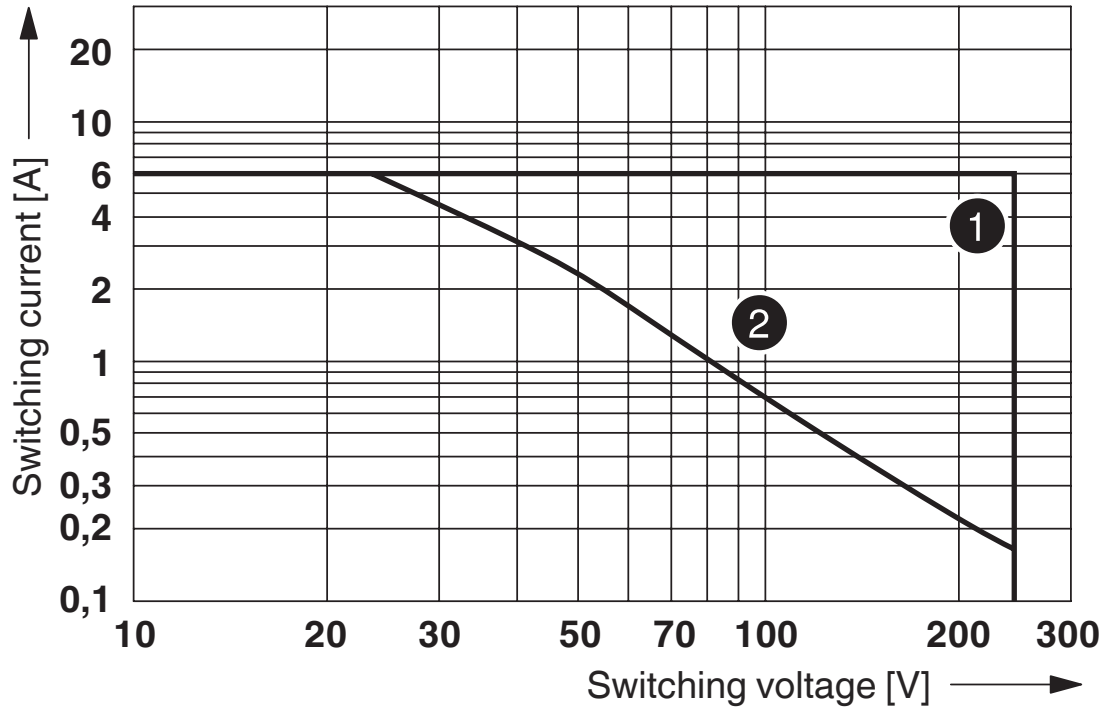

- ① AC, ohmic load
- ② DC, ohmic load

Interrupting rating

Diagram

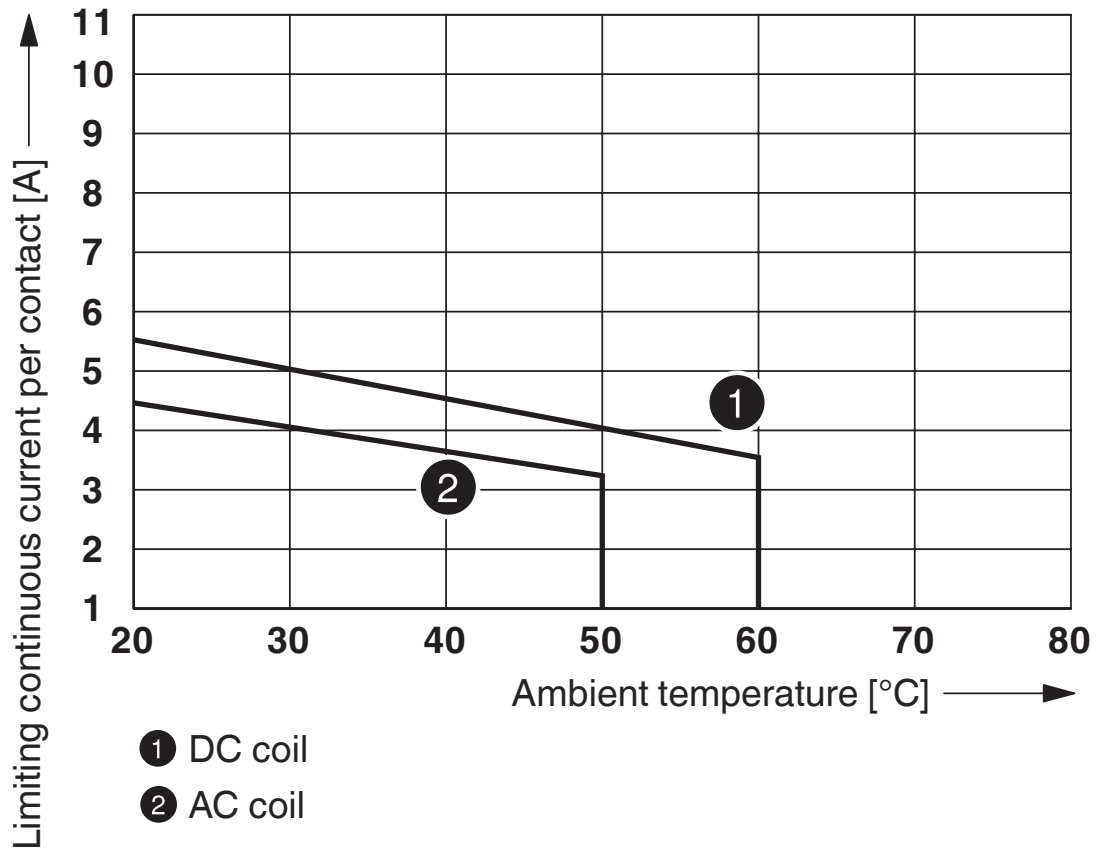

Contact derating

Diagram

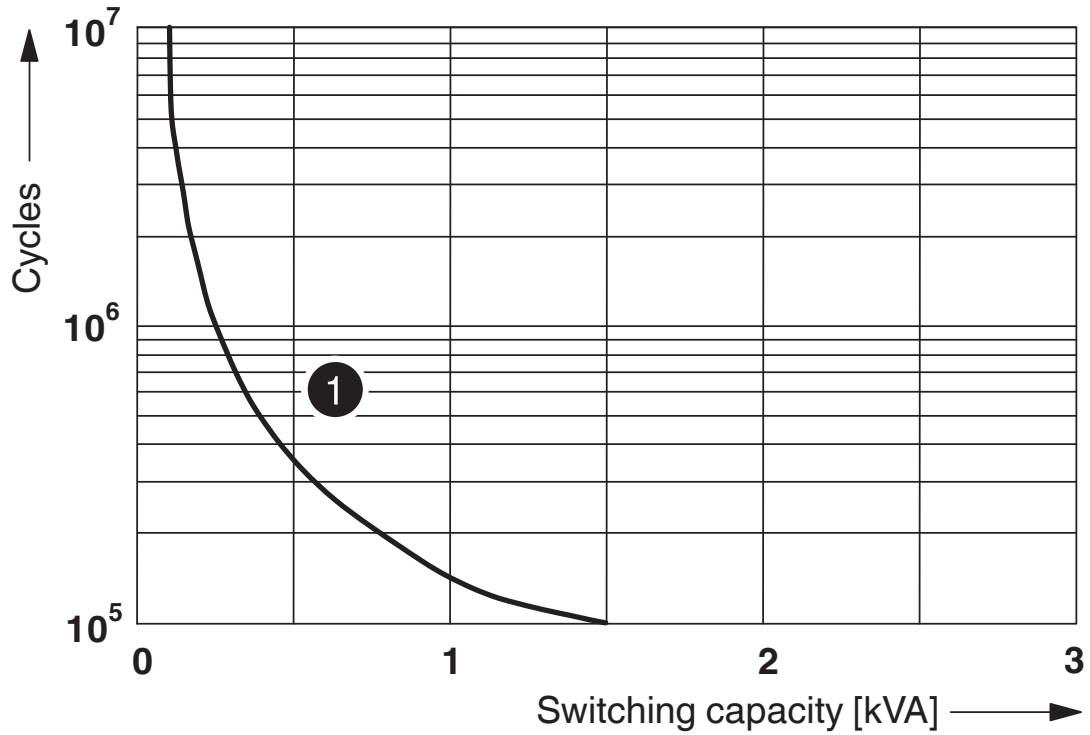

① 250 V AC, Ohmic load

Electrical service life

Diagram

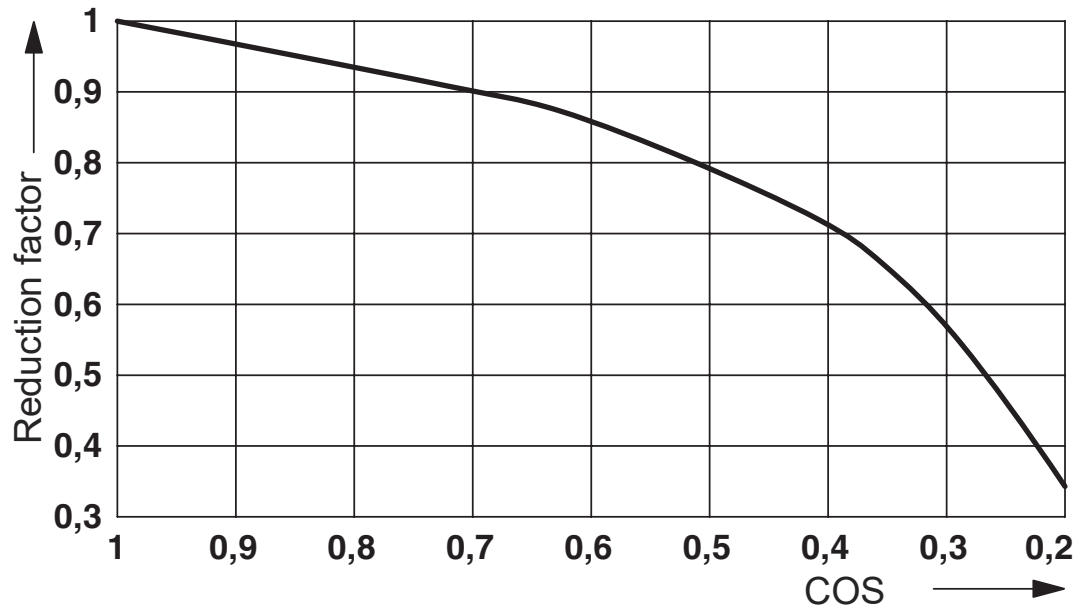

Service life reduction factor

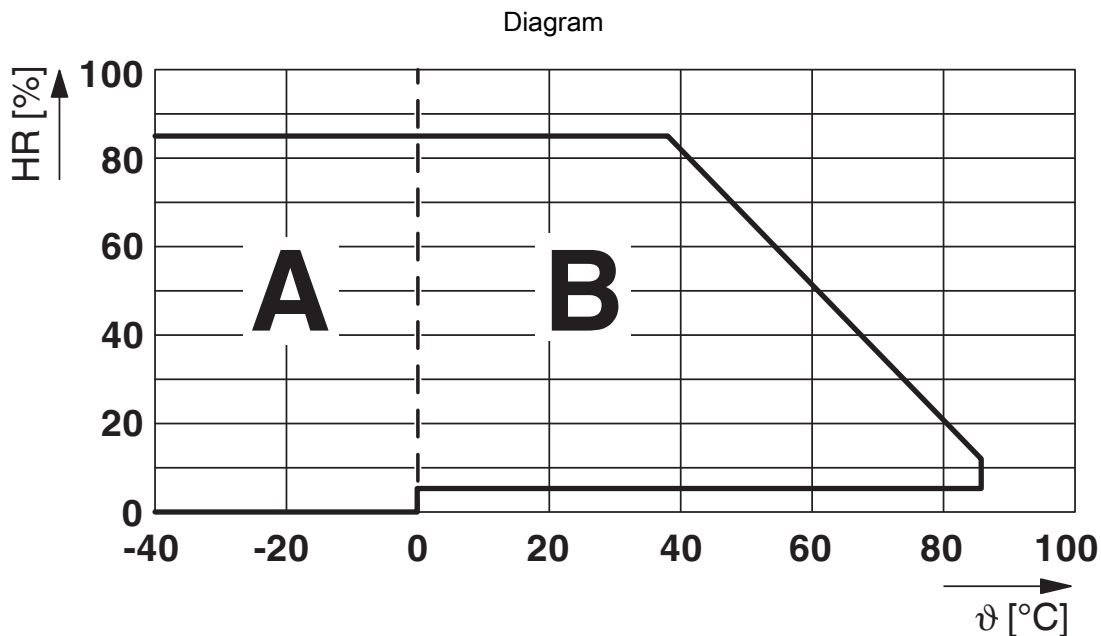

Permissible humidity for operation and storage.

The maximum permissible ambient temperature as specified in the data sheet must be observed.

Area A: Ice buildup at ambient temperatures $\leq 0^\circ\text{C}$ must be prevented

Area B: Condensation at ambient temperatures $> 0^\circ\text{C}$ must be prevented

On 30 full days that are naturally distributed across an entire year, a humidity level of 95% is permissible at an ambient temperature $\leq 25^\circ\text{C}$.

RIF-2-RSC-LDP-24DC/4X21 - Relay module



2903320

<https://www.phoenixcontact.com/us/products/2903320>

Circuit diagram

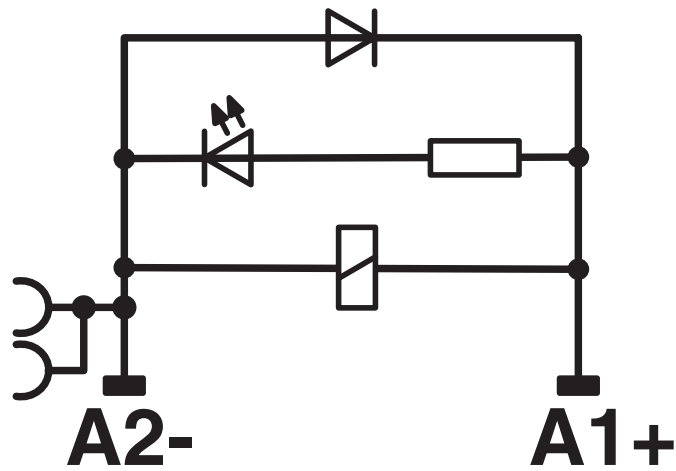
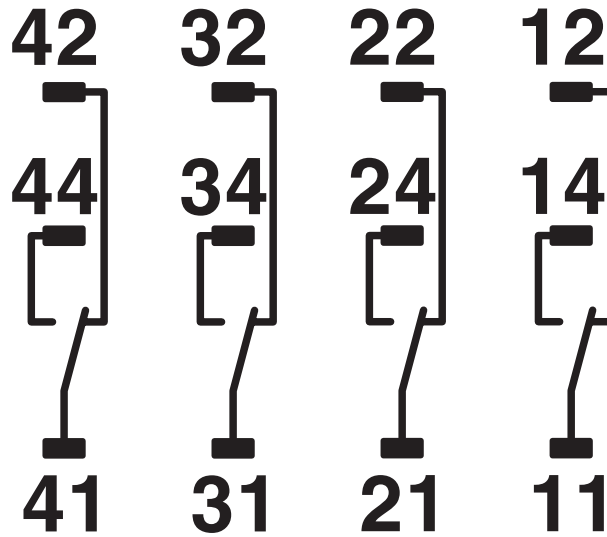

DC coils

RIF-2-RSC-LDP-24DC/4X21 - Relay module



2903320

<https://www.phoenixcontact.com/us/products/2903320>

Classifications

ECLASS

ECLASS-13.0	27371601
ECLASS-15.0	27371601

ETIM

ETIM 9.0	EC001437
----------	----------

UNSPSC

UNSPSC 21.0	39122300
-------------	----------

RIF-2-RSC-LDP-24DC/4X21 - Relay module



2903320

<https://www.phoenixcontact.com/us/products/2903320>

Environmental product compliance

EU RoHS

Fulfills EU RoHS substance requirements	Yes, No exemptions
---	--------------------

China RoHS

Environment friendly use period (EFUP)	EFUP-E
	No hazardous substances above the limits

EU REACH SVHC

REACH candidate substance (CAS No.)	No substance above 0.1 wt%
-------------------------------------	----------------------------

EF3.1 Climate Change

CO2e kg	1.111 kg CO2e
---------	---------------

Phoenix Contact 2026 © - all rights reserved
<https://www.phoenixcontact.com>

Phoenix Contact USA
586 Fulling Mill Road
Middletown, PA 17057, United States
(+717) 944-1300
info@phoenixcon.com