

PLC-OSC- 24DC/ 24DC/100KHZ - Solid-state relay module



2902964

<https://www.phoenixcontact.com/us/products/2902964>

Please be informed that the data shown in this PDF document is generated from our online catalog. Please find the complete data in the user documentation. Our general terms of use for downloads are valid.



Input solid-state relay, transmission frequency: 100 kHz, with LED and protective circuit in input and output circuits, input: 24 V DC, output: 4 ... 30 V DC/50 mA

Commercial data

Item number	2902964
Packing unit	1 pc
Note	Made to order (non-returnable)
Sales key	C461
Product key	DK6215
GTIN	4046356702829
Weight per piece (including packing)	43.3 g
Weight per piece (excluding packing)	33.6 g
Customs tariff number	85364900
Country of origin	DE

PLC-OSC- 24DC/ 24DC/100KHZ - Solid-state relay module



2902964

<https://www.phoenixcontact.com/us/products/2902964>

Technical data

Product properties

Product type	Solid-state relay module
Product family	PLC-INTERFACE
Application	100 kHz input optocoupler
Operating mode	100% operating factor

Insulation characteristics: Air clearances and creepage distances between the power circuits

Insulation	Basic insulation
Overvoltage category	II
Pollution degree	2

Data management status

Date of last data management	15.09.2025
------------------------------	------------

Electrical properties

Maximum power dissipation for nominal condition	0.14 W
Test voltage (Input/output)	2.5 kV _{rms} (50 Hz, 1 min., input/output)

Air clearances and creepage distances between the power circuits

Rated insulation voltage	50 V DC
Rated surge voltage	0.5 kV

Input data

Nominal input voltage U_N	24 V DC
Input voltage range in reference to U_N	0.8 ... 1.2
Input voltage range	19.2 V DC ... 28.8 V DC
Switching threshold "0" signal in reference to U_N	< 0.4
Switching threshold "1" signal in reference to U_N	> 0.8
Typical input current at U_N	6 mA
Typical response time	1.5 μ s
Typical turn-off time	2 μ s
Operating voltage display	Yellow LED
Protective circuit	Reverse polarity protection Surge protection
Surge voltage protection	> 33 V
Transmission frequency	100 kHz

Output data

Designation	Output data
Contact switching type	1 N/O contact
Design of digital output	electronic
Output voltage range	4 V DC ... 30 V DC
Limiting continuous current	50 mA

PLC-OSC- 24DC/ 24DC/100KHZ - Solid-state relay module



2902964

<https://www.phoenixcontact.com/us/products/2902964>

Quiescent current	4.3 mA
Surge voltage protection	> 35 V
Voltage drop at max. limiting continuous current	< 0.5 V
Output circuit	3-conductor, ground-referenced
Protective circuit	Reverse polarity protection Surge protection

Connection data

Connection method	Screw connection
Stripping length	8 mm
Screw thread	M3
Conductor cross-section rigid	0.14 mm ² ... 2.5 mm ²
Conductor cross-section flexible	0.14 mm ² ... 2.5 mm ² 0.2 mm ² ... 2.5 mm ² (Single ferrule) 2x 0.5 mm ² ... 1.5 mm ² (TWIN ferrule)
Conductor cross-section AWG	26 ... 14
Tightening torque	0.6 Nm ... 0.8 Nm

Dimensions

Width	6.2 mm
Height	80 mm
Depth	86 mm

Material specifications

Color	gray (RAL 7042)
-------	-----------------

Environmental and real-life conditions

Ambient conditions

Degree of protection	IP20
Ambient temperature (operation)	-20 °C ... 60 °C
Ambient temperature (storage/transport)	-25 °C ... 75 °C

Approvals

Corrosive gas test

Identification	ISA-S71.04. G3 Harsh Group EN 60068-2-60
----------------	---------------------------------------------

Standards and regulations

Air clearances and creepage distances between the power circuits

Standards/regulations	DIN EN 50178
-----------------------	--------------

Mounting

Mounting type	DIN rail mounting
---------------	-------------------

PLC-OSC- 24DC/ 24DC/100KHZ - Solid-state relay module



2902964

<https://www.phoenixcontact.com/us/products/2902964>

Assembly note	in rows with zero spacing
Mounting position	any

PLC-OSC- 24DC/ 24DC/100KHZ - Solid-state relay module



2902964

<https://www.phoenixcontact.com/us/products/2902964>

Drawings

Circuit diagram

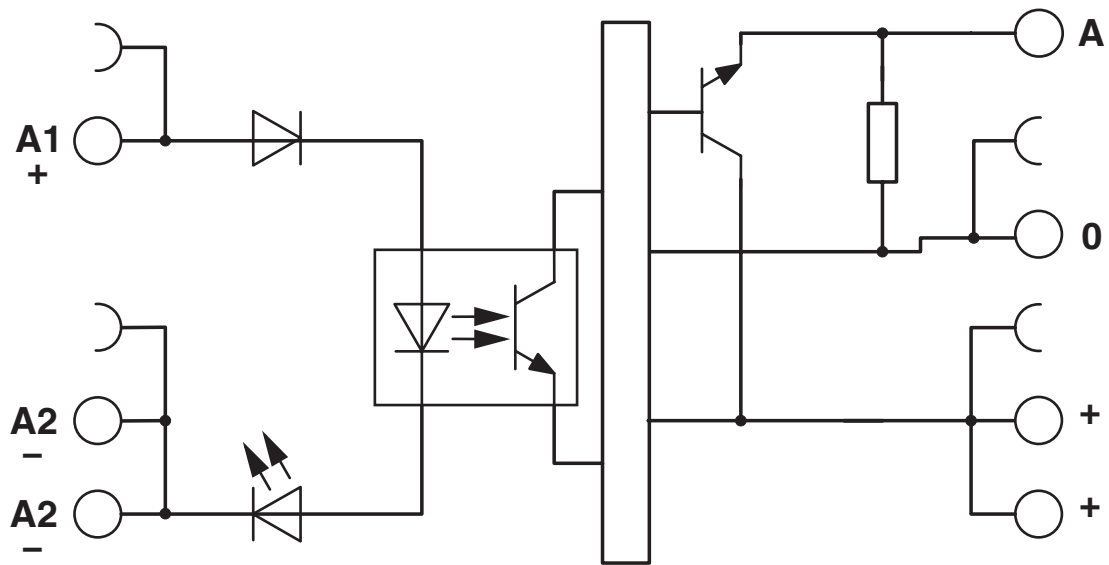

PLC-OSC- 24DC/ 24DC/100KHZ - Solid-state relay module



2902964

<https://www.phoenixcontact.com/us/products/2902964>

Classifications

UNSPSC

UNSPSC 21.0	39122300
-------------	----------

PLC-OSC- 24DC/ 24DC/100KHZ - Solid-state relay module



2902964

<https://www.phoenixcontact.com/us/products/2902964>

Environmental product compliance

EU RoHS

Fulfills EU RoHS substance requirements	Yes
Exemption	7(a), 7(c)-I

China RoHS

Environment friendly use period (EFUP)	EFUP-50
	An article-related China RoHS declaration table can be found in the download area for the respective article under "Manufacturer declaration". For all articles with EFUP-E, no China RoHS declaration table issued and required.

EU REACH SVHC

REACH candidate substance (CAS No.)	Lead(CAS: 7439-92-1)
-------------------------------------	----------------------

Phoenix Contact 2026 © - all rights reserved
<https://www.phoenixcontact.com>

Phoenix Contact USA
586 Fulling Mill Road
Middletown, PA 17057, United States
(+717) 944-1300
info@phoenixcon.com