

# PT 1,5/ 2-PVH-3,5-A - PCB connector

1984167

<https://www.phoenixcontact.com/us/products/1984167>

Please be informed that the data shown in this PDF document is generated from our online catalog. Please find the complete data in the user documentation. Our general terms of use for downloads are valid.



PCB connector, nominal cross section: 1.5 mm<sup>2</sup>, color: green, nominal current: 8 A, rated voltage (III/2): 200 V, contact surface: Sn, contact connection type: Socket, number of potentials: 2, number of rows: 1, number of positions: 2, number of connections: 2, product range: PT 1,5/-PVH-A, pitch: 3.5 mm, connection method: Screw connection with wire protector, screw head form: H1L Slotted Phillips recess, conductor/PCB connection direction: 0 °, plug-in system: COMBICON PST 1,0, locking: without, mounting method: without, type of packaging: packed in cardboard

## Your advantages

- Well-known connection principle allows worldwide use
- Low temperature rise, thanks to maximum contact force
- High terminal block capacity thanks to rectangular terminal block space
- Allows connection of two conductors
- Horizontal and vertical connection option for optimum conductor routing
- Items that can be aligned in various pitches support flexible and space-saving PCB assembly

## Commercial data

Item number	1984167
Packing unit	250 pc
Minimum order quantity	250 pc
Note	Made to order (non-returnable)
Sales key	AA02
Product key	AABAID
GTIN	4046356035996
Weight per piece (including packing)	1.47 g
Weight per piece (excluding packing)	1.33 g
Customs tariff number	85366990
Country of origin	CN

# PT 1,5/ 2-PVH-3,5-A - PCB connector



1984167

<https://www.phoenixcontact.com/us/products/1984167>

## Technical data

### Product properties

Product type	PCB connector
Product family	PT 1,5/...-PVH-A
Product line	COMBICON Connectors S
Type	PC termination block
Number of positions	2
Pitch	3.5 mm
Number of connections	2
Number of rows	1
Number of potentials	2
Mounting type	without

### Electrical properties

#### Properties

Nominal current $I_N$	8 A
Nominal voltage $U_N$	200 V
Contact resistance	1.6 mΩ
Rated voltage (III/3)	160 V
Rated surge voltage (III/3)	2.5 kV
Rated voltage (III/2)	200 V
Rated surge voltage (III/2)	2.5 kV
Rated voltage (II/2)	400 V
Rated surge voltage (II/2)	2.5 kV

### Connection data

#### Connection technology

Type	PC termination block
Connector system	COMBICON PST 1,0
Nominal cross section	1.5 mm <sup>2</sup>
Contact connection type	Socket

#### Interlock

Locking type	without
Mounting type	without

#### Conductor connection

Connection method	Screw connection with wire protector
Conductor/PCB connection direction	0 °
Conductor cross-section rigid	0.2 mm <sup>2</sup> ... 1.5 mm <sup>2</sup>
Conductor cross-section flexible	0.2 mm <sup>2</sup> ... 1.5 mm <sup>2</sup>
Conductor cross-section AWG	26 ... 16

# PT 1,5/ 2-PVH-3,5-A - PCB connector

1984167

<https://www.phoenixcontact.com/us/products/1984167>

Conductor cross-section, flexible, with ferrule, with plastic sleeve	0.25 mm <sup>2</sup> ... 0.75 mm <sup>2</sup>
2 conductors with same cross section, rigid	0.2 mm <sup>2</sup> ... 0.34 mm <sup>2</sup>
2 conductors with same cross section, flexible	0.2 mm <sup>2</sup> ... 0.5 mm <sup>2</sup>
Cylindrical gauge a x b / diameter	2.4 mm x 1.5 mm / 1.9 mm
Stripping length	5 mm
Drive form screw head	Slotted Phillips recess (H1L)
Tightening torque	0.22 Nm ... 0.25 Nm

## Material specifications

### Material data - contact

Note	WEEE/RoHS-compliant, free of whiskers according to IEC 60068-2-82/JEDEC JESD 201
Contact material	Cu alloy
Surface characteristics	hot-dip tin-plated
Metal surface terminal point (top layer)	Tin (4 µm - 8 µm Sn)
Metal surface contact area (top layer)	Tin (4 µm - 8 µm Sn)

### Material data - housing

Color (Housing)	green (6021)
Insulating material	PA
Insulating material group	I
CTI according to IEC 60112	600
Flammability rating according to UL 94	V0
Glow wire flammability index GWFI according to EN 60695-2-12	850
Glow wire ignition temperature GWIT according to EN 60695-2-13	775
Temperature for the ball pressure test according to EN 60695-10-2	125 °C

## Dimensions

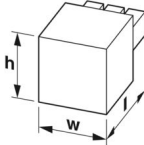
Dimensional drawing	
Pitch	3.5 mm
Width [w]	7 mm
Height [h]	11.1 mm
Length [l]	14.6 mm

## Mechanical tests

### Test for conductor damage and slackening

Specification	IEC 60999-1:1999-11
Result	Test passed

# PT 1,5/ 2-PVH-3,5-A - PCB connector



1984167

<https://www.phoenixcontact.com/us/products/1984167>

## Pull-out test

Specification	IEC 60999-1:1999-11
Conductor cross-section/conductor type/tractive force setpoint/actual value	0.2 mm <sup>2</sup> / solid / > 10 N
	0.2 mm <sup>2</sup> / flexible / > 10 N
	1.5 mm <sup>2</sup> / solid / > 40 N
	1.5 mm <sup>2</sup> / flexible / > 40 N

## Insertion and withdrawal forces

Specification	IEC 60512-7:1993-08
Result	Test passed
No. of cycles	10
Insertion strength per pos. approx.	4 N
Withdraw strength per pos. approx.	4 N

## Torque test

Specification	IEC 60999-1:1999-11
---------------	---------------------

## Resistance of inscriptions

Specification	IEC 60068-2-70:1995-12
Result	Test passed

## Polarization and coding

Specification	IEC 60512-7:1993-08 (Polarization)
Result	Test passed

## Visual inspection

Specification	IEC 60512-1-1:2002-02
Result	Test passed

## Dimension check

Specification	IEC 60512-1-2:2002-02
Result	Test passed

## Environmental and real-life conditions

### Durability test

Specification	IEC 60512-5:1992-08
Impulse withstand voltage at sea level	2.5 kV
Contact resistance R <sub>1</sub>	1.6 mΩ
Contact resistance R <sub>2</sub>	1.7 mΩ
Insertion/withdrawal cycles	10

### Climatic test

Specification	ISO 6988:1985-02
Corrosive stress	0.2 dm <sup>3</sup> SO <sub>2</sub> on 300 dm <sup>3</sup> /40 °C/1 cycle
Thermal stress	100 °C/168 h
Power-frequency withstand voltage	2 kV

# PT 1,5/ 2-PVH-3,5-A - PCB connector



1984167

<https://www.phoenixcontact.com/us/products/1984167>

## Vibration test

Specification	IEC 60068-2-6:1995-03
Frequency	10 - 150 - 10 Hz
Sweep speed	1 octave/min
Amplitude	0.35 mm (10 Hz ... 60.1 Hz)
Acceleration	5g (60.1 Hz ... 150 Hz)
Test duration per axis	2.5 h
Test directions	X-, Y- and Z-axis

## Ambient conditions

Ambient temperature (storage/transport)	-40 °C ... 70 °C
Relative humidity (storage/transport)	30 % ... 70 %
Ambient temperature (assembly)	-5 °C ... 100 °C
Ambient temperature (operation)	-40 °C ... 100 °C (dependent on the derating curve)

## Electrical tests

### Thermal test | Test group C

Specification	IEC 60512-5-1:2002-02
Tested number of positions	16

### Insulation resistance

Specification	IEC 60512-3-1:2002-02
Insulation resistance, neighboring positions	$10^{12} \Omega$

### Air clearances and creepage distances |

Specification	IEC 60664-1:2007-04
Insulating material group	I
Comparative tracking index (IEC 60112)	CTI 600
Rated insulation voltage (III/3)	160 V
Rated surge voltage (III/3)	2.5 kV
minimum clearance value - non-homogenous field (III/3)	1.5 mm
minimum creepage distance (III/3)	2 mm
Rated insulation voltage (III/2)	200 V
Rated surge voltage (III/2)	2.5 kV
minimum clearance value - non-homogenous field (III/2)	1.5 mm
minimum creepage distance (III/2)	1 mm
Rated insulation voltage (II/2)	400 V
Rated surge voltage (II/2)	2.5 kV
minimum clearance value - non-homogenous field (II/2)	1.5 mm
minimum creepage distance (II/2)	2 mm

## Packaging specifications

Type of packaging	packed in cardboard
-------------------	---------------------

# PT 1,5/ 2-PVH-3,5-A - PCB connector

1984167

<https://www.phoenixcontact.com/us/products/1984167>

## Drawings

Diagram



Type: PT 1,5/...-PVH-3,5 with PST 1,0/...-3,5

# PT 1,5/ 2-PVH-3,5-A - PCB connector



1984167

<https://www.phoenixcontact.com/us/products/1984167>

## Approvals

To download certificates, visit the product detail page: <https://www.phoenixcontact.com/us/products/1984167>

 <b>cULus Recognized</b> Approval ID: E60425-20030211				
	Nominal voltage $U_N$	Nominal current $I_N$	Cross section AWG	Cross section $\text{mm}^2$
B	300 V	10 A	26 - 16	-
D	300 V	10 A	26 - 16	-

 <b>VDE Gutachten mit Fertigungsüberwachung</b> Approval ID: 40040542				
	Nominal voltage $U_N$	Nominal current $I_N$	Cross section AWG	Cross section $\text{mm}^2$
keine	320 V	8 A	-	0.2 - 1.5

# PT 1,5/ 2-PVH-3,5-A - PCB connector



1984167

<https://www.phoenixcontact.com/us/products/1984167>

## Classifications

### ECLASS

ECLASS-13.0	27460202
ECLASS-15.0	27460202

### ETIM

ETIM 10.0	EC002638
-----------	----------

### UNSPSC

UNSPSC 21.0	39121400
-------------	----------

# PT 1,5/ 2-PVH-3,5-A - PCB connector



1984167

<https://www.phoenixcontact.com/us/products/1984167>

## Environmental product compliance

### EU RoHS

Fulfills EU RoHS substance requirements	Yes
Exemption	6(c)

### China RoHS

Environment friendly use period (EFUP)	EFUP-50
	An article-related China RoHS declaration table can be found in the download area for the respective article under "Manufacturer declaration". For all articles with EFUP-E, no China RoHS declaration table issued and required.

### EU REACH SVHC

REACH candidate substance (CAS No.)	Lead(CAS: 7439-92-1)
SCIP	a7d4f392-f50c-4fe9-8e4e-75e6ffcd2bd7

### EF3.1 Climate Change

CO2e kg	0.025 kg CO2e
---------	---------------

Phoenix Contact 2026 © - all rights reserved  
<https://www.phoenixcontact.com>

Phoenix Contact USA  
586 Fulling Mill Road  
Middletown, PA 17057, United States  
(+717) 944-1300  
[info@phoenixcon.com](mailto:info@phoenixcon.com)