

TFKC 2,5/ 3-ST-5,08 - PCB connector

1962613

<https://www.phoenixcontact.com/us/products/1962613>

Please be informed that the data shown in this PDF document is generated from our online catalog. Please find the complete data in the user documentation. Our general terms of use for downloads are valid.

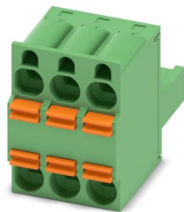

PCB TWIN plug, nominal cross section: 2.5 mm², color: green, nominal current: 12 A, rated voltage (III/2): 320 V, contact surface: Sn, contact connection type: Socket, number of potentials: 3, number of rows: 1, number of positions: 3, number of connections: 6, product range: TFKC 2,5/..-ST, pitch: 5.08 mm, connection method: Push-in spring connection, conductor/PCB connection direction: 0 °, locking clip: - Locking clip, plug-in system: COMBICON MSTB 2,5, locking: without, mounting method: without, type of packaging: packed in cardboard

Your advantages

- Time saving push-in connection, tools not required
- Potentials can be easily looped through – ideal for BUS applications
- Intuitive operation due to color-coded actuating push button
- Can be combined with the MSTB 2,5 range
- Quick and convenient testing using integrated test option

Commercial data

Item number	1962613
Packing unit	50 pc
Minimum order quantity	50 pc
Sales key	AA03
Product key	AACFMA
GTIN	4017918912048
Weight per piece (including packing)	6.827 g
Weight per piece (excluding packing)	6.827 g
Customs tariff number	85366990
Country of origin	BG

TFKC 2,5/ 3-ST-5,08 - PCB connector



1962613

<https://www.phoenixcontact.com/us/products/1962613>

Technical data

Product properties

Product type	PCB TWIN plug
Product family	TFKC 2,5/..-ST
Product line	COMBICON Connectors M
Type	Bus plug component
Number of positions	3
Pitch	5.08 mm
Number of connections	6
Number of rows	1
Number of potentials	3
Mounting type	without

Electrical properties

Properties

Nominal current I_N	12 A
Nominal voltage U_N	320 V
Contact resistance	2 m Ω
Rated voltage (III/3)	320 V
Rated surge voltage (III/3)	4 kV
Rated voltage (III/2)	320 V
Rated surge voltage (III/2)	4 kV
Rated voltage (II/2)	630 V
Rated surge voltage (II/2)	4 kV

Conductor connection I2 / I3

Current carrying capacity	24 A
---------------------------	------

Plug-in contact I1

Current carrying capacity	12 A
---------------------------	------

Connection data

Connection technology

Type	Bus plug component
Connector system	COMBICON MSTB 2,5
Nominal cross section	2.5 mm ²
Contact connection type	Socket

Interlock

Locking type	without
Mounting type	without

Conductor connection

TFKC 2,5/ 3-ST-5,08 - PCB connector



1962613

<https://www.phoenixcontact.com/us/products/1962613>

Connection method	Push-in spring connection
Conductor/PCB connection direction	0 °
Conductor cross-section rigid	0.2 mm ² ... 2.5 mm ²
Conductor cross-section flexible	0.2 mm ² ... 2.5 mm ²
Conductor cross-section AWG	24 ... 12
Conductor cross-section, flexible, with ferrule, without plastic sleeve	0.25 mm ² ... 2.5 mm ²
Conductor cross-section, flexible, with ferrule, with plastic sleeve	0.25 mm ² ... 2.5 mm ²
2 conductors with the same cross section, flexible, with TWIN ferrule with plastic sleeve	0.5 mm ² ... 1.5 mm ²
Cylindrical gauge a x b / diameter	2.8 mm x 2.0 mm / 2.0 mm
Stripping length	10 mm

Specifications for ferrules without insulating collar

recommended crimping tool	1212034 CRIMPFOX 6
---------------------------	--------------------

Specifications for ferrules with insulating collar

recommended crimping tool	1212034 CRIMPFOX 6
---------------------------	--------------------

Material specifications

Material data - contact

Note	WEEE/RoHS-compliant, free of whiskers according to IEC 60068-2-82/JEDEC JESD 201
Contact material	Cu alloy
Surface characteristics	hot-dip tin-plated
Metal surface terminal point (top layer)	Tin (4 µm - 8 µm Sn)
Metal surface contact area (top layer)	Tin (4 µm - 8 µm Sn)

Material data - housing

Color (Housing)	green (6021)
Insulating material	PA
Insulating material group	I
CTI according to IEC 60112	600
Flammability rating according to UL 94	V0
Glow wire flammability index GWFI according to EN 60695-2-12	850
Glow wire ignition temperature GWIT according to EN 60695-2-13	775
Temperature for the ball pressure test according to EN 60695-10-2	125 °C

Material data – actuating element

Color (Actuating element)	orange (2003)
Insulating material	PBT
Insulating material group	IIIa
CTI according to IEC 60112	275
Flammability rating according to UL 94	V0

TFKC 2,5/ 3-ST-5,08 - PCB connector

1962613

<https://www.phoenixcontact.com/us/products/1962613>

Dimensions

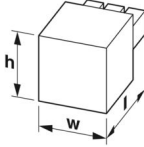
Dimensional drawing	
Pitch	5.08 mm
Width [w]	15.14 mm
Height [h]	22.1 mm
Length [l]	25.7 mm

Notes

Notes on operation	In accordance with IEC 61984, COMBICON connectors have no switching power (COC). During designated use, they must not be plugged in or disconnected when carrying voltage or under load.
--------------------	--

Mechanical tests

Conductor connection

Specification	IEC 60999-1:1999-11
Result	Test passed

Test for conductor damage and slackening

Specification	IEC 60999-1:1999-11
Result	Test passed

Repeated connection and disconnection

Specification	IEC 60999-1:1999-11
Result	Test passed

Pull-out test

Specification	IEC 60999-1:1999-11
Conductor cross-section/conductor type/tractive force setpoint/actual value	0.2 mm ² / solid / > 10 N
	0.2 mm ² / flexible / > 10 N
	2.5 mm ² / solid / > 50 N
	2.5 mm ² / flexible / > 50 N

Insertion and withdrawal forces

Specification	IEC 60512-13-2:2006-02
Result	Test passed
No. of cycles	25
Insertion strength per pos. approx.	10 N
Withdraw strength per pos. approx.	9.5 N

Resistance of inscriptions

Specification	IEC 60068-2-70:1995-12
---------------	------------------------

TFKC 2,5/ 3-ST-5,08 - PCB connector



1962613

<https://www.phoenixcontact.com/us/products/1962613>

Result	Test passed
Polarization and coding	
Specification	IEC 60512-13-5:2006-02
Result	Test passed
Visual inspection	
Specification	IEC 60512-1-1:2002-02
Result	Test passed
Dimension check	
Specification	IEC 60512-1-2:2002-02
Result	Test passed

Environmental and real-life conditions

Durability test

Specification	IEC 60512-9-1:2010-03
Impulse withstand voltage at sea level	4.8 kV
Contact resistance R_1	2 m Ω
Contact resistance R_2	2.2 m Ω
Insertion/withdrawal cycles	25

Climatic test

Specification	ISO 6988:1985-02
Corrosive stress	0.2 dm ³ SO ₂ on 300 dm ³ /40 °C/1 cycle
Thermal stress	100 °C/168 h
Power-frequency withstand voltage	2.21 kV

Vibration test

Specification	IEC 60068-2-6:2007-12
Frequency	10 - 150 - 10 Hz
Sweep speed	1 octave/min
Amplitude	0.35 mm (10 Hz ... 60.1 Hz)
Acceleration	5g (60.1 Hz ... 150 Hz)
Test duration per axis	2.5 h
Test directions	X-, Y- and Z-axis

Ambient conditions

Ambient temperature (storage/transport)	-40 °C ... 70 °C
Relative humidity (storage/transport)	30 % ... 70 %
Ambient temperature (assembly)	-5 °C ... 100 °C
Ambient temperature (operation)	-40 °C ... 100 °C (dependent on the derating curve)

Ambient conditions

Ambient temperature (operation)	-40 °C ... 100 °C (dependent on the derating curve)
Ambient temperature (storage/transport)	-40 °C ... 70 °C
Relative humidity (storage/transport)	30 % ... 70 %

TFKC 2,5/ 3-ST-5,08 - PCB connector



1962613

<https://www.phoenixcontact.com/us/products/1962613>

Ambient temperature (assembly)	-5 °C ... 100 °C
--------------------------------	------------------

Electrical tests

Thermal test | Test group C

Specification	IEC 60512-5-1:2002-02
Tested number of positions	10

Insulation resistance

Specification	IEC 60512-3-1:2002-02
Insulation resistance, neighboring positions	10 ¹² Ω

Temperature cycles

Specification	IEC 60999-1:1999-11
Result	Test passed

Air clearances and creepage distances |

Specification	IEC 60664-1:2007-04
Insulating material group	I
Comparative tracking index (IEC 60112)	CTI 600
Rated insulation voltage (III/3)	320 V
Rated surge voltage (III/3)	4 kV
minimum clearance value - non-homogenous field (III/3)	3 mm
minimum creepage distance (III/3)	4 mm
Rated insulation voltage (III/2)	320 V
Rated surge voltage (III/2)	4 kV
minimum clearance value - non-homogenous field (III/2)	3 mm
minimum creepage distance (III/2)	3 mm
Rated insulation voltage (II/2)	630 V
Rated surge voltage (II/2)	4 kV
minimum clearance value - non-homogenous field (II/2)	3 mm
minimum creepage distance (II/2)	3.2 mm

Packaging specifications

Type of packaging	packed in cardboard
-------------------	---------------------

Drawings

Diagram



Type: TFKC 2,5/...-ST-5,08 with MSTBVA 2,5/...-G-5,08

Diagram



Type: TFKC 2,5/...-ST-5,08 with CC 2,5/...-G-5,08 P...THR

TFKC 2,5/ 3-ST-5,08 - PCB connector



1962613

<https://www.phoenixcontact.com/us/products/1962613>



Type: TFKC 2,5/...-ST-5,08 with CCV 2,5/...-G-5,08 P...THR



Type: TFKC 2,5/...-ST-5,08 with CCVA 2,5/...-G-5,08 P...THR

TFKC 2,5/ 3-ST-5,08 - PCB connector



1962613

<https://www.phoenixcontact.com/us/products/1962613>

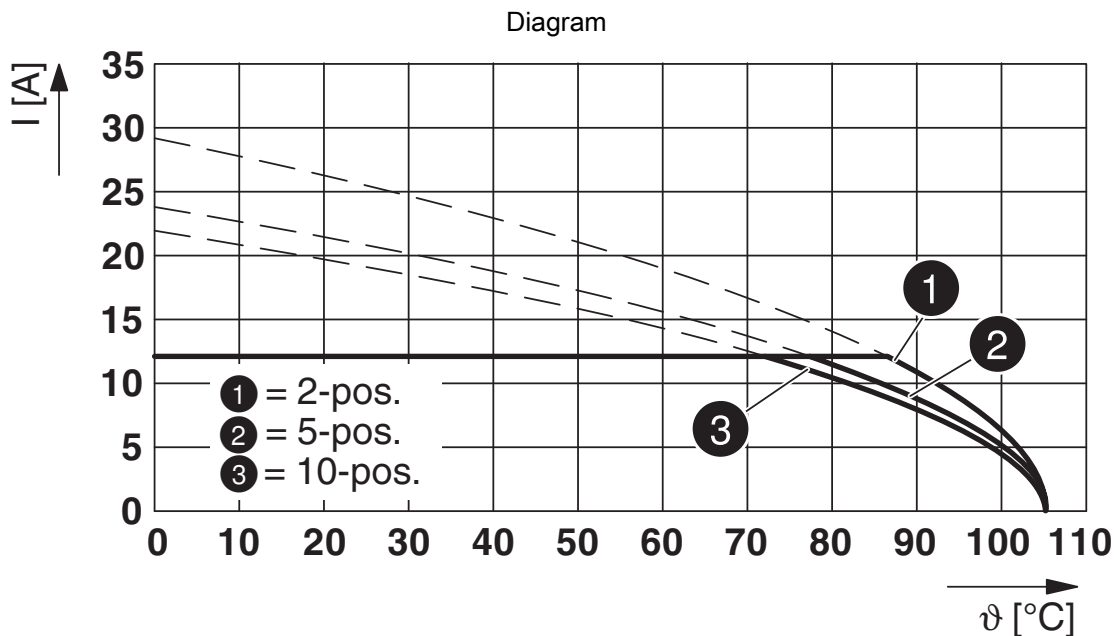

Type: TFKC 2,5/...-ST-5,08 with FKIC 2,5/...-ST-5,08

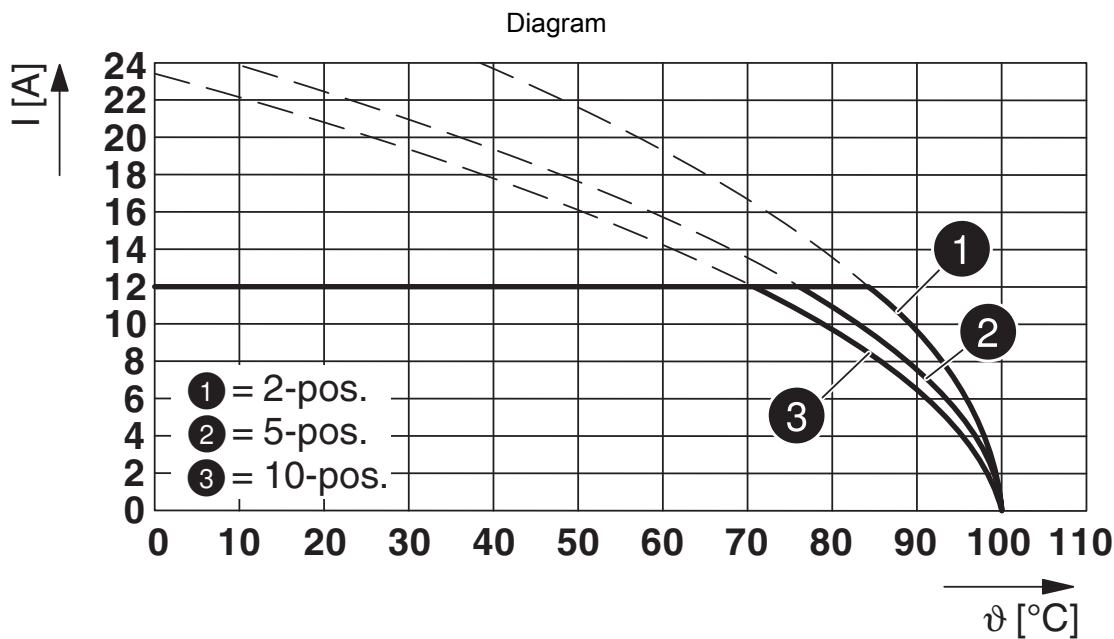

Type: TFKC 2,5/...-ST-5,08 with MSTB 2,5/...-G-5,08

TFKC 2,5/ 3-ST-5,08 - PCB connector



1962613

<https://www.phoenixcontact.com/us/products/1962613>



Type: TFKC 2,5/...-ST-5,08 with CCA 2,5/...-G-5,08 P...THR

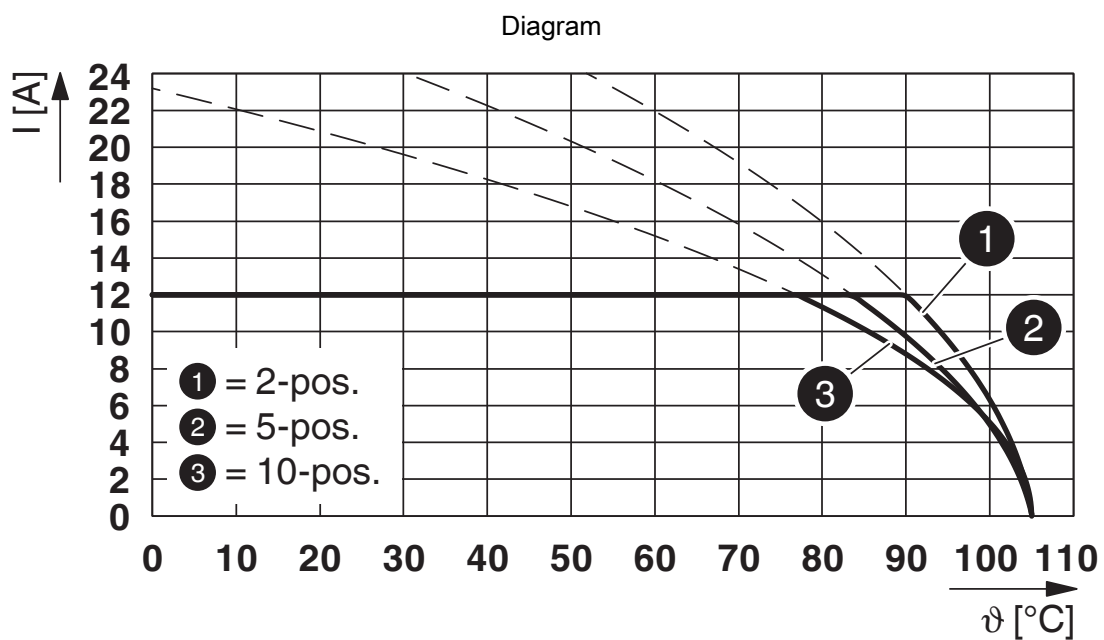

Type: TFKC 2,5/...-ST-5,08 with MSTBA 2,5/...-G-5,08

TFKC 2,5/ 3-ST-5,08 - PCB connector



1962613

<https://www.phoenixcontact.com/us/products/1962613>

Diagram

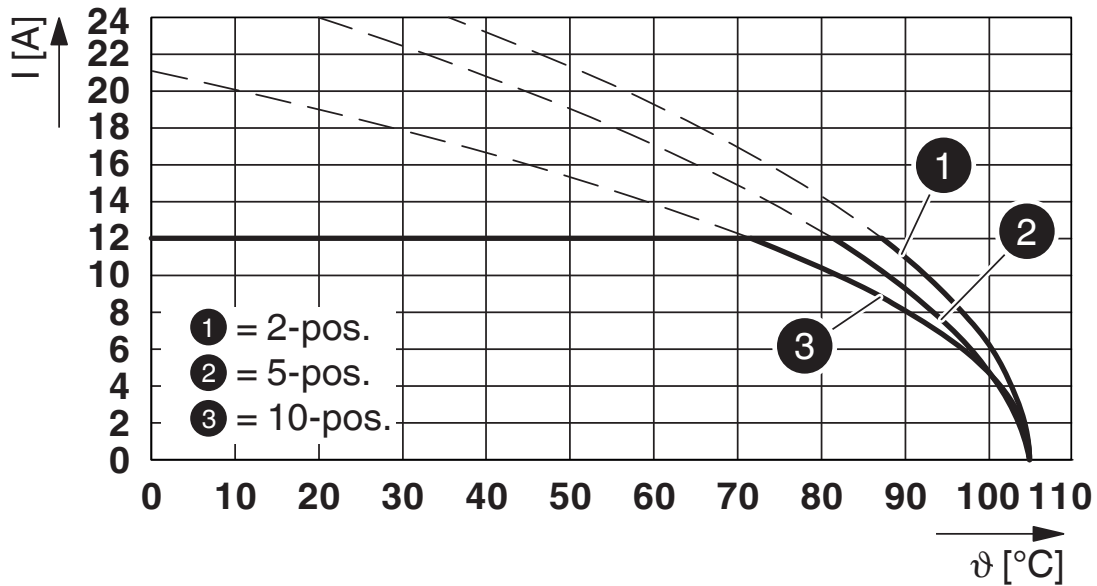

Type: TFKC 2,5/...-ST-5,08 with SMSTBA 2,5/...-G-5,08

Diagram

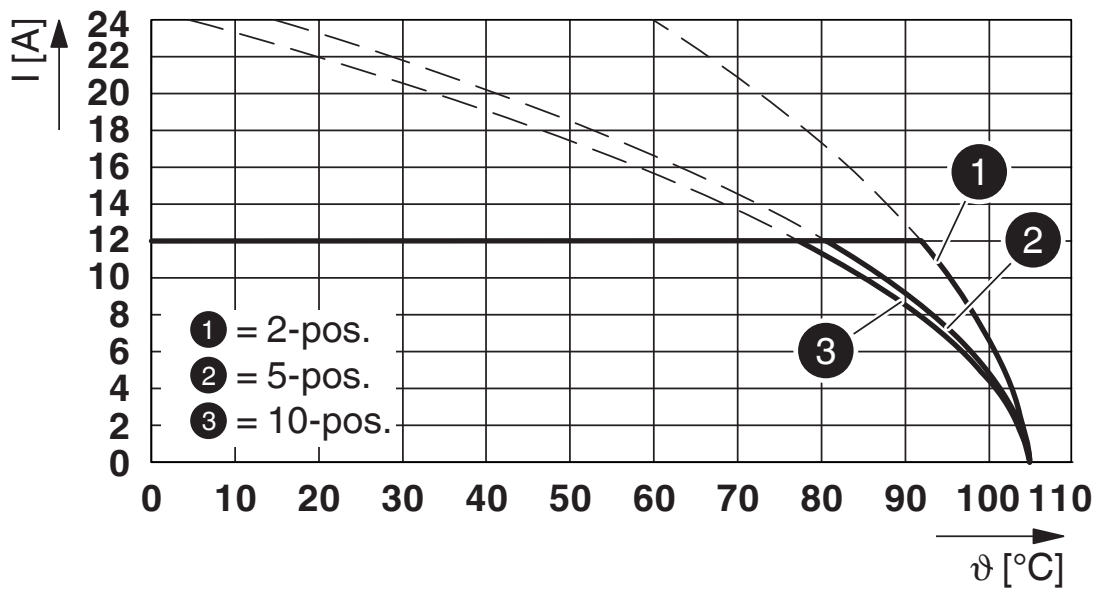

Type: TFKC 2,5/...-ST-5,08 with SMSTB 2,5/...-G-5,08

TFKC 2,5/ 3-ST-5,08 - PCB connector



1962613

<https://www.phoenixcontact.com/us/products/1962613>

Diagram

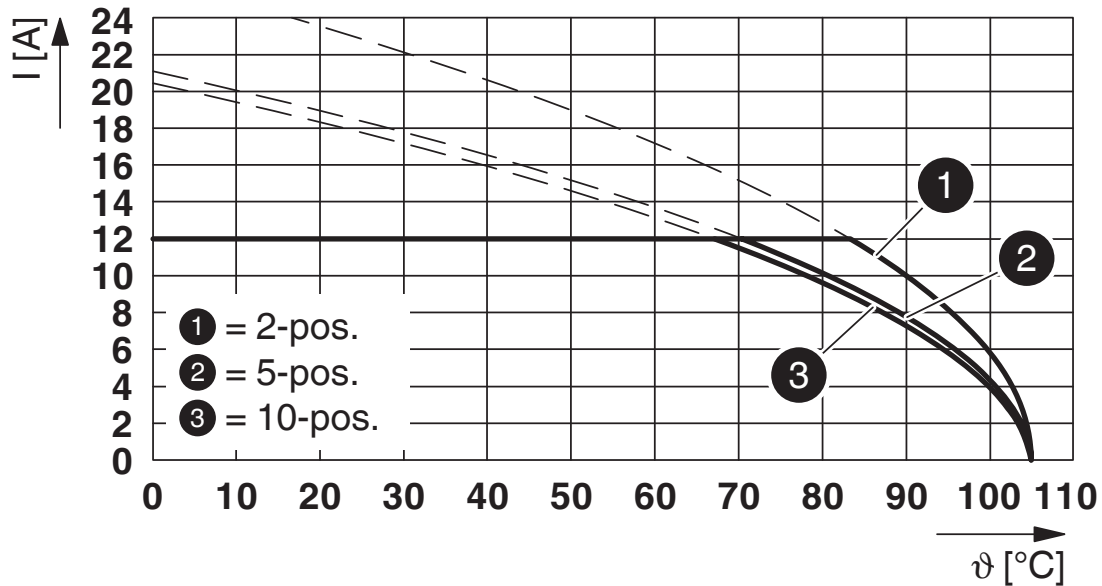

Type: TFKC 2,5/...-ST-5,08 with MSTBW 2,5/...-G-5,08

Diagram



Type: TFKC 2,5/...-ST-5,08 with MSTBV 2,5/...-G-5,08

TFKC 2,5/ 3-ST-5,08 - PCB connector

1962613

<https://www.phoenixcontact.com/us/products/1962613>



Circuit diagram

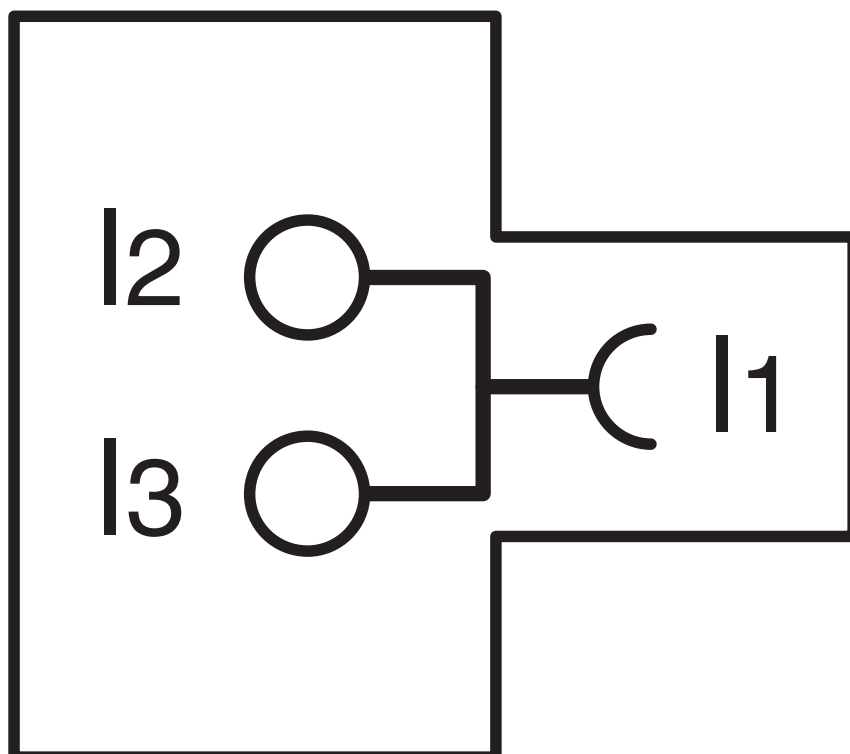

TFKC 2,5/ 3-ST-5,08 - PCB connector



1962613

<https://www.phoenixcontact.com/us/products/1962613>

Approvals

To download certificates, visit the product detail page: <https://www.phoenixcontact.com/us/products/1962613>

 cULus Recognized Approval ID: E60425-19931011				
	Nominal voltage U_N	Nominal current I_N	Cross section AWG	Cross section mm^2
B	300 V	10 A	26 - 12	-
D	300 V	10 A	26 - 12	-

 VDE approval of drawings Approval ID: 40050694				
	Nominal voltage U_N	Nominal current I_N	Cross section AWG	Cross section mm^2
keine	250 V	12 A	-	0.2 - 2.5

TFKC 2,5/ 3-ST-5,08 - PCB connector



1962613

<https://www.phoenixcontact.com/us/products/1962613>

Classifications

ECLASS

ECLASS-13.0	27460202
ECLASS-15.0	27460202

ETIM

ETIM 10.0	EC002638
-----------	----------

UNSPSC

UNSPSC 21.0	39121400
-------------	----------

TFKC 2,5/ 3-ST-5,08 - PCB connector



1962613

<https://www.phoenixcontact.com/us/products/1962613>

Environmental product compliance

EU RoHS

Fulfills EU RoHS substance requirements	Yes, No exemptions
---	--------------------

China RoHS

Environment friendly use period (EFUP)	EFUP-E
	No hazardous substances above the limits

EU REACH SVHC

REACH candidate substance (CAS No.)	No substance above 0.1 wt%
-------------------------------------	----------------------------

EF3.1 Climate Change

CO2e kg	0.148 kg CO2e
---------	---------------

Phoenix Contact 2026 © - all rights reserved
<https://www.phoenixcontact.com>

Phoenix Contact USA
586 Fulling Mill Road
Middletown, PA 17057, United States
(+717) 944-1300
info@phoenixcon.com