

MCVU 1,5/14-GFD-3,81 - Direct plug-in block



1833140

<https://www.phoenixcontact.com/us/products/1833140>

Please be informed that the data shown in this PDF document is generated from our online catalog. Please find the complete data in the user documentation. Our general terms of use for downloads are valid.



The figure shows a 10-position version of the product

Direct plug-in block, nominal cross section: 1.5 mm², color: green, nominal current: 8 A, rated voltage (III/2): 160 V, contact surface: Sn, contact connection type: Pin, number of potentials: 14, number of rows: 1, number of positions: 14, number of connections: 14, product range: MCVU 1,5/...-GFD, pitch: 3.81 mm, connection method: Screw connection with tension sleeve, screw head form: L Slotted, mounting: Direct mounting, conductor/PCB connection direction: 0 °, number of solder pins per potential: 1, plug-in system: COMBICON MC 1,5, locking: Screw locking mechanism, mounting method: Threaded flange, type of packaging: packed in cardboard

Your advantages

- Screwable flange for superior mechanical stability
- Laterally mounted flange for screw connection in the housing or on the mounting panel
- Maximum flexibility when it comes to device design – one header for connectors with different connection technologies

Commercial data

Item number	1833140
Packing unit	50 pc
Minimum order quantity	50 pc
Sales key	AA02
Product key	AABMBA
GTIN	4017918051839
Weight per piece (including packing)	15.02 g
Weight per piece (excluding packing)	14.6 g
Customs tariff number	85366990
Country of origin	PL

MCVU 1,5/14-GFD-3,81 - Direct plug-in block



1833140

<https://www.phoenixcontact.com/us/products/1833140>

Technical data

Product properties

Product type	Direct plug-in block
Product family	MCVU 1,5/..-GFD
Product line	COMBICON Connectors S
Type	Direct mounting
Number of positions	14
Pitch	3.81 mm
Number of connections	14
Number of rows	1
Number of potentials	14
Mounting type	Threaded flange
Solder pins per potential	1

Electrical properties

Properties

Nominal current I_N	8 A
Nominal voltage U_N	160 V
Contact resistance	3.5 m Ω
Rated voltage (III/3)	160 V
Rated surge voltage (III/3)	2.5 kV
Rated voltage (III/2)	160 V
Rated surge voltage (III/2)	2.5 kV
Rated voltage (II/2)	320 V
Rated surge voltage (II/2)	2.5 kV

Connection data

Connection technology

Type	Direct mounting
Connector system	COMBICON MC 1,5
Nominal cross section	1.5 mm ²
Contact connection type	Pin

Interlock

Locking type	Screw locking mechanism
Mounting type	Threaded flange
Tightening torque	0.3 Nm

Conductor connection

Connection method	Screw connection with tension sleeve
Connection direction of the conductor to plug-in direction	0 °
Conductor cross-section rigid	0.14 mm ² ... 1.5 mm ²

MCVU 1,5/14-GFD-3,81 - Direct plug-in block



1833140

<https://www.phoenixcontact.com/us/products/1833140>

Conductor cross-section flexible	0.14 mm ² ... 1.5 mm ²
Conductor cross-section AWG	28 ... 16
Conductor cross-section, flexible, with ferrule, without plastic sleeve	0.25 mm ² ... 1.5 mm ²
Conductor cross-section, flexible, with ferrule, with plastic sleeve	0.25 mm ² ... 0.5 mm ²
2 conductors with same cross section, rigid	0.14 mm ² ... 0.5 mm ²
2 conductors with same cross section, flexible	0.14 mm ² ... 0.75 mm ²
2 conductors with same cross section, flexible, with ferrule without plastic sleeve	0.25 mm ² ... 0.34 mm ²
2 conductors with the same cross section, flexible, with TWIN ferrule with plastic sleeve	0.5 mm ² ... 0.5 mm ²
Cylindrical gauge a x b / diameter	2.4 mm x 1.5 mm / 1.6 mm
Stripping length	7 mm
Tightening torque	0.22 Nm ... 0.25 Nm

Mounting

Mounting type	Direct mounting
---------------	-----------------

Flange

Tightening torque	0.3 Nm
-------------------	--------

Material specifications

Material data - contact

Note	WEEE/RoHS-compliant, free of whiskers according to IEC 60068-2-82/JEDEC JESD 201
Contact material	Cu alloy
Surface characteristics	Tin-plated
Metal surface terminal point (top layer)	Tin (5 µm - 7 µm Sn)
Metal surface terminal point (middle layer)	Nickel (2 µm - 3 µm Ni)
Metal surface contact area (top layer)	Tin (5 µm - 7 µm Sn)
Metal surface contact area (middle layer)	Nickel (2 µm - 3 µm Ni)

Material data - housing

Color (Housing)	green (6021)
Insulating material	PA
Insulating material group	I
CTI according to IEC 60112	600
Flammability rating according to UL 94	V0
Glow wire flammability index GWFI according to EN 60695-2-12	850
Glow wire ignition temperature GWIT according to EN 60695-2-13	775
Temperature for the ball pressure test according to EN 60695-10-2	125 °C

Notes

MCVU 1,5/14-GFD-3,81 - Direct plug-in block



1833140

<https://www.phoenixcontact.com/us/products/1833140>

Notes on operation	In accordance with IEC 61984, COMBICON connectors have no switching power (COC). During designated use, they must not be plugged in or disconnected when carrying voltage or under load.
--------------------	--

Dimensions

Pitch	3.81 mm
Width [w]	63.73 mm
Height [h]	12.5 mm
Length [l]	20.3 mm

Mechanical tests

Conductor connection

Specification	IEC 60999-1:1999-11
Result	Test passed

Test for conductor damage and slackening

Specification	IEC 60999-1:1999-11
Result	Test passed

Repeated connection and disconnection

Specification	IEC 60999-1:1999-11
Result	Test passed

Pull-out test

Specification	IEC 60999-1:1999-11
Conductor cross-section/conductor type/tractive force setpoint/actual value	0.14 mm ² / solid / > 10 N
	0.14 mm ² / flexible / > 10 N
	1.5 mm ² / solid / > 40 N
	1.5 mm ² / flexible / > 40 N

Insertion and withdrawal forces

Result	Test passed
No. of cycles	25
Insertion strength per pos. approx.	8 N
Withdraw strength per pos. approx.	6 N

Contact holder in insert

Specification	IEC 60512-15-1:2008-05
Contact holder in insert Requirements >20 N	Test passed

Resistance of inscriptions

Specification	IEC 60068-2-70:1995-12
Result	Test passed

Polarization and coding

Specification	IEC 60512-13-5:2006-02
Result	Test passed

MCVU 1,5/14-GFD-3,81 - Direct plug-in block



1833140

<https://www.phoenixcontact.com/us/products/1833140>

Visual inspection

Specification	IEC 60512-1-1:2002-02
Result	Test passed

Dimension check

Specification	IEC 60512-1-2:2002-02
Result	Test passed

Electrical tests

Thermal test | Test group C

Specification	IEC 60512-5-1:2002-02
Tested number of positions	16

Insulation resistance

Specification	IEC 60512-3-1:2002-02
Insulation resistance, neighboring positions	> 5 MΩ

Air clearances and creepage distances |

Specification	IEC 60664-1:2007-04
Insulating material group	I
Comparative tracking index (IEC 60112)	CTI 600
Rated insulation voltage (III/3)	160 V
Rated surge voltage (III/3)	2.5 kV
minimum clearance value - non-homogenous field (III/3)	1.5 mm
minimum creepage distance (III/3)	2 mm
Rated insulation voltage (III/2)	160 V
Rated surge voltage (III/2)	2.5 kV
minimum clearance value - non-homogenous field (III/2)	1.5 mm
minimum creepage distance (III/2)	1.5 mm
Rated insulation voltage (II/2)	320 V
Rated surge voltage (II/2)	2.5 kV
minimum clearance value - non-homogenous field (II/2)	1.5 mm
minimum creepage distance (II/2)	1.6 mm

Environmental and real-life conditions

Durability test

Specification	IEC 60512-9-1:2010-03
Impulse withstand voltage at sea level	2.95 kV
Contact resistance R ₁	3.5 mΩ
Contact resistance R ₂	3.7 mΩ
Insertion/withdrawal cycles	25
Insulation resistance, neighboring positions	> 5 MΩ

Climatic test

MCVU 1,5/14-GFD-3,81 - Direct plug-in block



1833140

<https://www.phoenixcontact.com/us/products/1833140>

Specification	ISO 6988:1985-02
Corrosive stress	0.2 dm ³ SO ₂ on 300 dm ³ /40 °C/1 cycle
Thermal stress	100 °C/168 h
Power-frequency withstand voltage	1.39 kV

Vibration test

Specification	IEC 60068-2-6:2007-12
Frequency	10 - 150 - 10 Hz
Sweep speed	1 octave/min
Amplitude	0.35 mm (10 Hz ... 60.1 Hz)
Acceleration	5g (60.1 Hz ... 150 Hz)
Test duration per axis	2.5 h
Test directions	X-, Y- and Z-axis

Ambient conditions

Ambient temperature (storage/transport)	-40 °C ... 70 °C
Relative humidity (storage/transport)	30 % ... 70 %
Ambient temperature (assembly)	-5 °C ... 100 °C
Ambient temperature (operation)	-40 °C ... 100 °C (dependent on the derating curve)

Ambient conditions

Ambient temperature (operation)	-40 °C ... 100 °C (dependent on the derating curve)
Ambient temperature (storage/transport)	-40 °C ... 70 °C
Relative humidity (storage/transport)	30 % ... 70 %
Ambient temperature (assembly)	-5 °C ... 100 °C

Packaging specifications

Type of packaging	packed in cardboard
-------------------	---------------------

1833140

<https://www.phoenixcontact.com/us/products/1833140>

Drawings

Dimensional drawing



Diagram



Type: FK-MCP 1,5/...-ST-3,81 with MCVU 1,5/...-GFD-3,81



Type: FMC 1,5/...-ST-3,81 with MCVU 1,5/...-GFD-3,81



Type: MC 1,5/...-ST-3,81 with MCVU 1,5/...-GFD-3,81

1833140

<https://www.phoenixcontact.com/us/products/1833140>

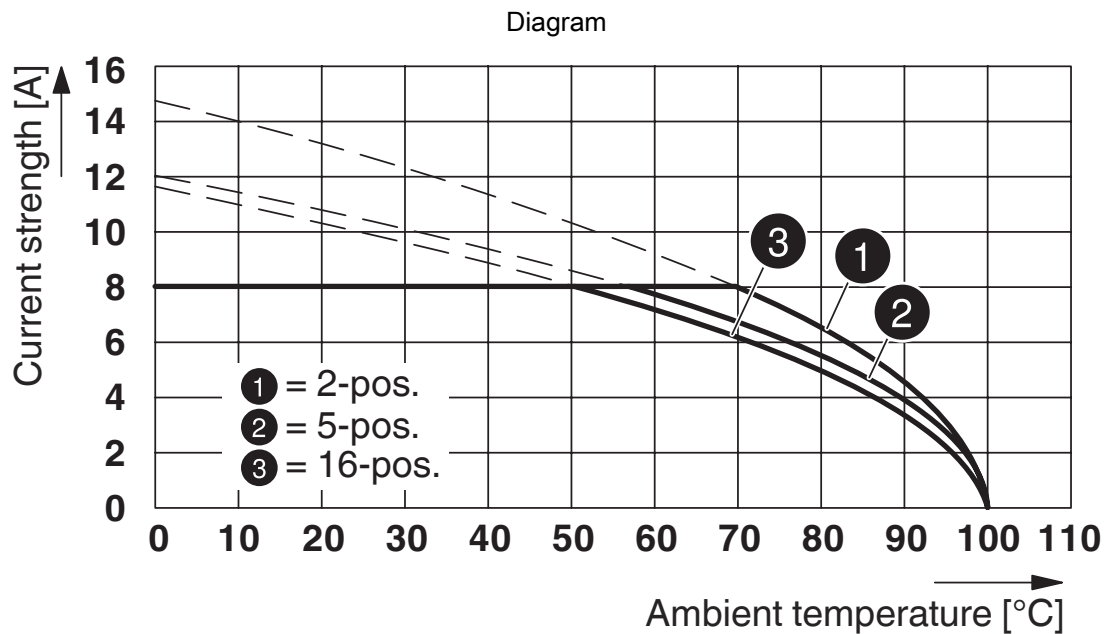

Type: MCVR 1,5/...-STF-3,81 with MCVU 1,5/...-GFD-3,81

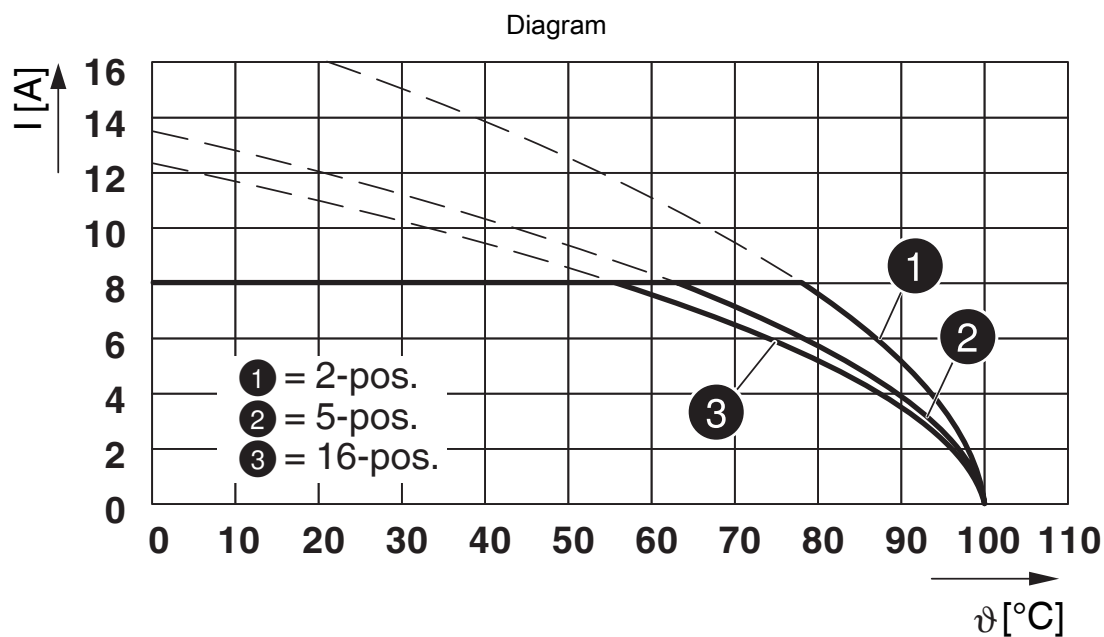

Type: FRONT-MC 1,5/...-STF-3,81 with MCVU 1,5/...-GFD-3,81

MCVU 1,5/14-GFD-3,81 - Direct plug-in block



1833140

<https://www.phoenixcontact.com/us/products/1833140>

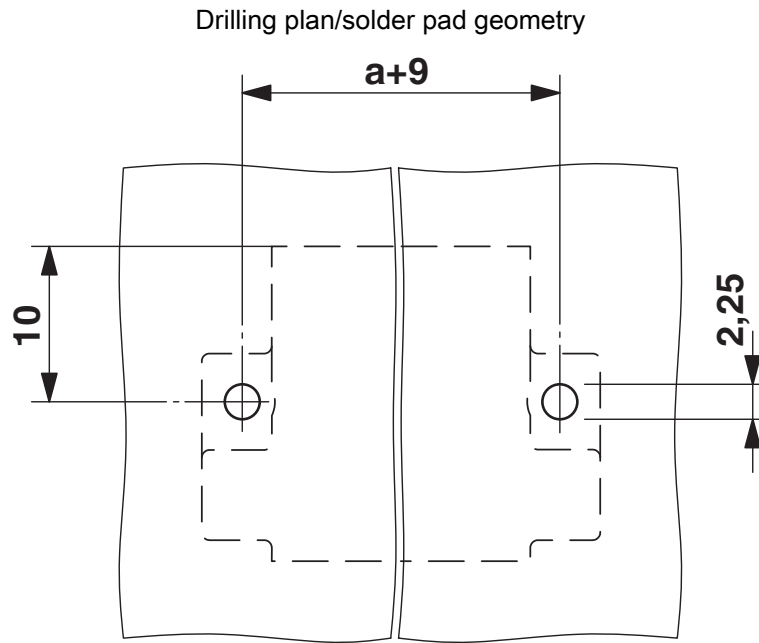

MCVU 1,5/14-GFD-3,81 - Direct plug-in block



1833140

<https://www.phoenixcontact.com/us/products/1833140>

Approvals

To download certificates, visit the product detail page: <https://www.phoenixcontact.com/us/products/1833140>

 CSA Approval ID: 13631				
	Nominal voltage U_N	Nominal current I_N	Cross section AWG	Cross section mm^2
B				
	300 V	8 A	28 - 16	-
D				
	300 V	8 A	28 - 16	-

 cULus Recognized Approval ID: E60425-20110128				
	Nominal voltage U_N	Nominal current I_N	Cross section AWG	Cross section mm^2
B				
	300 V	8 A	30 - 14	-
D				
	300 V	8 A	30 - 14	-

 VDE Zeichengenehmigung Approval ID: 40011723				
	Nominal voltage U_N	Nominal current I_N	Cross section AWG	Cross section mm^2
keine				
	160 V	8 A	-	-

MCVU 1,5/14-GFD-3,81 - Direct plug-in block



1833140

<https://www.phoenixcontact.com/us/products/1833140>

Classifications

ECLASS

ECLASS-13.0	27460202
ECLASS-15.0	27460202

ETIM

ETIM 10.0	EC002638
-----------	----------

UNSPSC

UNSPSC 21.0	39121400
-------------	----------

MCVU 1,5/14-GFD-3,81 - Direct plug-in block



1833140

<https://www.phoenixcontact.com/us/products/1833140>

Environmental product compliance

EU RoHS

Fulfills EU RoHS substance requirements	Yes, No exemptions
---	--------------------

China RoHS

Environment friendly use period (EFUP)	EFUP-E
	No hazardous substances above the limits

EU REACH SVHC

REACH candidate substance (CAS No.)	No substance above 0.1 wt%
-------------------------------------	----------------------------

EF3.1 Climate Change

CO2e kg	0.158 kg CO2e
---------	---------------

Phoenix Contact 2026 © - all rights reserved
<https://www.phoenixcontact.com>

Phoenix Contact USA
586 Fulling Mill Road
Middletown, PA 17057, United States
(+717) 944-1300
info@phoenixcon.com