

MSTB 2,5/ 8-STZF-5,08 - PCB connector

1810480

<https://www.phoenixcontact.com/us/products/1810480>

Please be informed that the data shown in this PDF document is generated from our online catalog. Please find the complete data in the user documentation. Our general terms of use for downloads are valid.



PCB connector, nominal cross section: 2.5 mm², color: green, nominal current: 12 A, rated voltage (III/2): 320 V, contact surface: Sn, contact connection type: Socket, number of potentials: 8, number of rows: 1, number of positions: 8, number of connections: 8, product range: MSTB 2,5/...-STF, pitch: 5.08 mm, connection method: Screw connection with tension sleeve, screw head form: L Slotted, conductor/PCB connection direction: 0 °, locking clip: - without locking clip, plug-in system: COMBICON MSTB 2,5, locking: Screw locking mechanism, mounting method: Screw flange, type of packaging: packed in cardboard

Your advantages

- Well-known connection principle allows worldwide use
- Pull-out aid facilitates handling and allows the tensile force to be reduced at the contact point
- Screwable flange for superior mechanical stability
- Allows connection of two conductors

Commercial data

Item number	1810480
Packing unit	50 pc
Minimum order quantity	50 pc
Note	Made to order (non-returnable)
Sales key	AA03
Product key	AACAGD
GTIN	4017918330347
Weight per piece (including packing)	16.73 g
Weight per piece (excluding packing)	15.715 g
Customs tariff number	85366990
Country of origin	DE

MSTB 2,5/ 8-STZF-5,08 - PCB connector



1810480

<https://www.phoenixcontact.com/us/products/1810480>

Technical data

Product properties

Product type	PCB connector
Product family	MSTB 2,5/...-STF
Product line	COMBICON Connectors M
Number of positions	8
Pitch	5.08 mm
Number of connections	8
Number of rows	1
Number of potentials	8
Mounting type	Screw flange

Electrical properties

Properties

Nominal current I_N	12 A
Nominal voltage U_N	320 V
Rated voltage (III/3)	250 V
Rated surge voltage (III/3)	4 kV
Rated voltage (III/2)	320 V
Rated surge voltage (III/2)	4 kV
Rated voltage (II/2)	630 V
Rated surge voltage (II/2)	4 kV

Connection data

Connection technology

Connector system	COMBICON MSTB 2,5
Nominal cross section	2.5 mm ²
Contact connection type	Socket

Interlock

Locking type	Screw locking mechanism
Mounting type	Screw flange
Tightening torque	0.3 Nm

Conductor connection

Connection method	Screw connection with tension sleeve
Conductor/PCB connection direction	0 °
Conductor cross-section rigid	0.2 mm ² ... 2.5 mm ²
Conductor cross-section flexible	0.2 mm ² ... 2.5 mm ²
Conductor cross-section AWG	24 ... 12
Conductor cross-section, flexible, with ferrule, without plastic sleeve	0.25 mm ² ... 2.5 mm ²
Conductor cross-section, flexible, with ferrule, with plastic sleeve	0.25 mm ² ... 2.5 mm ²

MSTB 2,5/ 8-STZF-5,08 - PCB connector



1810480

<https://www.phoenixcontact.com/us/products/1810480>

2 conductors with same cross section, rigid	0.2 mm ² ... 1 mm ²
2 conductors with same cross section, flexible	0.2 mm ² ... 1.5 mm ²
2 conductors with same cross section, flexible, with ferrule without plastic sleeve	0.25 mm ² ... 1 mm ²
2 conductors with the same cross section, flexible, with TWIN ferrule with plastic sleeve	0.5 mm ² ... 1.5 mm ²
Stripping length	7 mm
Drive form screw head	Slotted (L)
Tightening torque	0.5 Nm ... 0.6 Nm

Specifications for ferrules without insulating collar

recommended crimping tool	1212034 CRIMPFOX 6
---------------------------	--------------------

Specifications for ferrules with insulating collar

recommended crimping tool	1212034 CRIMPFOX 6
---------------------------	--------------------

Material specifications

Material data - contact

Note	WEEE/RoHS-compliant, free of whiskers according to IEC 60068-2-82/JEDEC JESD 201
Contact material	Cu alloy
Surface characteristics	hot-dip tin-plated
Metal surface terminal point (top layer)	Tin (5 µm - 7 µm Sn)
Metal surface contact area (top layer)	Tin (5 µm - 7 µm Sn)

Material data - housing

Color (Housing)	green (6021)
Insulating material	PA
Insulating material group	I
CTI according to IEC 60112	600
Flammability rating according to UL 94	V0
Glow wire flammability index GWFI according to EN 60695-2-12	850
Glow wire ignition temperature GWIT according to EN 60695-2-13	775
Temperature for the ball pressure test according to EN 60695-10-2	125 °C

Dimensions

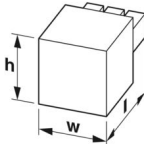
Dimensional drawing	
Pitch	5.08 mm
Width [w]	50.65 mm
Height [h]	15.5 mm

MSTB 2,5/ 8-STZF-5,08 - PCB connector



1810480

<https://www.phoenixcontact.com/us/products/1810480>

Length [l]	54.3 mm
------------	---------

Mounting

Flange

Tightening torque	0.3 Nm
-------------------	--------

Notes

Notes on operation	In accordance with IEC 61984, COMBICON connectors have no switching power (COC). During designated use, they must not be plugged in or disconnected when carrying voltage or under load.
--------------------	--

Environmental and real-life conditions

Ambient conditions

Relative humidity (storage/transport)	30 % ... 70 %
---------------------------------------	---------------

Electrical tests

Air clearances and creepage distances |

Insulating material group	I
Rated insulation voltage (III/3)	250 V
Rated surge voltage (III/3)	4 kV
Rated insulation voltage (III/2)	320 V
Rated surge voltage (III/2)	4 kV
Rated insulation voltage (II/2)	630 V
Rated surge voltage (II/2)	4 kV

Packaging specifications

Type of packaging	packed in cardboard
-------------------	---------------------

MSTB 2,5/ 8-STZF-5,08 - PCB connector





1810480

<https://www.phoenixcontact.com/us/products/1810480>

Approvals

To download certificates, visit the product detail page: <https://www.phoenixcontact.com/us/products/1810480>

 CSA Approval ID: 13631-2585951				
	Nominal voltage U_N	Nominal current I_N	Cross section AWG	Cross section mm^2
B	300 V	15 A	28 - 12	-
D	300 V	10 A	28 - 12	-

 VDE Zeichengenehmigung Approval ID: 40050694				
	Nominal voltage U_N	Nominal current I_N	Cross section AWG	Cross section mm^2
keine	250 V	12 A	-	0.2 - 2.5

MSTB 2,5/ 8-STZF-5,08 - PCB connector



1810480

<https://www.phoenixcontact.com/us/products/1810480>

Classifications

ECLASS

ECLASS-13.0	27460202
ECLASS-15.0	27460202

ETIM

ETIM 10.0	EC002638
-----------	----------

UNSPSC

UNSPSC 21.0	39121400
-------------	----------

MSTB 2,5/ 8-STZF-5,08 - PCB connector



1810480

<https://www.phoenixcontact.com/us/products/1810480>

Environmental product compliance

EU RoHS

Fulfills EU RoHS substance requirements	Yes, No exemptions
---	--------------------

China RoHS

Environment friendly use period (EFUP)	EFUP-E
	No hazardous substances above the limits

EU REACH SVHC

REACH candidate substance (CAS No.)	No substance above 0.1 wt%
-------------------------------------	----------------------------

Phoenix Contact 2026 © - all rights reserved
<https://www.phoenixcontact.com>

Phoenix Contact USA
586 Fulling Mill Road
Middletown, PA 17057, United States
(+717) 944-1300
info@phoenixcon.com