

MC 1,5/ 6-STZ2-3,81 - PCB connector

1767694

<https://www.phoenixcontact.com/us/products/1767694>

Please be informed that the data shown in this PDF document is generated from our online catalog. Please find the complete data in the user documentation. Our general terms of use for downloads are valid.

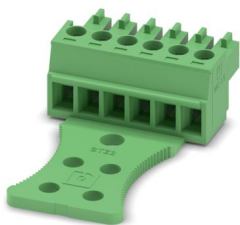

PCB connector, nominal cross section: 1.5 mm², color: green, nominal current: 8 A, rated voltage (III/2): 160 V, contact surface: Sn, contact connection type: Socket, number of potentials: 6, number of rows: 1, number of positions: 6, number of connections: 6, product range: MC 1,5/-ST, pitch: 3.81 mm, connection method: Screw connection with tension sleeve, screw head form: L Slotted, conductor/PCB connection direction: 0 °, plug-in system: COMBICON MC 1,5, locking: without, mounting method: without, type of packaging: packed in cardboard, Pull-out aid (STZ2)

Your advantages

- Well-known connection principle allows worldwide use
- Low temperature rise, thanks to maximum contact force
- Allows connection of two conductors
- Pull-out aid facilitates handling and allows the tensile force to be reduced at the contact point

Commercial data

Item number	1767694
Packing unit	50 pc
Minimum order quantity	50 pc
Sales key	AA02
Product key	AABABA
GTIN	4046356436540
Weight per piece (including packing)	5.23 g
Weight per piece (excluding packing)	4.854 g
Customs tariff number	85366990
Country of origin	DE

MC 1,5/ 6-STZ2-3,81 - PCB connector



1767694

<https://www.phoenixcontact.com/us/products/1767694>

Technical data

Product properties

Product type	PCB connector
Product family	MC 1,5/...-ST
Product line	COMBICON Connectors S
Number of positions	6
Pitch	3.81 mm
Number of connections	6
Number of rows	1
Number of potentials	6
Mounting type	without
Strain relief	STZ2 Pull-out aid 17.2 x 25.5 mm

Electrical properties

Properties

Nominal current I_N	8 A
Nominal voltage U_N	160 V
Rated voltage (III/3)	160 V
Rated surge voltage (III/3)	2.5 kV
Rated voltage (III/2)	160 V
Rated surge voltage (III/2)	2.5 kV
Rated voltage (II/2)	320 V
Rated surge voltage (II/2)	2.5 kV

Connection data

Connection technology

Connector system	COMBICON MC 1,5
Nominal cross section	1.5 mm ²
Contact connection type	Socket

Interlock

Locking type	without
Mounting type	without

Conductor connection

Connection method	Screw connection with tension sleeve
Conductor/PCB connection direction	0 °
Conductor cross-section rigid	0.08 mm ² ... 1.5 mm ²
Conductor cross-section flexible	0.08 mm ² ... 1.5 mm ²
Conductor cross-section AWG	28 ... 16
Conductor cross-section, flexible, with ferrule, without plastic sleeve	0.25 mm ² ... 1.5 mm ²
Conductor cross-section, flexible, with ferrule, with plastic sleeve	0.25 mm ² ... 0.75 mm ²

MC 1,5/ 6-STZ2-3,81 - PCB connector



1767694

<https://www.phoenixcontact.com/us/products/1767694>

2 conductors with same cross section, rigid	0.08 mm ² ... 0.5 mm ²
2 conductors with same cross section, flexible	0.08 mm ² ... 0.75 mm ²
2 conductors with same cross section, flexible, with ferrule without plastic sleeve	0.25 mm ² ... 0.34 mm ²
2 conductors with the same cross section, flexible, with TWIN ferrule with plastic sleeve	0.5 mm ² ... 0.5 mm ²
Cylindrical gauge a x b / diameter	2.4 mm x 1.5 mm / 1.6 mm
Stripping length	7 mm
Drive form screw head	Slotted (L)
Tightening torque	0.22 Nm ... 0.25 Nm

Specifications for ferrules without insulating collar

recommended crimping tool	1212034 CRIMPFOX 6
---------------------------	--------------------

Specifications for ferrules with insulating collar

recommended crimping tool	1212034 CRIMPFOX 6
---------------------------	--------------------

Material specifications

Material data - contact

Note	WEEE/RoHS-compliant, free of whiskers according to IEC 60068-2-82/JEDEC JESD 201
Contact material	Cu alloy
Surface characteristics	hot-dip tin-plated
Metal surface terminal point (top layer)	Tin (4 µm - 8 µm Sn)
Metal surface contact area (top layer)	Tin (4 µm - 8 µm Sn)

Material data - housing

Color (Housing)	green (6021)
Insulating material	PA
Insulating material group	I
CTI according to IEC 60112	600
Flammability rating according to UL 94	V0
Glow wire flammability index GWFI according to EN 60695-2-12	850
Glow wire ignition temperature GWIT according to EN 60695-2-13	775
Temperature for the ball pressure test according to EN 60695-10-2	125 °C

Dimensions

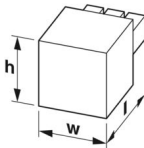
Dimensional drawing	
Pitch	3.81 mm
Width [w]	23.65 mm

MC 1,5/ 6-STZ2-3,81 - PCB connector



1767694

<https://www.phoenixcontact.com/us/products/1767694>

Height [h]	11.6 mm
Length [l]	41 mm

Notes

Note on application	The 0.08 mm ² conductors must be placed in the center of the clamping space when installing them. This must be checked after installation.
---------------------	---

Environmental and real-life conditions

Ambient conditions

Ambient temperature (storage/transport)	-40 °C ... 70 °C
Relative humidity (storage/transport)	30 % ... 70 %
Ambient temperature (assembly)	-5 °C ... 100 °C
Ambient temperature (operation)	-40 °C ... 100 °C (dependent on the derating curve)

Electrical tests

Air clearances and creepage distances |

Specification	IEC 60664-1:2007-04
Insulating material group	I
Comparative tracking index (IEC 60112)	CTI 600
Rated insulation voltage (III/3)	160 V
Rated surge voltage (III/3)	2.5 kV
minimum clearance value - non-homogenous field (III/3)	1.5 mm
minimum creepage distance (III/3)	2 mm
Note on connection cross section	With connected conductor 1.5 mm ² (solid).
Rated insulation voltage (III/2)	160 V
Rated surge voltage (III/2)	2.5 kV
minimum clearance value - non-homogenous field (III/2)	1.5 mm
minimum creepage distance (III/2)	1.5 mm
Rated insulation voltage (II/2)	320 V
Rated surge voltage (II/2)	2.5 kV
minimum clearance value - non-homogenous field (II/2)	1.5 mm
minimum creepage distance (II/2)	1.6 mm

Packaging specifications

Type of packaging	packed in cardboard
-------------------	---------------------

MC 1,5/ 6-STZ2-3,81 - PCB connector



1767694

<https://www.phoenixcontact.com/us/products/1767694>

Drawings

Dimensional drawing



MC 1,5/ 6-STZ2-3,81 - PCB connector



1767694

<https://www.phoenixcontact.com/us/products/1767694>

Approvals

To download certificates, visit the product detail page: <https://www.phoenixcontact.com/us/products/1767694>

 cULus Recognized Approval ID: E60425-20110128		Nominal voltage U_N	Nominal current I_N	Cross section AWG	Cross section mm^2
B		300 V	8 A	30 - 14	-
D		300 V	8 A	30 - 14	-

MC 1,5/ 6-STZ2-3,81 - PCB connector



1767694

<https://www.phoenixcontact.com/us/products/1767694>

Classifications

ECLASS

ECLASS-13.0	27460202
ECLASS-15.0	27460202

ETIM

ETIM 10.0	EC002638
-----------	----------

UNSPSC

UNSPSC 21.0	39121400
-------------	----------

MC 1,5/ 6-STZ2-3,81 - PCB connector



1767694

<https://www.phoenixcontact.com/us/products/1767694>

Environmental product compliance

EU RoHS

Fulfills EU RoHS substance requirements	Yes, No exemptions
---	--------------------

China RoHS

Environment friendly use period (EFUP)	EFUP-E
	No hazardous substances above the limits

EU REACH SVHC

REACH candidate substance (CAS No.)	No substance above 0.1 wt%
-------------------------------------	----------------------------

Phoenix Contact 2026 © - all rights reserved
<https://www.phoenixcontact.com>

Phoenix Contact USA
586 Fulling Mill Road
Middletown, PA 17057, United States
(+717) 944-1300
info@phoenixcon.com