

SAC-3P-M 8MS-M12FR-2L/.../... - Sensor/actuator cable



1697713

<https://www.phoenixcontact.com/us/products/1697713>

Please be informed that the data shown in this PDF document is generated from our online catalog. Please find the complete data in the user documentation. Our general terms of use for downloads are valid.



Sensor/actuator cable, 3-position, Variable cable type, Plug straight M8, coding: A, with 2 LEDs, on Socket angled M12, coding: A, with 2 LEDs, cable length: Free input (0.2 ... 40.0 m)

Your advantages

- Easy and safe: 100 % electrically tested plug-in components
- Convenient: increased machine availability thanks to quick and easy diagnostics

Commercial data

Item number	1697713
Packing unit	1 pc
Minimum order quantity	1 pc
Note	Made to order (non-returnable)
Sales key	BF17
Product key	AF1CBA
Customs tariff number	85444290
Country of origin	PL

SAC-3P-M 8MS-M12FR-2L/.../... - Sensor/actuator cable



1697713

<https://www.phoenixcontact.com/us/products/1697713>

Technical data

Product properties

Product type	Sensor/actuator cable
Application	Standard
	Robots and drag chains
Number of positions	3
No. of cable outlets	1
Shielded	no
Coding	A

Insulation characteristics

Overvoltage category	II
Degree of pollution	3

Material specifications

Flammability rating according to UL 94	HB
Seal material	NBR
Material of grip body	TPU, hardly inflammable, self-extinguishing
Contact material	CuSn
Contact surface material	Ni/Au
Contact carrier material	TPU GF
Material for screw connection	Zinc die-cast, nickel-plated

Electrical properties

Insulation resistance	$\geq 100 \text{ M}\Omega$
Nominal voltage U_N	24 V DC
Nominal current I_N	4 A

Mechanical properties

Mechanical data

Insertion/withdrawal cycles	≥ 100
-----------------------------	------------

Signaling

Status display	2 LEDs
Status display present	yes

Connection data

Conductor connection

Tightening torque	0.4 Nm (M12 connector)
	0.2 Nm (M8 connectors)

Connector

SAC-3P-M 8MS-M12FR-2L/.../... - Sensor/actuator cable



1697713

<https://www.phoenixcontact.com/us/products/1697713>

Connection 1

Type	Plug straight M8
Number of positions	3
Coding type	A

Connection 2

Type	Socket angled M12
Number of positions	3
Coding type	A

Cable/line

Cable length	Free input (0.2 ... 40.0 m)
--------------	-----------------------------

PUR halogen-free black [PUR]

Cable weight	18 kg/km
UL AWM Style	20549 / 10493 (80°C/300 V)
Number of positions	3
Shielded	no
Cable type	PUR halogen-free black [PUR] PUR halogen-free black PUR
Conductor structure signal line	32x 0.10 mm
AWG signal line	24
Conductor cross-section	3x 0.25 mm ² (Signal line)
Wire diameter incl. insulation	1.17 mm ±0.02 mm
External cable diameter	3.60 mm ±0.15 mm
Outer sheath, material	PUR
External sheath, color	black-gray RAL 7021
Conductor material	Bare Cu litz wires
Material wire insulation	PP
Single wire, color	brown, blue, black
Thickness, insulation	≥ 0.21 mm (Core insulation)
Thickness, outer sheath	approx. 0.50 mm
Overall twist	3 wires, twisted
Length of twist, overall twist	40 mm
Max. conductor resistance	≤ 78 Ω/km (at 20 °C)
Insulation resistance	≥ 100 GΩ*km (at 20 °C)
Nominal voltage, cable	≤ 300 V
Test voltage	≥ 3000 V
Smallest bending radius, fixed installation	18 mm
Smallest bending radius, movable installation	36 mm
Dynamic load capacity (bending)	Max. bending cycles: 10000000, Bending radius: 44 mm, Traversing path: 10 m, Traversing rate: 3 m/s, Acceleration: 10 m/s ²
Dynamic load capacity (torsion)	Torsion: ±180 °/m, Torsion cycles: ≥5000000, Torsional frequency: 35 cycles/min.

SAC-3P-M 8MS-M12FR-2L/.../... - Sensor/actuator cable



1697713

<https://www.phoenixcontact.com/us/products/1697713>

Halogen-free	in accordance with DIN VDE 0472 part 815
Flame resistance	in accordance with UL 758/1581 FT2 DIN EN 60332-2-2 (20 s)
Resistance to oil	in accordance with DIN EN 60811-2-1
Other resistance	hydrolysis and microbe resistant Highly resistant to acids, alkaline solutions and solvents Resistant to salt water partly UV-resistant (in accordance with DIN EN ISO 4892-2-A)
Special properties	Flexible cable conduit capable Silicone-free Free of substances which would hinder coating with paint or varnish
Ambient temperature (operation)	-40 °C ... 80 °C (cable, fixed installation) -25 °C ... 80 °C (Cable, flexible installation)

PUR halogen-free yellow [240]

Cable weight	24 kg/km
UL AWM Style	20549
Number of positions	3
Shielded	no
Cable type	PUR halogen-free yellow [240] PUR halogen-free yellow 240
Conductor structure signal line	32x 0.10 mm
AWG signal line	24
Conductor cross-section	3x 0.25 mm ² (Signal line)
Wire diameter incl. insulation	1.17 mm ±0.02 mm
External cable diameter	4.40 mm ±0.15 mm
Outer sheath, material	PUR
External sheath, color	yellow
Conductor material	Bare Cu litz wires
Material wire insulation	PP
Single wire, color	brown, blue, black
Thickness, insulation	≥ 0.21 mm
Thickness, outer sheath	approx. 0.90 mm
Overall twist	3 wires, twisted
Length of twist, overall twist	40 mm
Max. conductor resistance	78 Ω/km (at 20 °C)
Insulation resistance	≥ 1 GΩ*km (at 20 °C)
Nominal voltage, cable	≤ 300 V AC
Test voltage	≥ 3000 V AC (Spark test)
Minimum bending radius, fixed installation	5 x D
Minimum bending radius, flexible installation	10 x D
Smallest bending radius, fixed installation	22 mm
Smallest bending radius, movable installation	44 mm

SAC-3P-M 8MS-M12FR-2L/.../... - Sensor/actuator cable



1697713

<https://www.phoenixcontact.com/us/products/1697713>

Dynamic load capacity (bending)	Max. bending cycles: 10000000, Bending radius: 10 x D, Traversing path: 10 m, Traversing rate: 3 m/s, Acceleration: 10 m/s ²
Dynamic load capacity (torsion)	Torsion: ±180 °/m, Torsion cycles: ≥5000000, Torsional frequency: 35 cycles/min.
Halogen-free	in accordance with DIN VDE 0472 part 815
	in accordance with EN 50267-2-1
Flame resistance	in accordance with UL 758/1581 FT2
Resistance to oil	According to DIN EN 60811-2-1, 168 h at 100 °C
	according to UL 758, 168 h at 60 °C
Other resistance	hydrolysis and microbe resistant
	Resistant to salt water
	abrasion-resistant
	Low adhesion
Ambient temperature (operation)	-40 °C ... 80 °C (cable, fixed installation)
	-25 °C ... 80 °C (Cable, flexible installation)

PUR halogen-free orange [180]

Cable weight	24 kg/km
UL AWM Style	20549
Number of positions	3
Shielded	no
Cable type	PUR halogen-free orange [180]
	PUR halogen-free orange 180
Conductor structure signal line	32x 0.10 mm
AWG signal line	24
Conductor cross-section	3x 0.25 mm ² (Signal line)
Wire diameter incl. insulation	1.17 mm ±0.02 mm (Signal line)
External cable diameter	4.40 mm ±0.15 mm
Outer sheath, material	PUR
External sheath, color	orange RAL 2003
Conductor material	Bare Cu litz wires
Material wire insulation	PP
Single wire, color	brown, blue, black
Thickness, insulation	≥ 0.21 mm (Core insulation)
	approx. 0.90 mm (Outer cable sheath)
Overall twist	3 wires, twisted
Max. conductor resistance	max. 78 Ω/km (at 20 °C)
Insulation resistance	≥ 10 GΩ*km (at 20 °C)
Nominal voltage, cable	≤ 300 V
Test voltage	≥ 3000 V
Smallest bending radius, fixed installation	22 mm
Smallest bending radius, movable installation	44 mm
Dynamic load capacity (bending)	Max. bending cycles: 10000000, Bending radius: 44 mm, Traversing path: 10 m, Traversing rate: 3 m/s, Acceleration: 10 m/s ²

SAC-3P-M 8MS-M12FR-2L/.../... - Sensor/actuator cable



1697713

<https://www.phoenixcontact.com/us/products/1697713>

Dynamic load capacity (torsion)	Torsion: ± 180 °/m, Torsion cycles: ≥ 5000000 , Torsional frequency: 35 cycles/min.
Halogen-free	in accordance with DIN VDE 0472 part 815
Flame resistance	in accordance with DIN UL-Style 20549
	in accordance with UL 758/1581 FT2
Resistance to oil	in accordance with DIN EN 60811-2-1
Other resistance	hydrolysis and microbe resistant
	Resistant to salt water
Ambient temperature (operation)	-40 °C ... 80 °C (cable, fixed installation)
	-25 °C ... 80 °C (Cable, flexible installation)

PUR halogen-free gray [280]

Cable weight	18 kg/km
UL AWM Style	20549 / 10493 (80°C/300 V)
Number of positions	3
Shielded	no
Cable type	PUR halogen-free gray [280]
	PUR halogen-free gray 280
Conductor structure signal line	32x 0.10 mm
AWG signal line	24
Conductor cross-section	3x 0.25 mm ²
Wire diameter incl. insulation	1.17 mm \pm 0.02 mm
External cable diameter	3.60 mm \pm 0.15 mm
Outer sheath, material	PUR
External sheath, color	gray RAL 7001
Conductor material	Bare Cu litz wires
Material wire insulation	PP
Single wire, color	brown, blue, black
Thickness, insulation	≥ 0.21 mm (Core insulation)
Thickness, outer sheath	approx. 0.50 mm
Overall twist	3 wires, twisted
Length of twist, overall twist	40 mm
Max. conductor resistance	≤ 78 Ω /km (at 20 °C)
Insulation resistance	≥ 100 G Ω *km (at 20 °C)
Nominal voltage, cable	≤ 300 V
Test voltage	≥ 3000 V
Smallest bending radius, fixed installation	18 mm
Smallest bending radius, movable installation	36 mm
Dynamic load capacity (bending)	Max. bending cycles: 10000000, Bending radius: 44 mm, Traversing path: 10 m, Traversing rate: 3 m/s, Acceleration: 10 m/s ²
Dynamic load capacity (torsion)	Torsion: ± 180 °/m, Torsion cycles: ≥ 5000000 , Torsional frequency: 35 cycles/min.
Halogen-free	in accordance with DIN VDE 0472 part 815
Flame resistance	in accordance with UL 758/1581 FT2

SAC-3P-M 8MS-M12FR-2L/.../... - Sensor/actuator cable



1697713

<https://www.phoenixcontact.com/us/products/1697713>

	DIN EN 60332-2-2 (20 s)
Resistance to oil	in accordance with DIN EN 60811-2-1
Other resistance	hydrolysis and microbe resistant
	Highly resistant to acids, alkaline solutions and solvents
	Resistant to salt water
	partly UV-resistant (in accordance with DIN EN ISO 4892-2-A)
Special properties	Flexible cable conduit capable
	Silicone-free
	Free of substances which would hinder coating with paint or varnish
Ambient temperature (operation)	-40 °C ... 80 °C (cable, fixed installation)
	-25 °C ... 80 °C (Cable, flexible installation)

PVC black [PVC]

Cable weight	29 kg/km
Number of positions	3
Shielded	no
Cable type	PVC black [PVC]
	PVC black PVC
Conductor structure signal line	14x 0.15 mm
AWG signal line	24
Conductor cross-section	3x 0.25 mm ² (Signal line)
Wire diameter incl. insulation	1.17 mm ±0.05 mm
External cable diameter	4.20 mm ±0.15 mm
Outer sheath, material	PVC
External sheath, color	black RAL 9005
Conductor material	Bare Cu litz wires
Material wire insulation	PVC
Single wire, color	brown, blue, black
Thickness, insulation	≥ 0.23 mm (Core insulation)
Thickness, outer sheath	≥ 0.76 mm
Overall twist	3 wires, twisted
Max. conductor resistance	max. 79 Ω/km (at 20 °C)
Insulation resistance	≥ 100 MΩ*km (at 20 °C)
Nominal voltage, cable	≥ 300 V
Test voltage	≤ 3000 V
Smallest bending radius, fixed installation	13 mm
Flame resistance	As per UL-Style 2464
Resistance to oil	EN 60811-2-1
Ambient temperature (operation)	-25 °C ... 80 °C (cable, fixed installation)
	-10 °C ... 80 °C (Cable, flexible installation)

PVC gray [500]

Cable weight	29 kg/km
Number of positions	3

SAC-3P-M 8MS-M12FR-2L/.../... - Sensor/actuator cable



1697713

<https://www.phoenixcontact.com/us/products/1697713>

Shielded	no
Cable type	PVC gray [500]
	PVC gray 500
Conductor type	Assembled shielded round cable
Conductor structure signal line	14x 0.15 mm
AWG signal line	24
Conductor cross-section	3x 0.25 mm ² (Signal line)
Wire diameter incl. insulation	1.17 mm ±0.05 mm
External cable diameter	4.20 mm ±0.15 mm
Outer sheath, material	PVC
External sheath, color	gray RAL 7001
Conductor material	Bare Cu litz wires
Material wire insulation	PVC
Single wire, color	brown, blue, black
Thickness, insulation	≥ 0.23 mm (Core insulation)
Thickness, outer sheath	≥ 0.76 mm
Overall twist	3 wires, twisted
Max. conductor resistance	max. 79 Ω/km (at 20 °C)
Insulation resistance	≥ 100 MΩ*km (at 20 °C)
Nominal voltage, cable	≥ 300 V
Test voltage	≤ 3000 V
Smallest bending radius, fixed installation	13 mm
Halogen-free	no
Flame resistance	As per UL-Style 2464
Resistance to oil	in accordance with DIN EN 60811-2-1
Ambient temperature (operation)	-40 °C ... 80 °C (cable, fixed installation)
	-25 °C ... 80 °C (Cable, flexible installation)

Gray, highly flexible PUR [800]

Note	Due to the extremely robust outer sheath, this cable should only be stripped in 5 cm increments.
Cable weight	24 kg/km
UL AWM Style	20549
Number of positions	3
Shielded	no
Cable type	Gray, highly flexible PUR [800]
	Gray, highly flexible PUR 800
Conductor structure signal line	32x 0.10 mm
AWG signal line	24
Conductor cross-section	3x 0.25 mm ² (Signal line)
Wire diameter incl. insulation	1.2 mm ±0.05 mm (Signal line)
External cable diameter	4.30 mm ±0.2 mm
Outer sheath, material	PUR
External sheath, color	gray RAL 7001

SAC-3P-M 8MS-M12FR-2L/.../... - Sensor/actuator cable



1697713

<https://www.phoenixcontact.com/us/products/1697713>

Conductor material	Bare Cu litz wires
Material wire insulation	PP
Single wire, color	brown, blue, black
Overall twist	3 wires, twisted
Max. conductor resistance	approx. 76 Ω/km
Insulation resistance	≥ 20 MΩ*km
Nominal voltage, cable	300 V
Test voltage	2000 V
Minimum bending radius, fixed installation	4 x D
Minimum bending radius, flexible installation	7.5 x D
Smallest bending radius, fixed installation	18 mm
Smallest bending radius, movable installation	33 mm
Dynamic load capacity (bending)	Max. bending cycles: 10000000, Bending radius: 7,5 x D, Traversing path: 5 m, Traversing rate: 3.3 m/s, Acceleration: 5 m/s ² Max. bending cycles: 15000000, Bending radius: 50 mm, Traversing path: 0.9 m, Traversing rate: 5 m/s, Acceleration: 30 m/s ²
Dynamic load capacity (torsion)	Torsion: ±360 °/m, Torsion cycles: 1000000, Torsional frequency: 35 cycles/min.
Halogen-free	in accordance with DIN VDE 0472 part 815
Flame resistance	in accordance with UL 758/1581 FT2
Resistance to oil	in accordance with DIN EN 60811-2-1
Other resistance	Highly resistant to acids, alkaline solutions and solvents Silicone-free
Special properties	Cable jacket is welding spark-resistant, recyclable, matt, low-adhesion, abrasion-resistant, flame-retardant, and self-extinguishing Free from silicone and cadmium Free of substances which would hinder coating with paint or varnish
Ambient temperature (operation)	-40 °C ... 80 °C (cable, fixed installation) -25 °C ... 80 °C (Cable, flexible installation)

Environmental and real-life conditions

Ambient conditions

Degree of protection	IP65 IP67 IP68
Ambient temperature (operation) (male connector/female connector)	-25 °C ... 90 °C (Plug / socket)

Standards and regulations

Standard designation	M12 connector
Standards/specifications	IEC 61076-2-101
Standard designation	M8 connector

SAC-3P-M 8MS-M12FR-2L/.../... - Sensor/actuator cable



1697713

<https://www.phoenixcontact.com/us/products/1697713>

Standards/specifications

IEC 61076-2-104

SAC-3P-M 8MS-M12FR-2L/.../... - Sensor/actuator cable

1697713

<https://www.phoenixcontact.com/us/products/1697713>

Drawings

Dimensional drawing

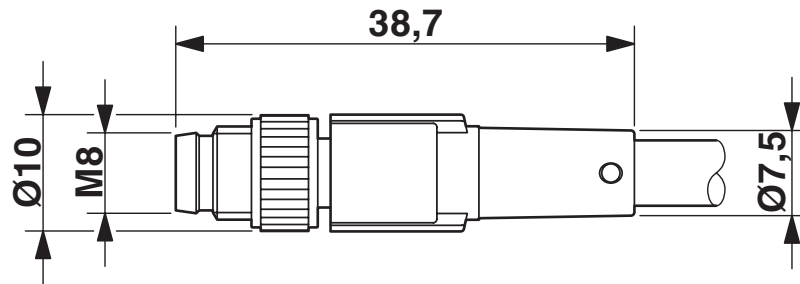

M8 x 1 male plug, straight version

Dimensional drawing

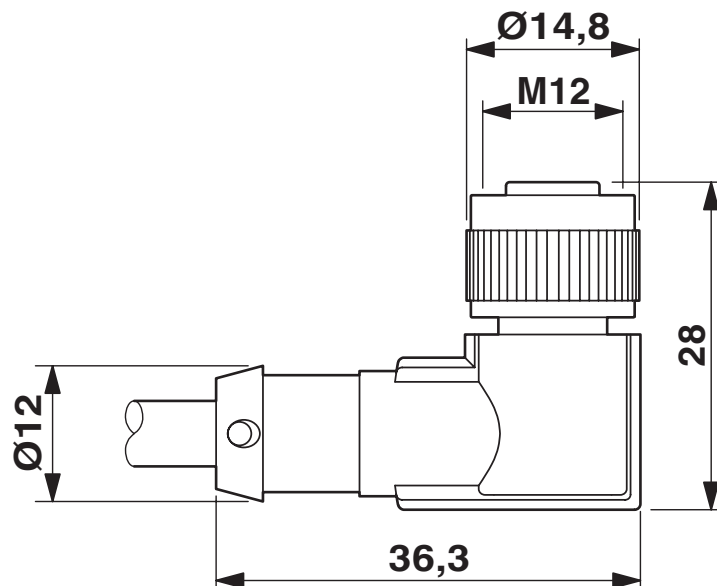

Socket M12 x 1, angled, with LED

SAC-3P-M 8MS-M12FR-2L/.../... - Sensor/actuator cable

1697713

<https://www.phoenixcontact.com/us/products/1697713>

Schematic diagram



Pin assignment M8 plug, 3-pos., view male side

Schematic diagram



Pin assignment M12 socket, 3-pos., A-coded, view female side

SAC-3P-M 8MS-M12FR-2L/.../... - Sensor/actuator cable

1697713

<https://www.phoenixcontact.com/us/products/1697713>

Circuit diagram

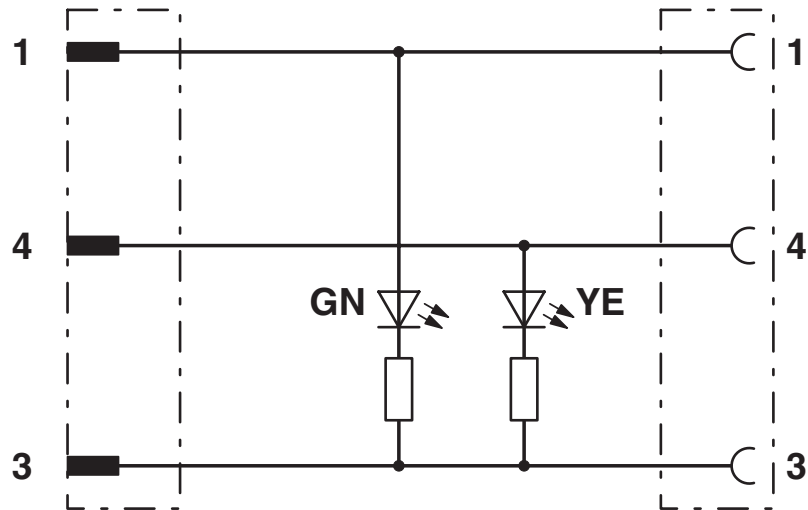

Contact assignment of M8 plugs / M12 sockets

SAC-3P-M 8MS-M12FR-2L/.../... - Sensor/actuator cable





1697713

<https://www.phoenixcontact.com/us/products/1697713>

Approvals

To download certificates, visit the product detail page: <https://www.phoenixcontact.com/us/products/1697713>

 UL Listed Approval ID: FILE E 221474				
	Nominal voltage U_N	Nominal current I_N	Cross section AWG	Cross section mm^2
keine				
	24 V	4 A	-	-

 cUL Listed Approval ID: FILE E 221474				
	Nominal voltage U_N	Nominal current I_N	Cross section AWG	Cross section mm^2
keine				
	24 V	4 A	-	-

 EAC-RoHS Approval ID: RU D-DE.HB35.B.00387	
--	--

SAC-3P-M 8MS-M12FR-2L/.../... - Sensor/actuator cable



1697713

<https://www.phoenixcontact.com/us/products/1697713>

Classifications

ECLASS

ECLASS-13.0	27060311
ECLASS-15.0	27060311

ETIM

ETIM 10.0	EC001855
-----------	----------

UNSPSC

UNSPSC 21.0	26121600
-------------	----------

SAC-3P-M 8MS-M12FR-2L/.../... - Sensor/actuator cable



1697713

<https://www.phoenixcontact.com/us/products/1697713>

Environmental product compliance

EU RoHS

Fulfills EU RoHS substance requirements	Yes, No exemptions
---	--------------------

China RoHS

Environment friendly use period (EFUP)	EFUP-E
	No hazardous substances above the limits

EU REACH SVHC

REACH candidate substance (CAS No.)	No substance above 0.1 wt%
-------------------------------------	----------------------------

Phoenix Contact 2026 © - all rights reserved
<https://www.phoenixcontact.com>

Phoenix Contact USA
586 Fulling Mill Road
Middletown, PA 17057, United States
(+717) 944-1300
info@phoenixcon.com