

RF-06M1N12WA00 - Device connector front mounting



1617486

<https://www.phoenixcontact.com/us/products/1617486>

Please be informed that the data shown in this PDF document is generated from our online catalog. Please find the complete data in the user documentation. Our general terms of use for downloads are valid.



Device connector front mounting, application: Signal, straight, Screw locking mechanism, M23, number of positions: 6, contact connection type: Pin, Axial O-ring, 4x Ø 3.2, shielded: yes, number of positions: 6, connection method: Solder connection, series: RF

The figure shows the 12-pos. product version with standard contact chamber numbering

Commercial data

Item number	1617486
Packing unit	20 pc
Minimum order quantity	20 pc
Note	Made to order (non-returnable)
Sales key	AB31
Product key	ABRAGL
GTIN	4046356603324
Weight per piece (including packing)	40.02 g
Weight per piece (excluding packing)	40.02 g
Customs tariff number	85366990
Country of origin	DE

1617486

<https://www.phoenixcontact.com/us/products/1617486>

Technical data

Product properties

Product type	Circular connectors (device side)
Series	RF
Application	Signal
Number of positions	6
Connection profile	6
Shielded	yes
Coding	N
Thread type	M23

Material specifications

Flammability rating according to UL 94	V0
Seal material	FPM

Electrical properties

Contact

Contact diameter	2 mm
Min. cross section	0.08 mm ²
Max. cross section	2.5 mm ²
Nominal current I _N	20 A
Nominal voltage U _N	48 V AC 74 V DC
Overvoltage category	III
Degree of pollution	3
Rated surge voltage	1.5 kV

Connection data

Conductor connection

Connection method	Solder connection
Contact connection type	Pin

Mechanical properties

Mechanical data

Insertion/withdrawal cycles	50
-----------------------------	----

Connector

Type	straight
Direction of rotation	Standard

Environmental and real-life conditions

RF-06M1N12WA00 - Device connector front mounting



1617486

<https://www.phoenixcontact.com/us/products/1617486>

Ambient conditions

Degree of protection	IP67
Ambient temperature (operation)	-40 °C ... 125 °C
Altitude	2000 m

Drawings

Dimensional drawing

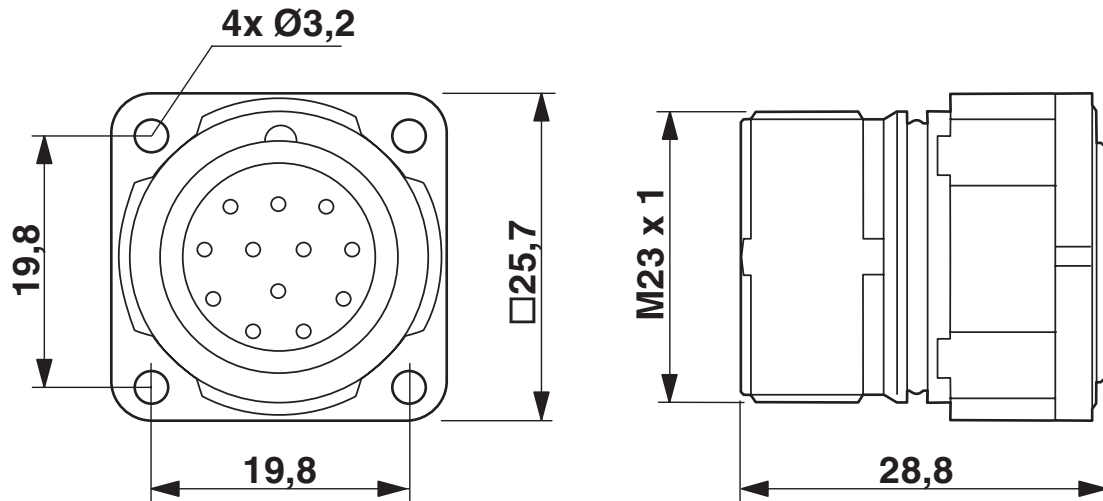

Dimensional drawing

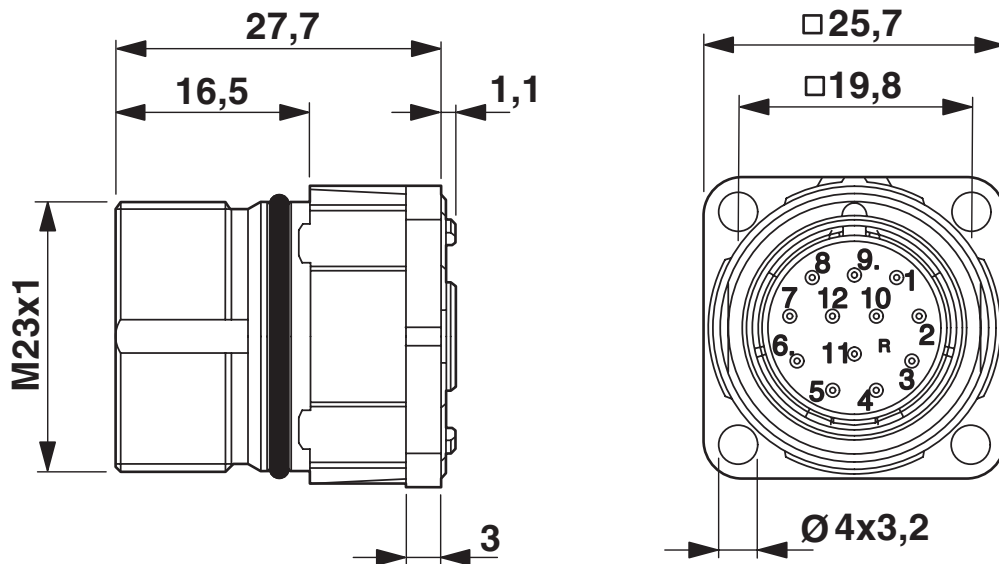

Schematic diagram



RF-06M1N12WA00 - Device connector front mounting



1617486

<https://www.phoenixcontact.com/us/products/1617486>

Classifications

UNSPSC

UNSPSC 21.0	39121413
-------------	----------

1617486

<https://www.phoenixcontact.com/us/products/1617486>

Environmental product compliance

EU RoHS

Fulfills EU RoHS substance requirements	Yes
Exemption	6(c)

China RoHS

Environment friendly use period (EFUP)	EFUP-50
	An article-related China RoHS declaration table can be found in the download area for the respective article under "Manufacturer declaration". For all articles with EFUP-E, no China RoHS declaration table issued and required.

EU REACH SVHC

REACH candidate substance (CAS No.)	Lead(CAS: 7439-92-1)
-------------------------------------	----------------------

Phoenix Contact 2026 © - all rights reserved
<https://www.phoenixcontact.com>

Phoenix Contact USA
586 Fulling Mill Road
Middletown, PA 17057, United States
(+717) 944-1300
info@phoenixcon.com