

SF-10KP350 - Crimp contact



1615963

<https://www.phoenixcontact.com/us/products/1615963>

Please be informed that the data shown in this PDF document is generated from our online catalog. Please find the complete data in the user documentation. Our general terms of use for downloads are valid.



Crimp contact, series: SF, Pin, rolled

Your advantages

- Crimping connection: vibration- and temperature-resistant assembly
- High tensile strength of the connection
- Low contact resistance
- Easy production monitoring
- Variable production run startup, thanks to full or semi-automation

Commercial data

Item number	1615963
Packing unit	1 pc
Note	Made to order (non-returnable)
Sales key	AB38
Product key	ABRECE
GTIN	4046356707695
Weight per piece (including packing)	1,000 g
Weight per piece (excluding packing)	1,000 g
Customs tariff number	85389099
Country of origin	DE

SF-10KP350 - Crimp contact



1615963

<https://www.phoenixcontact.com/us/products/1615963>

Technical data

Product properties

Product type	Crimp contact
Series	SF
Contact material type	rolled

Connection data

Connection technology

Contact connection type	Pin
-------------------------	-----

Mechanical properties

Mechanical data

Insertion/withdrawal cycles	500
-----------------------------	-----

SF-10KP350 - Crimp contact

1615963

<https://www.phoenixcontact.com/us/products/1615963>



Drawings

Dimensional drawing

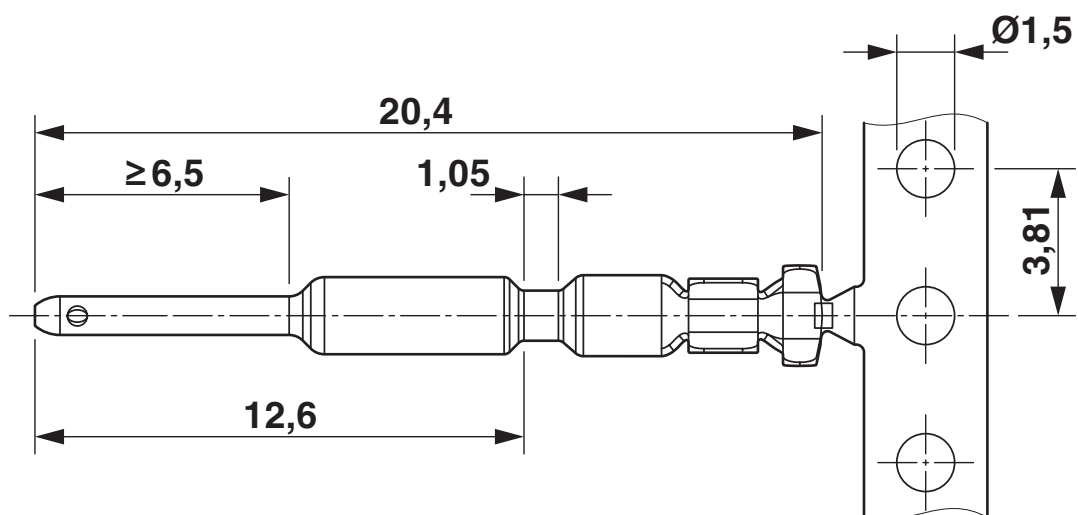

SF-10KP350 - Crimp contact



1615963

<https://www.phoenixcontact.com/us/products/1615963>

Environmental product compliance

EU RoHS

Fulfills EU RoHS substance requirements	Yes, No exemptions
---	--------------------

China RoHS

Environment friendly use period (EFUP)	EFUP-E
	No hazardous substances above the limits

EU REACH SVHC

REACH candidate substance (CAS No.)	No substance above 0.1 wt%
-------------------------------------	----------------------------

Phoenix Contact 2026 © - all rights reserved
<https://www.phoenixcontact.com>

Phoenix Contact USA
586 Fulling Mill Road
Middletown, PA 17057, United States
(+717) 944-1300
info@phoenixcon.com