

SAC-4P-M12MR-M 8FS/.../... - Sensor/actuator cable



1507874

<https://www.phoenixcontact.com/us/products/1507874>

Please be informed that the data shown in this PDF document is generated from our online catalog. Please find the complete data in the user documentation. Our general terms of use for downloads are valid.



Sensor/actuator cable, 4-position, Variable cable type, Plug angled M12, coding: A, on Socket straight M8, coding: A, cable length: Free input (0.2 ... 40.0 m)

Your advantages

- Easy and safe: 100 % electrically tested plug-in components

Commercial data

| | |
|------------------------|--------------------------------|
| Item number | 1507874 |
| Packing unit | 1 pc |
| Minimum order quantity | 1 pc |
| Note | Made to order (non-returnable) |
| Sales key | BF17 |
| Product key | AF1CCA |
| Customs tariff number | 85444290 |
| Country of origin | PL |

1507874

<https://www.phoenixcontact.com/us/products/1507874>

Technical data

Product properties

| | |
|----------------------|------------------------|
| Product type | Sensor/actuator cable |
| Application | Standard |
| | Robots and drag chains |
| Number of positions | 4 |
| No. of cable outlets | 1 |
| Shielded | no |
| Coding | A |

Insulation characteristics

| | |
|----------------------|----|
| Overvoltage category | II |
| Degree of pollution | 3 |

Material specifications

| | |
|--|---|
| Flammability rating according to UL 94 | HB |
| Seal material | NBR |
| Material of grip body | TPU, hardly inflammable, self-extinguishing |
| Contact material | CuSn |
| Contact surface material | Ni/Au |
| Contact carrier material | TPU GF |
| Material for screw connection | Zinc die-cast, nickel-plated |

Electrical properties

| | |
|-----------------------|----------------------------|
| Insulation resistance | $\geq 100 \text{ M}\Omega$ |
| Nominal voltage U_N | 48 V AC |
| | 60 V DC |
| Nominal current I_N | 4 A |

Mechanical properties

Mechanical data

| | |
|-----------------------------|------------|
| Insertion/withdrawal cycles | ≥ 100 |
|-----------------------------|------------|

Signaling

| | |
|------------------------|----|
| Status display | no |
| Status display present | no |

Connection data

Conductor connection

| | |
|-------------------|------------------------|
| Tightening torque | 0.4 Nm (M12 connector) |
| | 0.2 Nm (M8 connectors) |

SAC-4P-M12MR-M 8FS/.../... - Sensor/actuator cable



1507874

<https://www.phoenixcontact.com/us/products/1507874>

Connector

Connection 1

| | |
|---------------------|-----------------|
| Type | Plug angled M12 |
| Number of positions | 4 |
| Coding type | A |

Connection 2

| | |
|---------------------|--------------------|
| Type | Socket straight M8 |
| Number of positions | 4 |
| Coding type | A |

Cable/line

| | |
|--------------|-----------------------------|
| Cable length | Free input (0.2 ... 40.0 m) |
|--------------|-----------------------------|

PUR halogen-free black [PUR]

| | |
|---|---|
| Cable weight | 23 kg/km |
| UL AWM Style | 20549 / 10493 (80°C/300 V) |
| Number of positions | 4 |
| Shielded | no |
| Cable type | PUR halogen-free black [PUR] PUR halogen-free black PUR |
| Conductor structure signal line | 32x 0.10 mm |
| AWG signal line | 24 |
| Conductor cross-section | 4x 0.25 mm ² (Signal line) |
| Wire diameter incl. insulation | 1.17 mm ±0.02 mm (Signal line) |
| External cable diameter | 3.95 mm ±0.15 mm |
| Outer sheath, material | PUR |
| External sheath, color | black-gray RAL 7021 |
| Conductor material | Bare Cu litz wires |
| Material wire insulation | PP |
| Single wire, color | brown, white, blue, black |
| Thickness, insulation | ≥ 0.21 mm (Core insulation) approx. 0.50 mm (Outer cable sheath) |
| Overall twist | 4 wires, twisted |
| Max. conductor resistance | max. 78 Ω/km (at 20 °C) |
| Insulation resistance | ≥ 100 GΩ*km (at 20 °C) |
| Nominal voltage, cable | ≤ 300 V |
| Test voltage | ≥ 3000 V |
| Smallest bending radius, fixed installation | 20 mm |
| Smallest bending radius, movable installation | 40 mm |
| Dynamic load capacity (bending) | Max. bending cycles: 10000000, Bending radius: 44 mm, Traversing path: 10 m, Traversing rate: 3 m/s, Acceleration: 5 m/s ² |
| Dynamic load capacity (torsion) | Torsion: ±180 °/m, Torsion cycles: ≥5000000, Torsional |

SAC-4P-M12MR-M 8FS/.../... - Sensor/actuator cable



1507874

<https://www.phoenixcontact.com/us/products/1507874>

| | |
|---------------------------------|--|
| | frequency: 35 cycles/min. |
| Halogen-free | in accordance with DIN VDE 0472 part 815 |
| Flame resistance | in accordance with UL 758/1581 FT2 DIN EN 60332-2-2 (20 s) |
| Resistance to oil | in accordance with DIN EN 60811-2-1 |
| Other resistance | Highly resistant to acids, alkaline solutions and solvents hydrolysis and microbe resistant partly UV-resistant (in accordance with DIN EN ISO 4892-2-A) |
| Special properties | Flexible cable conduit capable Silicone-free Free of substances which would hinder coating with paint or varnish |
| Ambient temperature (operation) | -40 °C ... 80 °C (cable, fixed installation) -25 °C ... 80 °C (Cable, flexible installation) |

PUR halogen-free gray [280]

| | |
|---|--|
| Cable weight | 23 kg/km |
| UL AWM Style | 20549 / 10493 (80°C/300 V) |
| Number of positions | 4 |
| Shielded | no |
| Cable type | PUR halogen-free gray [280] PUR halogen-free gray 280 |
| Conductor structure signal line | 32x 0.10 mm |
| AWG signal line | 24 |
| Conductor cross-section | 4x 0.25 mm ² (Signal line) |
| Wire diameter incl. insulation | 1.17 mm ±0.02 mm (Signal line) |
| External cable diameter | 3.95 mm ±0.15 mm |
| Outer sheath, material | PUR |
| External sheath, color | gray RAL 7001 |
| Conductor material | Bare Cu litz wires |
| Material wire insulation | PP |
| Single wire, color | brown, white, blue, black |
| Thickness, insulation | ≥ 0.21 mm (Core insulation) approx. 0.50 mm (Outer cable sheath) |
| Overall twist | 4 wires, twisted |
| Max. conductor resistance | max. 78 Ω/km (at 20 °C) |
| Insulation resistance | ≥ 100 GΩ*km (at 20 °C) |
| Nominal voltage, cable | ≤ 300 V |
| Test voltage | ≥ 3000 V |
| Smallest bending radius, fixed installation | 20 mm |
| Smallest bending radius, movable installation | 40 mm |
| Dynamic load capacity (bending) | Max. bending cycles: 10000000, Bending radius: 44 mm, Traversing path: 10 m, Traversing rate: 3 m/s, Acceleration: 5 m/s ² |
| Halogen-free | in accordance with DIN VDE 0472 part 815 |

SAC-4P-M12MR-M 8FS/.../... - Sensor/actuator cable



1507874

<https://www.phoenixcontact.com/us/products/1507874>

| | |
|---------------------------------|---|
| Flame resistance | in accordance with UL 758/1581 FT2 |
| | DIN EN 60332-2-2 (20 s) |
| Resistance to oil | in accordance with DIN EN 60811-2-1 |
| Other resistance | Highly resistant to acids, alkaline solutions and solvents |
| | hydrolysis and microbe resistant |
| | partly UV-resistant (in accordance with DIN EN ISO 4892-2-A) |
| Special properties | Flexible cable conduit capable |
| | Silicone-free |
| | Free of substances which would hinder coating with paint or varnish |
| Ambient temperature (operation) | -40 °C ... 80 °C (cable, fixed installation) |
| | -25 °C ... 80 °C (Cable, flexible installation) |

PUR halogen-free yellow [240]

| | |
|---|---|
| Cable weight | 25 kg/km |
| UL AWM Style | 20549 |
| Number of positions | 4 |
| Shielded | no |
| Cable type | PUR halogen-free yellow [240] |
| | PUR halogen-free yellow 240 |
| Conductor structure signal line | 32x 0.10 mm |
| AWG signal line | 24 |
| Conductor cross-section | 4x 0.25 mm ² (Signal line) |
| Wire diameter incl. insulation | 1.17 mm ±0.02 mm |
| External cable diameter | 4.40 mm ±0.15 mm |
| Outer sheath, material | PUR |
| External sheath, color | yellow, similar to RAL 1021 |
| Conductor material | Bare Cu litz wires |
| Material wire insulation | PP |
| Single wire, color | brown, white, blue, black |
| Thickness, insulation | ≥ 0.21 mm |
| Thickness, outer sheath | approx. 0.75 mm |
| Overall twist | 4 wires, twisted |
| Length of twist, overall twist | 45 mm |
| Max. conductor resistance | 78 Ω/km (at 20 °C) |
| Insulation resistance | ≥ 1 GΩ*km (at 20 °C) |
| Nominal voltage, cable | ≤ 300 V AC |
| Test voltage | ≥ 3000 V AC (Spark test) |
| Minimum bending radius, fixed installation | 5 x D |
| Minimum bending radius, flexible installation | 10 x D |
| Smallest bending radius, fixed installation | 22 mm |
| Smallest bending radius, movable installation | 44 mm |
| Dynamic load capacity (bending) | Max. bending cycles: 10000000, Bending radius: 10 x D, Traversing path: 10 m, Traversing rate: 3 m/s, Acceleration: 10 m/s ² |

SAC-4P-M12MR-M 8FS/.../... - Sensor/actuator cable



1507874

<https://www.phoenixcontact.com/us/products/1507874>

| | |
|---------------------------------|--|
| Dynamic load capacity (torsion) | Torsion: ± 180 °/m, Torsion cycles: ≥ 5000000 , Torsional frequency: 35 cycles/min. |
| Halogen-free | in accordance with DIN VDE 0472 part 815 |
| | in accordance with EN 50267-2-1 |
| Flame resistance | in accordance with UL 758/1581 FT2 |
| Resistance to oil | According to DIN EN 60811-2-1, 168 h at 100°C |
| | according to UL 758, 168 h at 60 °C |
| Other resistance | hydrolysis and microbe resistant |
| | Resistant to salt water |
| | abrasion-resistant |
| | Low adhesion |
| Ambient temperature (operation) | -40 °C ... 80 °C (cable, fixed installation) |
| | -25 °C ... 80 °C (Cable, flexible installation) |

PUR halogen-free orange [180]

| | |
|---|--|
| Cable weight | 25 kg/km |
| UL AWM Style | 20549 |
| Number of positions | 4 |
| Shielded | no |
| Cable type | PUR halogen-free orange [180] |
| | PUR halogen-free orange 180 |
| Conductor structure signal line | 32x 0.10 mm |
| AWG signal line | 24 |
| Conductor cross-section | 4x 0.25 mm ² (Signal line) |
| Wire diameter incl. insulation | 1.17 mm \pm 0.02 mm (Signal line) |
| External cable diameter | 4.40 mm \pm 0.15 mm |
| Outer sheath, material | PUR |
| External sheath, color | orange RAL 2003 |
| Conductor material | Bare Cu litz wires |
| Material wire insulation | PP |
| Single wire, color | brown, white, blue, black |
| Thickness, insulation | ≥ 0.21 mm (Core insulation) |
| | 0.75 mm (Outer cable sheath) |
| Overall twist | 4 wires, twisted |
| Max. conductor resistance | max. 78 Ω /km (at 20 °C) |
| Insulation resistance | ≥ 10 G Ω *km (at 20 °C) |
| Nominal voltage, cable | ≤ 300 V |
| Test voltage | ≥ 3000 V |
| Smallest bending radius, fixed installation | 22 mm |
| Dynamic load capacity (bending) | Max. bending cycles: 10000000 |
| Dynamic load capacity (torsion) | Torsion: ± 180 °/m, Torsion cycles: ≥ 5000000 , Torsional frequency: 35 cycles/min. |
| Halogen-free | in accordance with DIN VDE 0472 part 815 |
| Flame resistance | in accordance with DIN UL-Style 20549 |
| Ambient temperature (operation) | -25 °C ... 80 °C (Cable) |

SAC-4P-M12MR-M 8FS/.../... - Sensor/actuator cable



1507874

<https://www.phoenixcontact.com/us/products/1507874>

PVC black [PVC]

| | |
|---|---|
| Cable weight | 33 kg/km |
| UL AWM Style | 2464 / 1729 (80°C/300 V) |
| Number of positions | 4 |
| Shielded | no |
| Cable type | PVC black [PVC] PVC black PVC |
| Conductor structure signal line | 14x 0.15 mm |
| AWG signal line | 24 |
| Conductor cross-section | 4x 0.25 mm ² (Signal line) |
| Wire diameter incl. insulation | 1.17 mm ±0.05 mm |
| External cable diameter | 4.40 mm ±0.15 mm |
| Outer sheath, material | PVC |
| External sheath, color | black RAL 9005 |
| Conductor material | Bare Cu litz wires |
| Material wire insulation | PVC |
| Single wire, color | brown, white, blue, black |
| Thickness, insulation | ≥ 0.23 mm (Core insulation) ≥ 0.76 mm (Outer cable sheath) |
| Overall twist | 4 wires, twisted |
| Max. conductor resistance | max. 79 Ω/km (at 20 °C) |
| Insulation resistance | ≥ 100 MΩ*km (at 20 °C) |
| Nominal voltage, cable | ≤ 300 V |
| Test voltage | ≥ 3000 V |
| Minimum bending radius, fixed installation | 5 x D |
| Smallest bending radius, fixed installation | 22 mm |
| Flame resistance | As per UL-Style 2464 |
| Resistance to oil | EN 60811-2-1 |
| Ambient temperature (operation) | -25 °C ... 80 °C (cable, fixed installation) -10 °C ... 80 °C (Cable, flexible installation) |

PVC gray [500]

| | |
|---------------------------------|---------------------------------------|
| Cable weight | 33 kg/km |
| Number of positions | 4 |
| Shielded | no |
| Cable type | PVC gray [500] PVC gray 500 |
| Conductor structure signal line | 14x 0.15 mm |
| AWG signal line | 24 |
| Conductor cross-section | 4x 0.25 mm ² (Signal line) |
| Wire diameter incl. insulation | 1.17 mm ±0.05 mm |
| External cable diameter | 4.40 mm ±0.15 mm |
| Outer sheath, material | PVC |
| External sheath, color | gray RAL 7001 |

SAC-4P-M12MR-M 8FS/.../... - Sensor/actuator cable



1507874

<https://www.phoenixcontact.com/us/products/1507874>

| | |
|---------------------------------|---|
| Conductor material | Bare Cu litz wires |
| Material wire insulation | PVC |
| Single wire, color | brown, white, blue, black, green-yellow |
| Thickness, insulation | ≥ 0.23 mm (Core insulation) ≥ 0.76 mm (Outer cable sheath) |
| Overall twist | 4 wires, twisted |
| Max. conductor resistance | max. 79 Ω/km (at 20 °C) |
| Insulation resistance | ≥ 100 MΩ*km (at 20 °C) |
| Nominal voltage, cable | ≤ 300 V |
| Test voltage | ≥ 3000 V |
| Flame resistance | As per UL-Style 2464 |
| Ambient temperature (operation) | -40 °C ... 80 °C (cable, fixed installation) -25 °C ... 80 °C (Cable, flexible installation) |

Gray, highly flexible PUR [800]

| | |
|---|--|
| Note | Due to the extremely robust outer sheath, this cable should only be stripped in 5 cm increments. |
| Cable weight | 27.1 kg/km |
| UL AWM Style | 20549 |
| Number of positions | 4 |
| Shielded | no |
| Cable type | Gray, highly flexible PUR [800] Gray, highly flexible PUR 800 |
| Conductor structure signal line | 32x 0.10 mm |
| AWG signal line | 24 |
| Conductor cross-section | 4x 0.25 mm ² (Signal line) |
| Wire diameter incl. insulation | 1.15 mm ±0.05 mm (Signal line) |
| External cable diameter | 4.50 mm ±0.2 mm |
| Outer sheath, material | PUR |
| External sheath, color | gray RAL 7001 |
| Conductor material | Bare Cu litz wires |
| Material wire insulation | PP |
| Single wire, color | brown, white, blue, black |
| Overall twist | 4 wires, twisted |
| Max. conductor resistance | approx. 76 Ω/km |
| Insulation resistance | ≥ 20 MΩ*km |
| Nominal voltage, cable | 300 V |
| Test voltage | 1200 V |
| Minimum bending radius, fixed installation | 4 x D |
| Minimum bending radius, flexible installation | 7.5 x D |
| Smallest bending radius, fixed installation | 18 mm |
| Smallest bending radius, movable installation | 34 mm |
| Dynamic load capacity (bending) | Max. bending cycles: 10000000, Bending radius: 7,5 x D, Traversing path: 5 m, Traversing rate: 3.3 m/s, Acceleration: 5 m/s ² |

SAC-4P-M12MR-M 8FS/.../... - Sensor/actuator cable



1507874

<https://www.phoenixcontact.com/us/products/1507874>

| | |
|---------------------------------|---|
| | Max. bending cycles: 15000000, Bending radius: 50 mm, Traversing path: 0.9 m, Traversing rate: 5 m/s, Acceleration: 30 m/s ² |
| Dynamic load capacity (torsion) | Torsion: ± 360 °/m, Torsion cycles: 1000000, Torsional frequency: 35 cycles/min. |
| Halogen-free | in accordance with DIN VDE 0472 part 815 |
| Flame resistance | in accordance with UL 758/1581 FT2 |
| Resistance to oil | in accordance with DIN EN 60811-2-1 |
| Other resistance | Highly resistant to acids, alkaline solutions and solvents Silicone-free |
| Special properties | Cable jacket is welding spark-resistant, recyclable, matt, low-adhesion, abrasion-resistant, flame-retardant, and self-extinguishing Free from silicone and cadmium Free of substances which would hinder coating with paint or varnish |
| Ambient temperature (operation) | -40 °C ... 80 °C (cable, fixed installation) -25 °C ... 80 °C (Cable, flexible installation) |

Environmental and real-life conditions

Ambient conditions

| | |
|---|----------------------------------|
| Degree of protection | IP65 IP67 IP68 |
| Ambient temperature (operation) (male connector/female connector) | -25 °C ... 90 °C (Plug / socket) |

Standards and regulations

| | |
|--------------------------|-----------------|
| Standard designation | M12 connector |
| Standards/specifications | IEC 61076-2-101 |
| Standard designation | M8 connector |
| Standards/specifications | IEC 61076-2-104 |

SAC-4P-M12MR-M 8FS/.../... - Sensor/actuator cable

1507874

<https://www.phoenixcontact.com/us/products/1507874>

Drawings

Dimensional drawing

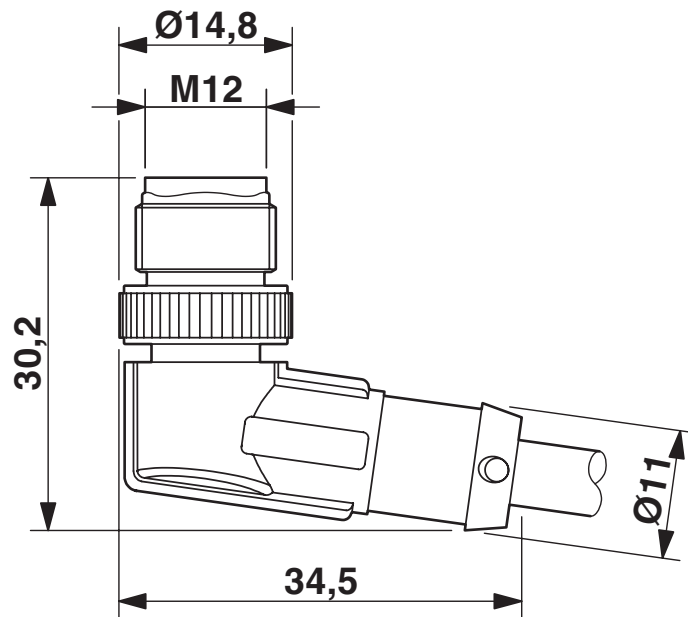

M12 x 1 male plug, angled

Dimensional drawing

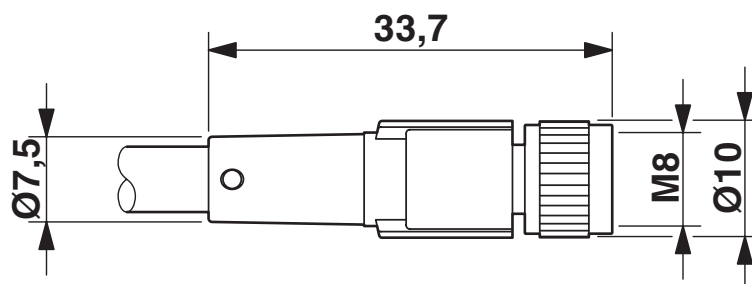

Socket M8 x 1, straight

Schematic diagram

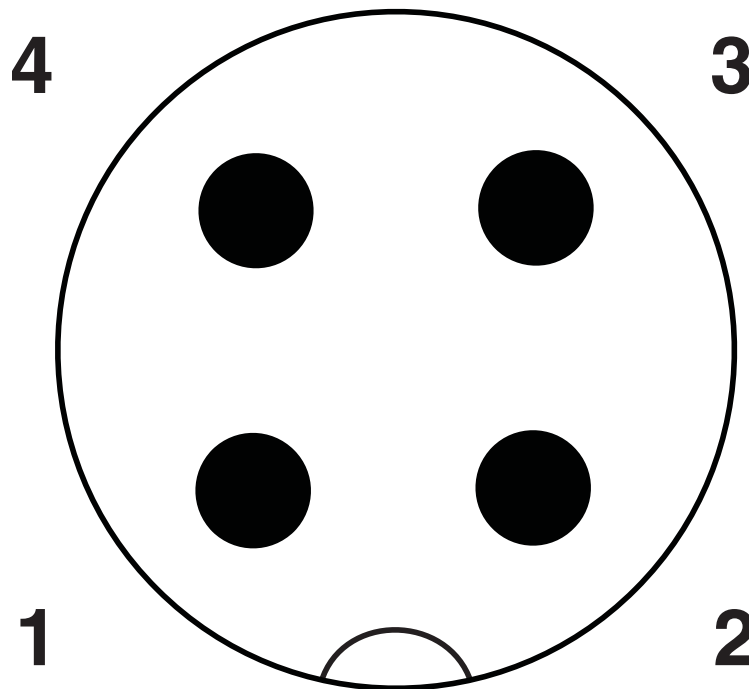

Pin assignment M12 plug, 4-pos., A-coded, view plug side

Schematic diagram

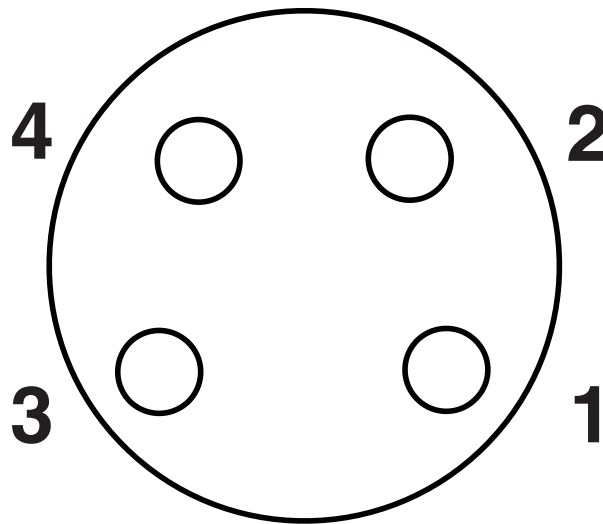

Pin assignment M8 socket, 4-pos., view female side

Circuit diagram

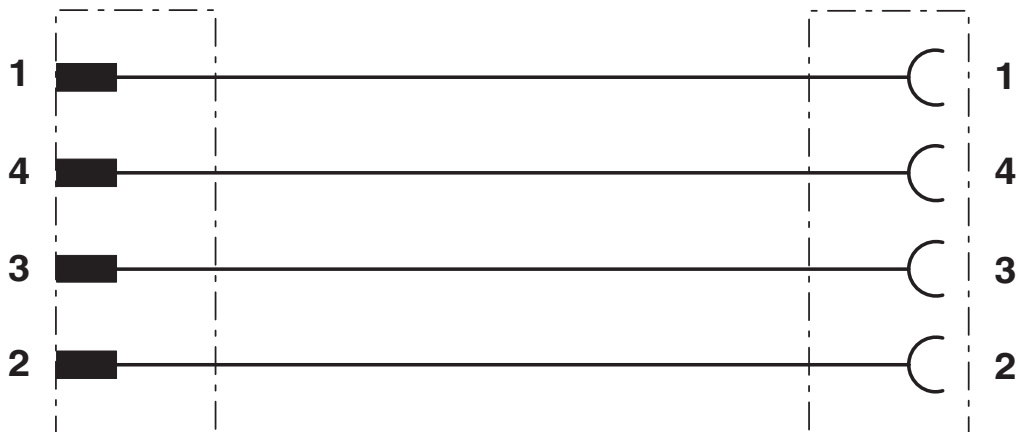

Contact assignment of M12 plugs / M8 sockets

SAC-4P-M12MR-M 8FS/.../... - Sensor/actuator cable





1507874

<https://www.phoenixcontact.com/us/products/1507874>

Approvals

To download certificates, visit the product detail page: <https://www.phoenixcontact.com/us/products/1507874>

|  UL Listed Approval ID: FILE E 221474 | | | | |
|--|-----------------------|-----------------------|-------------------|-----------------------------|
| | Nominal voltage U_N | Nominal current I_N | Cross section AWG | Cross section mm^2 |
| keine | | | | |
| | 30 V | 4 A | - | - |

|  cUL Listed Approval ID: FILE E 221474 | | | | |
|---|-----------------------|-----------------------|-------------------|-----------------------------|
| | Nominal voltage U_N | Nominal current I_N | Cross section AWG | Cross section mm^2 |
| keine | | | | |
| | 30 V | 4 A | - | - |

|  EAC-RoHS Approval ID: RU D-DE.HB35.B.00387 | |
|--|--|
|--|--|

SAC-4P-M12MR-M 8FS/.../... - Sensor/actuator cable



1507874

<https://www.phoenixcontact.com/us/products/1507874>

Classifications

ECLASS

| | |
|-------------|----------|
| ECLASS-13.0 | 27060311 |
| ECLASS-15.0 | 27060311 |

ETIM

| | |
|-----------|----------|
| ETIM 10.0 | EC001855 |
|-----------|----------|

UNSPSC

| | |
|-------------|----------|
| UNSPSC 21.0 | 26121600 |
|-------------|----------|

SAC-4P-M12MR-M 8FS/.../... - Sensor/actuator cable



1507874

<https://www.phoenixcontact.com/us/products/1507874>

Environmental product compliance

EU RoHS

| | |
|---|--------------------|
| Fulfills EU RoHS substance requirements | Yes, No exemptions |
|---|--------------------|

China RoHS

| | |
|--|--|
| Environment friendly use period (EFUP) | EFUP-E |
| | No hazardous substances above the limits |

EU REACH SVHC

| | |
|-------------------------------------|----------------------------|
| REACH candidate substance (CAS No.) | No substance above 0.1 wt% |
|-------------------------------------|----------------------------|

Phoenix Contact 2026 © - all rights reserved
<https://www.phoenixcontact.com>

Phoenix Contact USA
586 Fulling Mill Road
Middletown, PA 17057, United States
(+717) 944-1300
info@phoenixcon.com