

A-INL-PG36-P-LG - Counter nut

1424555

<https://www.phoenixcontact.com/us/products/1424555>

Please be informed that the data shown in this PDF document is generated from our online catalog. Please find the complete data in the user documentation. Our general terms of use for downloads are valid.

Counter nut, connecting thread: Pg36, color: light gray



Commercial data

Item number	1424555
Packing unit	5 pc
Minimum order quantity	1 pc
Sales key	BF68
Product key	AF7DZX
GTIN	4055626374598
Weight per piece (including packing)	12.7 g
Weight per piece (excluding packing)	12.4 g
Customs tariff number	39269097
Country of origin	TR

A-INL-PG36-P-LG - Counter nut

1424555

<https://www.phoenixcontact.com/us/products/1424555>

Technical data

Product properties

Product type	Flat nut
--------------	----------

Dimensions

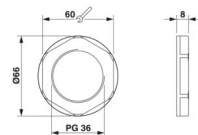
Dimensional drawing	
Length	8 mm
Diameter	47 mm
Connecting thread diameter	47 mm
Wrench size, counter nut	60 mm
Hexagon angular dimension	66 mm
Thread type connection side	Pg36

Material specifications

Material	PA 6.6 GF
Flammability rating according to UL 94	V2

Cable/line

Halogen-free	yes
--------------	-----

Environmental and real-life conditions

Ambient conditions

Ambient temperature (operation)	-40 °C ... 100 °C
---------------------------------	-------------------

A-INL-PG36-P-LG - Counter nut

1424555

<https://www.phoenixcontact.com/us/products/1424555>



Drawings

Dimensional drawing

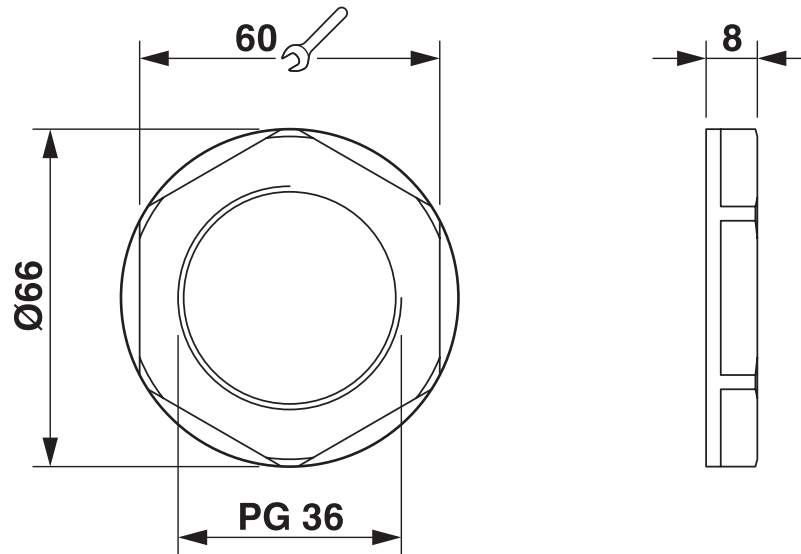

A-INL-PG36-P-LG - Counter nut



1424555

<https://www.phoenixcontact.com/us/products/1424555>

Classifications

ECLASS

ECLASS-13.0	27140807
ECLASS-15.0	27140807

ETIM

ETIM 10.0	EC003608
-----------	----------

UNSPSC

UNSPSC 21.0	31161700
-------------	----------

A-INL-PG36-P-LG - Counter nut



1424555

<https://www.phoenixcontact.com/us/products/1424555>

Environmental product compliance

EU RoHS

Fulfills EU RoHS substance requirements	Yes, No exemptions
---	--------------------

China RoHS

Environment friendly use period (EFUP)	EFUP-E
	No hazardous substances above the limits

EU REACH SVHC

REACH candidate substance (CAS No.)	No substance above 0.1 wt%
-------------------------------------	----------------------------

Phoenix Contact 2026 © - all rights reserved
<https://www.phoenixcontact.com>

Phoenix Contact USA
586 Fulling Mill Road
Middletown, PA 17057, United States
(+717) 944-1300
info@phoenixcon.com