

HC-EVO-B06-SHWS-2SSM25-PLRBK - Housing



1421229

<https://www.phoenixcontact.com/us/products/1421229>

Please be informed that the data shown in this PDF document is generated from our online catalog. Please find the complete data in the user documentation. Our general terms of use for downloads are valid.



Surface mounting housing B6, with single locking latch, material: PA 6.6-FR, cable outlets: 2, lateral, 2x M25, height: 74 mm, cable gland: none, Standard, including 2x reducing adapter

Your advantages

- Lower costs than metal version
- Low weight
- Lower risk of condensation

Commercial data

Item number	1421229
Packing unit	1 pc
Minimum order quantity	1 pc
Sales key	BF57
Product key	AF7APL
GTIN	4055626264387
Weight per piece (including packing)	147.3 g
Weight per piece (excluding packing)	147.3 g
Customs tariff number	85389099
Country of origin	PL

Technical data

Product properties

Product type	Housing with locking latch
Housing type	Surface mounting housing
Product family	HC-EVO-B
Application	Standard
Type	B6
No. of cable outlets	2
Type of the screw connection	2x M25
Cable outlet	lateral
Pg screw connection	none

Dimensions

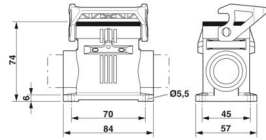
Dimensional drawing	
Width	57 mm
Height	74 mm
Length	84 mm
Hole diameter	5.5 mm

Material specifications

Flammability rating according to UL 94	V0 (Housing)
	V0 (Interlock)
Seal material	NBR
Housing material	PA 6.6-FR
Locking latch material	PA

Mechanical properties

Mechanical data

Type of the screw connection	2x M25
Locking type	Latch

Connection data

Tightening torque	2 Nm ... 3 Nm (for M5 mounting screws on the surface-mount housing)
-------------------	---

Mounting

Assembly note	Two plastic reductions M32 to M25 are provided
	One of the two openings for the screw connections is sealed but can be broken open using a screwdriver.

1421229

<https://www.phoenixcontact.com/us/products/1421229>

Environmental and real-life conditions

Ambient conditions

Degree of protection	IP66
Enclosure rating (NEMA)	12 (UL 50e)
Impact strength	IK08
Ambient temperature (operation)	-40 °C ... 125 °C

HC-EVO-B06-SHWS-2SSM25-PLRBK - Housing



1421229

<https://www.phoenixcontact.com/us/products/1421229>

Drawings

Dimensional drawing

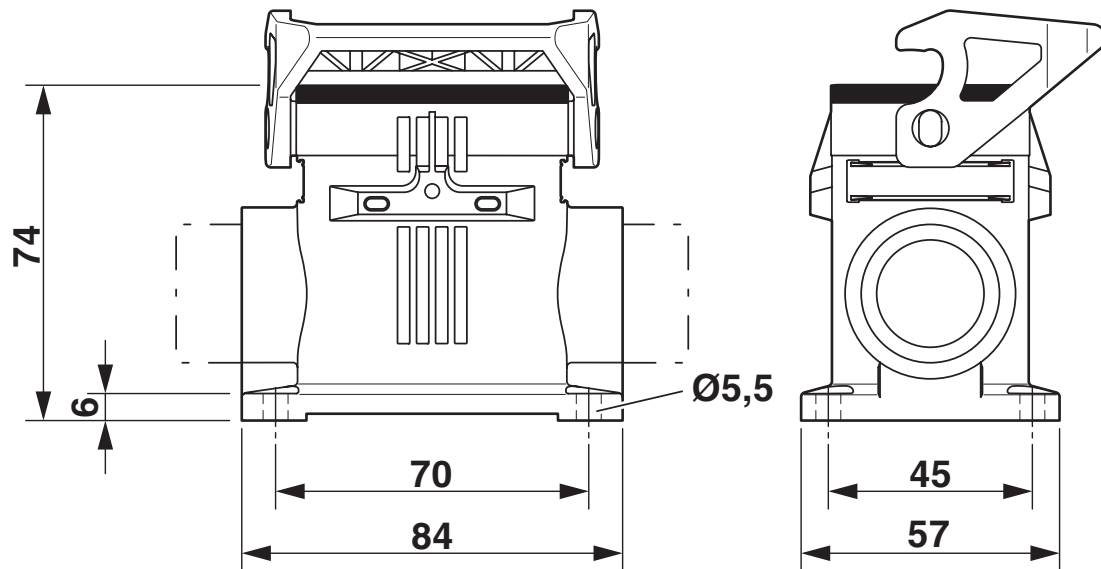

Dimensional drawing

1421229

<https://www.phoenixcontact.com/us/products/1421229>

Approvals

🔗 To download certificates, visit the product detail page: <https://www.phoenixcontact.com/us/products/1421229>

DNV

Approval ID: TAE000037S



cUL Recognized

Approval ID: E255026



UL Recognized

Approval ID: E255026



EAC

Approval ID: RU C-DE.AI30.B.01102

1421229

<https://www.phoenixcontact.com/us/products/1421229>

Classifications

ECLASS

ECLASS-13.0	27440202
ECLASS-15.0	27440202

ETIM

ETIM 10.0	EC000437
-----------	----------

UNSPSC

UNSPSC 21.0	31261500
-------------	----------

1421229

<https://www.phoenixcontact.com/us/products/1421229>

Environmental product compliance

EU RoHS

Fulfills EU RoHS substance requirements	Yes, No exemptions
---	--------------------

China RoHS

Environment friendly use period (EFUP)	EFUP-E
	No hazardous substances above the limits

EU REACH SVHC

REACH candidate substance (CAS No.)	No substance above 0.1 wt%
-------------------------------------	----------------------------

EF3.1 Climate Change

CO2e kg	1.148 kg CO2e
---------	---------------

Phoenix Contact 2026 © - all rights reserved
<https://www.phoenixcontact.com>

Phoenix Contact USA
586 Fulling Mill Road
Middletown, PA 17057, United States
(+717) 944-1300
info@phoenixcon.com