

HC-M-01-AT-F-40-PE - Contact insert module



1417380

<https://www.phoenixcontact.com/us/products/1417380>

Please be informed that the data shown in this PDF document is generated from our online catalog. Please find the complete data in the user documentation. Our general terms of use for downloads are valid.



Contact insert module, number of positions: PE, power contacts: 0, control contacts: 0, Socket, Axial screw connection, 25 mm² ... 70 mm², application: PE transmission

Commercial data

Item number	1417380
Packing unit	2 pc
Minimum order quantity	2 pc
Sales key	BF62
Product key	AF7ACE
GTIN	4055626112619
Weight per piece (including packing)	88.65 g
Weight per piece (excluding packing)	89.5 g
Customs tariff number	85366990
Country of origin	PL

Technical data

Notes

General	Contact insert module for HEAVYCON housing designs B6 to B48, housing height at least 72 mm
General	A HC-M-B...MFH... module carrier frame is required
General	Only operate the connector when there is no load and the power is switched off.
General	Install the contact insert in a housing with IP54 degree of protection or higher.
General	Strain relief is only ensured when installed into a HEAVYCON housing.

Mounting

Assembly note	To ensure correct use, installation in housing with IP54 protection or better is required
	<p>Note regarding axial connection technology:</p> <p>For flexible wires only. The specified conductor cross-sections refer to the geometric cross-section of the cable used. Use of cables with a geometric cross-section that differs greatly from the nominal cross-section of the cable should be checked before use.</p> <p>The wiring space for axial screw technology is designed for fine strand cables according to VDE 0295 Class 5. Deviating cable structures (e.g., Class 6 cables) should be checked before use.</p> <p>Assembly note</p> <p>Before assembly, ensure that the tapered screw is turned back all the way (chamber is open). Twisting the cables is not permitted. The wires must be inserted as far as they will go into the contact chamber (until the insulation touches the contact). Hold the wires in position and use the socket wrench to tighten. The used wire end should be cut off before connecting again. The connection screw may only be retightened once to prevent the litz wires from breaking. To prevent damage to the contact, the wire/cable must be mechanically supported at an appropriate distance from the connection point (e.g., when used in a sheet metal cut-out). DIN VDE 0100-520:2003-06 provides information on the correct way to do this. Unused connections must be tightened with maximum torque. Shrink the shrink sleeve over the connection point and the conductor. Temperature > 80°C.</p>
Hexagonal socket	SW 5

Product properties

Product type	Modular contact insert
Series	HC-M-HS
Application	PE transmission
Number of positions	1
Connection profile	PE
Number of module slots	2
No. of power contacts	0

HC-M-01-AT-F-40-PE - Contact insert module



1417380

<https://www.phoenixcontact.com/us/products/1417380>

No. of control contacts	0
-------------------------	---

Connection data

Connection technology	
Connection technology	Axial screw connection

Conductor connection	
Conductor cross-section	25 mm ² ... 70 mm ² (The cross section specification refers to the geometric cross section of the cable used)
Connection cross section AWG	10 ... 00
Tightening torque	0.5 Nm ... 1 Nm (Attaching the PE plate)
	8 Nm (25 mm ² ... 35 mm ²)
	9 Nm (50 mm ²)
	10 Nm (70 mm ²)
Stripping length of the individual wire	15 mm (with an outside conductor diameter up to 12 mm)
	19 mm (with an outside conductor diameter up to 16 mm)

Dimensions

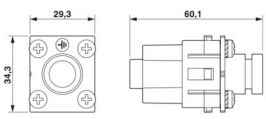
Dimensional drawing	
Width	34.2 mm
Height	54.3 mm
Length	29.4 mm

Mechanical characteristics	
Minimum housing height	72 mm
Contact diameter	9.5 mm

Electrical properties

SCCR	5 kA (UL 2237)
------	----------------

Mechanical properties

Mechanical data	
Insertion/withdrawal cycles	≥ 500

Material specifications

Flammability rating according to UL 94	V0
Contact material	Copper alloy
Contact surface material	Ag
Contact carrier material	PC
Standards/regulations	PC

HC-M-01-AT-F-40-PE - Contact insert module



1417380

<https://www.phoenixcontact.com/us/products/1417380>

Environmental and real-life conditions

Ambient conditions

Ambient temperature (operation)	-40 °C ... 125 °C
---------------------------------	-------------------

Standards and regulations

Testing

Standards/regulations	PC: Fire protection in rail vehicles - requirement sets R22, R23, and R24 acc. to DIN EN 45545-2 (Risk level HL1 - HL3)
-----------------------	---

HC-M-01-AT-F-40-PE - Contact insert module



1417380

<https://www.phoenixcontact.com/us/products/1417380>

Drawings

Dimensional drawing

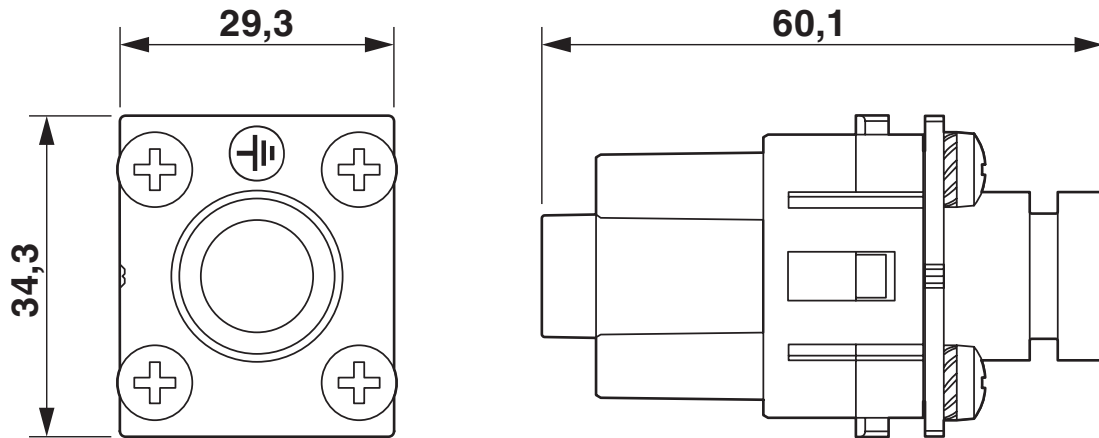

Female insert

Schematic diagram

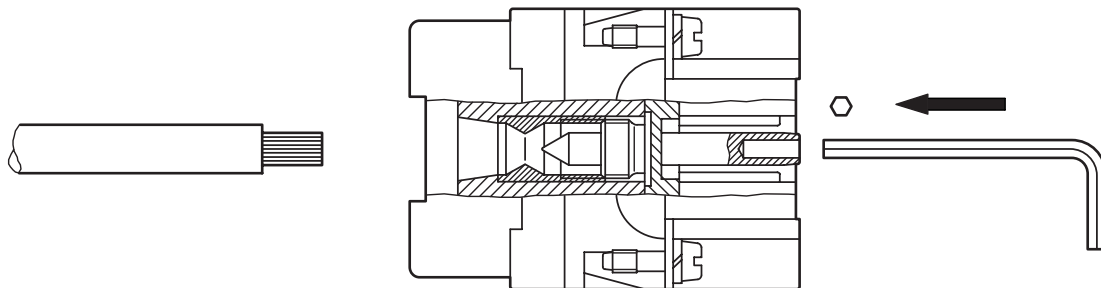

Axial screw connection

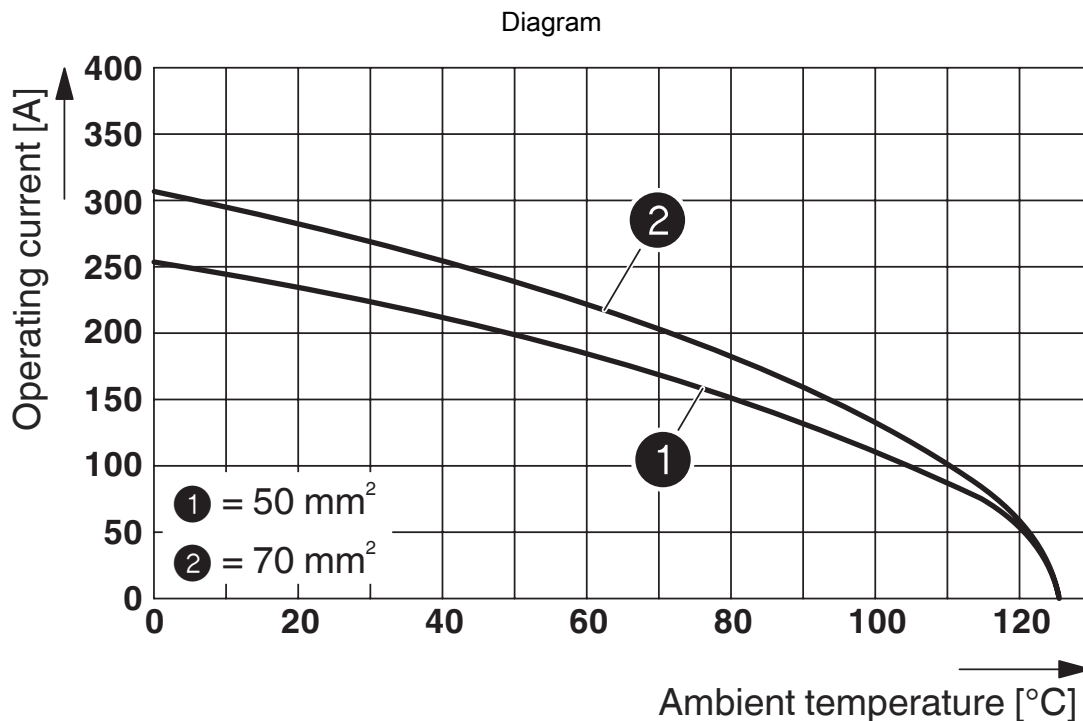

Three modules in B24 housing

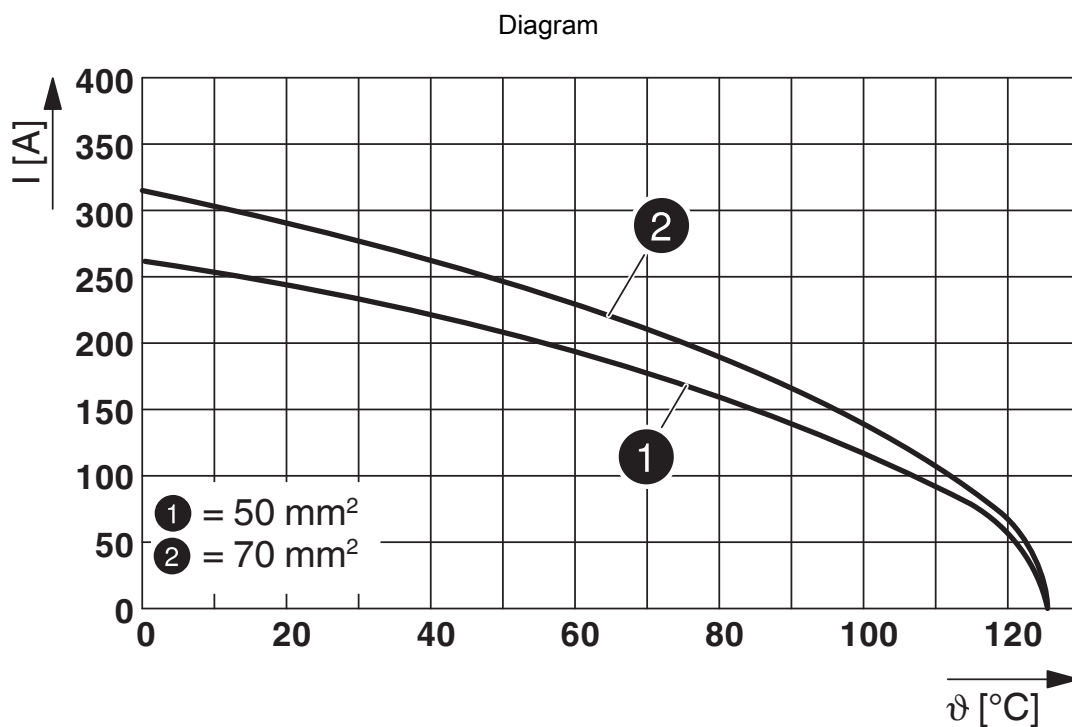

Two modules in B24 housing

HC-M-01-AT-F-40-PE - Contact insert module





1417380

<https://www.phoenixcontact.com/us/products/1417380>

Approvals

To download certificates, visit the product detail page: <https://www.phoenixcontact.com/us/products/1417380>

 UL Recognized Approval ID: E118976				
	Nominal voltage U_N	Nominal current I_N	Cross section AWG	Cross section mm^2
keine				
	600 V	-	- 00	-

 UL Recognized Approval ID: E468743				
	Nominal voltage U_N	Nominal current I_N	Cross section AWG	Cross section mm^2
keine				
	600 V	-	-	-

HC-M-01-AT-F-40-PE - Contact insert module



1417380

<https://www.phoenixcontact.com/us/products/1417380>

Classifications

ECLASS

ECLASS-13.0	27440217
ECLASS-15.0	27440217

ETIM

ETIM 10.0	EC000438
-----------	----------

UNSPSC

UNSPSC 21.0	39121400
-------------	----------

HC-M-01-AT-F-40-PE - Contact insert module



1417380

<https://www.phoenixcontact.com/us/products/1417380>

Environmental product compliance

EU RoHS

Fulfills EU RoHS substance requirements	Yes, No exemptions
---	--------------------

China RoHS

Environment friendly use period (EFUP)	EFUP-E
	No hazardous substances above the limits

EU REACH SVHC

REACH candidate substance (CAS No.)	No substance above 0.1 wt%
-------------------------------------	----------------------------

EF3.1 Climate Change

CO2e kg	2.266 kg CO2e
---------	---------------

Phoenix Contact 2026 © - all rights reserved
<https://www.phoenixcontact.com>

Phoenix Contact USA
586 Fulling Mill Road
Middletown, PA 17057, United States
(+717) 944-1300
info@phoenixcon.com