

SAC-5P-MINMS/15,0-U40/MINFS - Bus system cable



1416926

<https://www.phoenixcontact.com/us/products/1416926>

Please be informed that the data shown in this PDF document is generated from our online catalog. Please find the complete data in the user documentation. Our general terms of use for downloads are valid.



Bus system cable, DeviceNet™, 5-position, PVC, gray, shielded, Plug straight 7/8"-16UNF, coding: A, on Socket straight 7/8"-16UNF, coding: A, cable length: 15 m

Commercial data

Item number	1416926
Packing unit	1 pc
Minimum order quantity	1 pc
Note	Made to order (non-returnable)
Sales key	BF14
Product key	AF1IMD
GTIN	4055626219851
Weight per piece (including packing)	22.22 g
Weight per piece (excluding packing)	22.22 g
Customs tariff number	85444290
Country of origin	MX

SAC-5P-MINMS/15,0-U40/MINFS - Bus system cable



1416926

<https://www.phoenixcontact.com/us/products/1416926>

Technical data

Product properties

Product type	Sensor/actuator cable
Application	Standard
Sensor type	DeviceNet™
Number of positions	5
Shielded	yes
Coding	A

Material specifications

Flammability rating according to UL 94	V-0
Material of grip body	PVC
Contact material	CuZn
Contact surface material	Au
Contact carrier material	PVC
Material for screw connection	Anodized aluminum

Electrical properties

Insulation resistance	≥ 100 MΩ
Nominal voltage U _N	300 V AC/DC (UL rating)
	50 V AC/DC (IEC rating)
Nominal current I _N	8 A

Signaling

Status display	no
Status display present	no

Connection data

Conductor connection

Tightening torque	10 lb _F -in.
	1.12 Nm

Connection assignment

Contact Color (signal designation) Contact (optional)	1 (Plug) SR (shield) 1 (Socket)
	2 (Plug) RD (V+) 2 (Socket)
	3 (Plug) BK (V-) 3 (Socket)
	4 (Plug) WH (CAN_H) 4 (Socket)
	5 (Plug) BU (CAN_L) 5 (Socket)

Connector

Connection 1

Type	Plug straight 7/8"-16UNF
------	--------------------------

SAC-5P-MINMS/15,0-U40/MINFS - Bus system cable



1416926

<https://www.phoenixcontact.com/us/products/1416926>

Number of positions	5
Coding type	A

Connection 2

Type	Socket straight 7/8"-16UNF
Number of positions	5
Coding type	A

Cable/line

Cable length	15 m
--------------	------

DeviceNet trunk cable [U40]

Number of positions	5
Shielded	yes
Cable type	DeviceNet trunk cable [U40]
Conductor structure signal line	19 x AWG 30
Conductor structure, voltage supply	19 x AWG 28
Conductor cross-section	2 x AWG 18 data cable 2 x AWG 15 power supply 1 x AWG 18 drain wire
External cable diameter	11.43 mm
Outer sheath, material	PVC
External sheath, color	gray
Conductor material	Tin-plated Cu litz wires
Material wire insulation	Foamed PE PVC (Power supply)
Single wire, color	red-black, blue-white
Twisted pairs	2 cores to the pair
Type of pair shielding	Plastic-coated aluminum foil, aluminum side outside
Overall twist	2 pairs around a drain wire in the center to the core
Optical shield covering	65 %
Flame resistance	FT4
Resistance to oil	OIL RES I
Other resistance	UV resistant (720 h)
Ambient temperature (operation)	-20 °C ... 75 °C (cable, fixed installation) -5 °C ... 80 °C (Cable, flexible installation)

Environmental and real-life conditions

Ambient conditions

Degree of protection	IP68
Ambient temperature (operation) (male connector/female connector)	-20 °C ... 75 °C (Plug / socket)
Ambient temperature (operation) (Cable, fixed installation)	-20 °C ... 75 °C (cable, fixed installation)
Ambient temperature (operation) (Cable, flexible installation)	-5 °C ... 80 °C (Cable, flexible installation)

Drawings

Dimensional drawing



7/8"-16UNF plug, straight

Dimensional drawing



7/8"-16UNF socket, straight

Schematic diagram

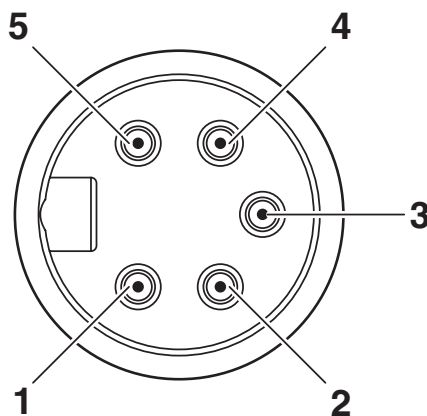

Pin assignment, plug, 7/8"-16UNF, 5-pos., view of male side

SAC-5P-MINMS/15,0-U40/MINFS - Bus system cable

1416926

<https://www.phoenixcontact.com/us/products/1416926>



Pin assignment, socket, 7/8"-16UNF, 5-pos., view of female side

Circuit diagram

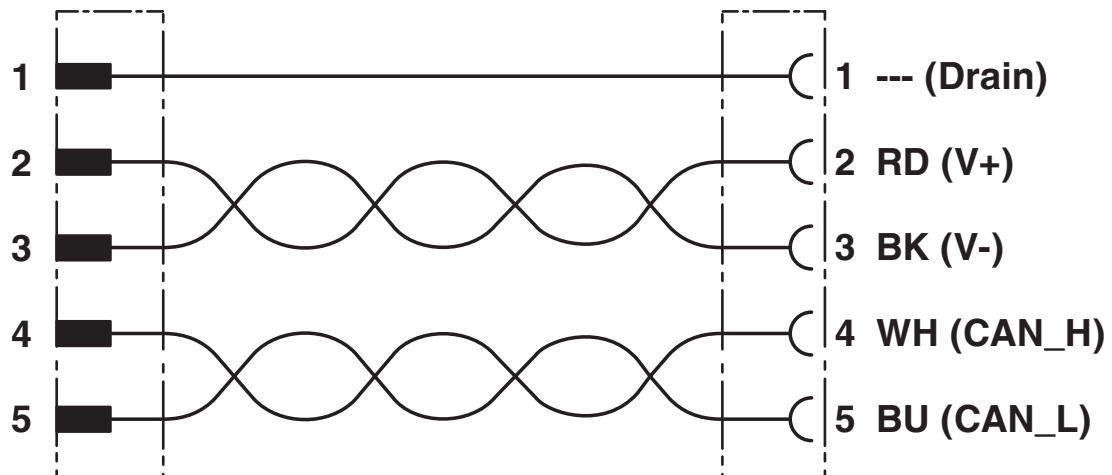

Contact assignment of 7/8" plugs/sockets

SAC-5P-MINMS/15,0-U40/MINFS - Bus system cable



1416926

<https://www.phoenixcontact.com/us/products/1416926>

Approvals

To download certificates, visit the product detail page: <https://www.phoenixcontact.com/us/products/1416926>



UL Listed

Approval ID: FILE E 221474



cUL Listed

Approval ID: FILE E 221474

SAC-5P-MINMS/15,0-U40/MINFS - Bus system cable



1416926

<https://www.phoenixcontact.com/us/products/1416926>

Classifications

ECLASS

ECLASS-13.0	27060307
ECLASS-15.0	27060307

ETIM

ETIM 10.0	EC001855
-----------	----------

UNSPSC

UNSPSC 21.0	31251501
-------------	----------

SAC-5P-MINMS/15,0-U40/MINFS - Bus system cable



1416926

<https://www.phoenixcontact.com/us/products/1416926>

Environmental product compliance

EU RoHS

Fulfills EU RoHS substance requirements	Yes, No exemptions
---	--------------------

China RoHS

Environment friendly use period (EFUP)	EFUP-E
	No hazardous substances above the limits

EU REACH SVHC

REACH candidate substance (CAS No.)	No substance above 0.1 wt%
-------------------------------------	----------------------------

Phoenix Contact 2026 © - all rights reserved
<https://www.phoenixcontact.com>

Phoenix Contact USA
586 Fulling Mill Road
Middletown, PA 17057, United States
(+717) 944-1300
info@phoenixcon.com