

HC-M-08-CT-M - Contact insert module



1414370

<https://www.phoenixcontact.com/us/products/1414370>

Please be informed that the data shown in this PDF document is generated from our online catalog. Please find the complete data in the user documentation. Our general terms of use for downloads are valid.



Contact insert module, number of positions: 8, power contacts: 8, control contacts: 0, Pin, Crimp connection, 320 V, 16 A, 0.5 mm² ... 4 mm², application: Power

Commercial data

Item number	1414370
Packing unit	5 pc
Minimum order quantity	1 pc
Sales key	BF62
Product key	AF7ACE
GTIN	4055626025230
Weight per piece (including packing)	8.8 g
Weight per piece (excluding packing)	8.55 g
Customs tariff number	85389099
Country of origin	PL

HC-M-08-CT-M - Contact insert module



1414370

<https://www.phoenixcontact.com/us/products/1414370>

Technical data

Notes

General	For HEAVYCON housing type B6 to B48, HC-M-B...MF-... hinged module carrier frame required, CK2,5-ED... imp contacts, crimp contacts not supplied as standard.
General	Connectors may be operated only when there is no load/voltage.

Mounting

Assembly note	To ensure correct use, installation in housing with IP54 protection or better is required
---------------	---

Product properties

Product type	Modular contact insert
Series	HC-M-08
Application	Power
Number of positions	8
Connection profile	8
Contact numbering	1 - 8
Number of module slots	1
No. of power contacts	8
No. of control contacts	0
Contact material type	turned

Insulation characteristics

Overvoltage category	III
Degree of pollution	3

Connection data

Connection technology

Connection technology	Crimp connection
-----------------------	------------------

Conductor connection

Conductor cross-section	0.5 mm ² ... 4 mm ²
Connection cross section AWG	20 ... 12
Stripping length of the individual wire	7.5 mm

Dimensions

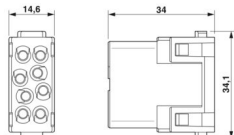
Dimensional drawing	
Width	34.2 mm
Height	34.5 mm

HC-M-08-CT-M - Contact insert module



1414370

<https://www.phoenixcontact.com/us/products/1414370>

Length	14.6 mm
--------	---------

Mechanical characteristics

Minimum housing height	52 mm
Contact diameter	2.5 mm

Electrical properties

Rated voltage (III/2) contacts	500 V
Rated voltage (III/3)	320 V
Rated surge voltage (III/2)	6 kV
Rated surge voltage (III/3)	4 kV
Rated surge voltage	4 kV
Rated current	16 A
SCCR	5 kA (UL 2237)

Mechanical properties

Mechanical data

Insertion/withdrawal cycles	≥ 500
-----------------------------	-------

Material specifications

Flammability rating according to UL 94	V0
Contact material	Copper alloy
Contact surface material	Ag (alternatively Au)
Contact carrier material	PC
Standards/regulations	PC

Environmental and real-life conditions

Ambient conditions

Ambient temperature (operation)	-40 °C ... 125 °C
---------------------------------	-------------------

Standards and regulations

Testing

Standards/regulations	PC: Fire protection in rail vehicles - requirement sets R22, R23, and R24 acc. to DIN EN 45545-2 (Risk level HL1 - HL3)
-----------------------	---

HC-M-08-CT-M - Contact insert module

1414370

<https://www.phoenixcontact.com/us/products/1414370>

Drawings

Dimensional drawing

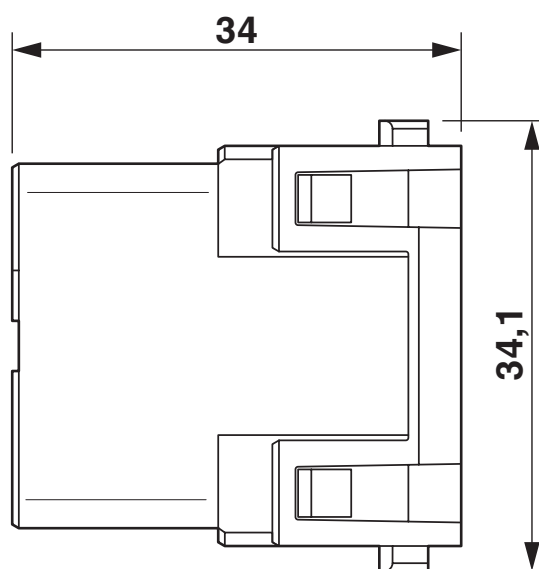
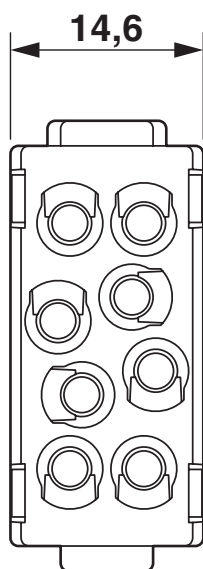

Male insert

HC-M-08-CT-M - Contact insert module

1414370

<https://www.phoenixcontact.com/us/products/1414370>



Schematic diagram

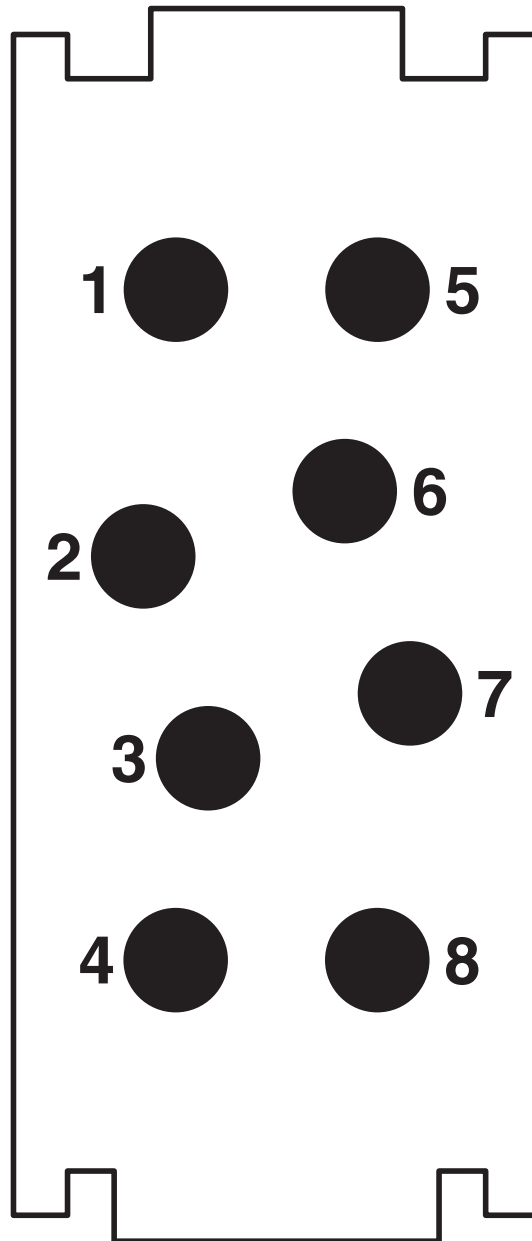

Connector pin assignment, connection side

HC-M-08-CT-M - Contact insert module



1414370

<https://www.phoenixcontact.com/us/products/1414370>

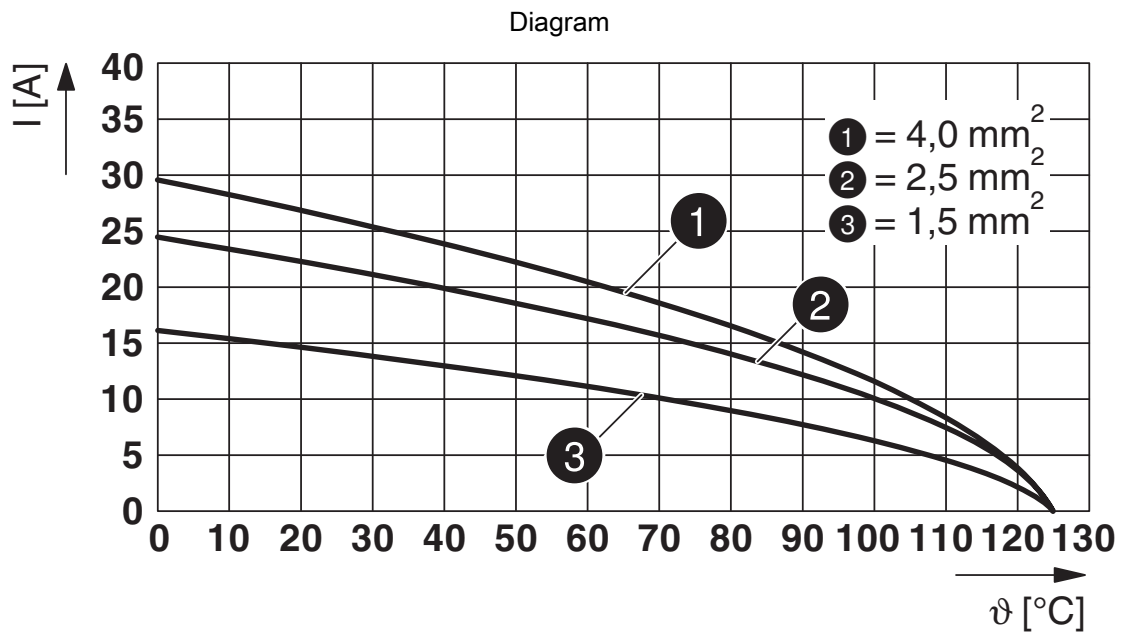

Derating diagram

HC-M-08-CT-M - Contact insert module



1414370

<https://www.phoenixcontact.com/us/products/1414370>

Approvals

To download certificates, visit the product detail page: <https://www.phoenixcontact.com/us/products/1414370>

 UL Recognized Approval ID: E468743				
	Nominal voltage U_N	Nominal current I_N	Cross section AWG	Cross section mm^2
keine				
	600 V	20 A	-	-

 CSA Approval ID: 158887				
	Nominal voltage U_N	Nominal current I_N	Cross section AWG	Cross section mm^2
keine				
	600 V	16 A	- 12	-

 UL Recognized Approval ID: E118976				
	Nominal voltage U_N	Nominal current I_N	Cross section AWG	Cross section mm^2
keine				
	600 V	20 A	-	-

DNV Approval ID: TAE000037S				
---------------------------------------	--	--	--	--

HC-M-08-CT-M - Contact insert module



1414370

<https://www.phoenixcontact.com/us/products/1414370>

Classifications

ECLASS

ECLASS-13.0	27440217
ECLASS-15.0	27440217

ETIM

ETIM 10.0	EC000438
-----------	----------

UNSPSC

UNSPSC 21.0	39121400
-------------	----------

HC-M-08-CT-M - Contact insert module



1414370

<https://www.phoenixcontact.com/us/products/1414370>

Environmental product compliance

EU RoHS

Fulfills EU RoHS substance requirements	Yes, No exemptions
---	--------------------

China RoHS

Environment friendly use period (EFUP)	EFUP-E
	No hazardous substances above the limits

EU REACH SVHC

REACH candidate substance (CAS No.)	No substance above 0.1 wt%
-------------------------------------	----------------------------

EF3.1 Climate Change

CO2e kg	0.047 kg CO2e
---------	---------------

Phoenix Contact 2026 © - all rights reserved
<https://www.phoenixcontact.com>

Phoenix Contact USA
586 Fulling Mill Road
Middletown, PA 17057, United States
(+717) 944-1300
info@phoenixcon.com