

HC-B10-SG-CBK - Flat gasket

1411484

<https://www.phoenixcontact.com/us/products/1411484>

Please be informed that the data shown in this PDF document is generated from our online catalog. Please find the complete data in the user documentation. Our general terms of use for downloads are valid.

Replacement flat gasket, for HEAVYCON panel mounting base, HC-STA....AL, type B10, conductive



Commercial data

Item number	1411484
Packing unit	10 pc
Minimum order quantity	10 pc
Sales key	BF66
Product key	AF7APZ
GTIN	4046356932844
Weight per piece (including packing)	5.58 g
Weight per piece (excluding packing)	5.05 g
Customs tariff number	40169300
Country of origin	CN

HC-B10-SG-CBK - Flat gasket

1411484

<https://www.phoenixcontact.com/us/products/1411484>

Technical data

Product properties

Product type	Seal
Application	for panel-mount base

Dimensions

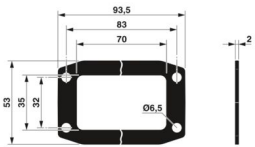
Dimensional drawing	
Width	53 mm
Height	2 mm
Length	93.5 mm
Drill hole distance, horizontal	83 mm
Drill hole distance, vertical	32 mm
Hole diameter	6.5 mm

Material specifications

Material	NBR, conductive
Seal material	NBR

Environmental and real-life conditions

Ambient conditions

Ambient temperature (operation)	-40 °C ... 125 °C
---------------------------------	-------------------

HC-B10-SG-CBK - Flat gasket

1411484

<https://www.phoenixcontact.com/us/products/1411484>



Drawings

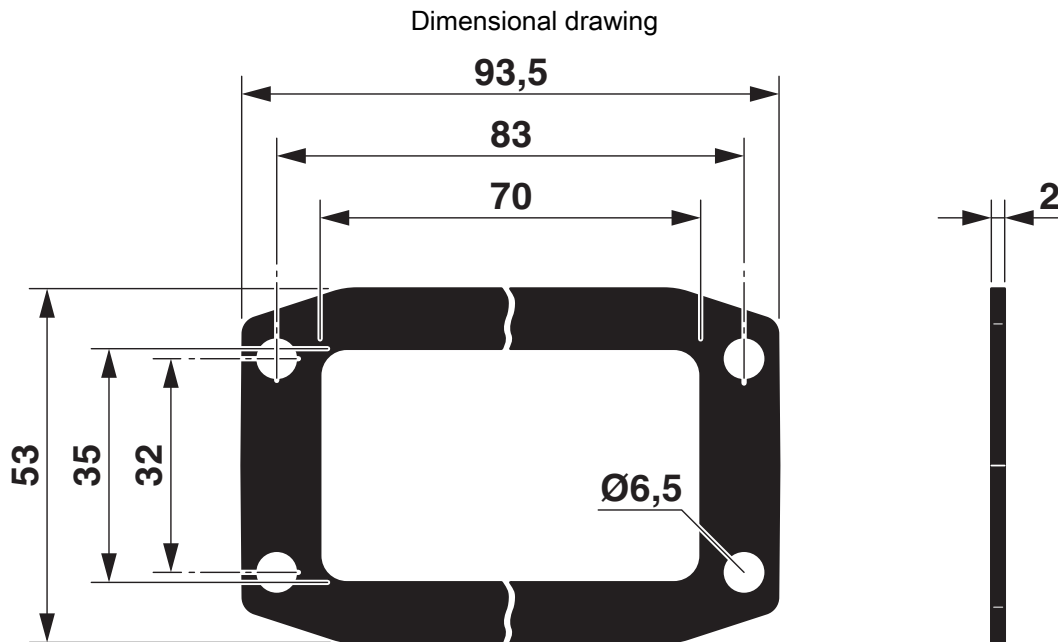

Dimensional drawing

HC-B10-SG-CBK - Flat gasket



1411484

<https://www.phoenixcontact.com/us/products/1411484>

Approvals

To download certificates, visit the product detail page: <https://www.phoenixcontact.com/us/products/1411484>



EAC

Approval ID: RU C-DE.AI30.B.01102

HC-B10-SG-CBK - Flat gasket



1411484

<https://www.phoenixcontact.com/us/products/1411484>

Classifications

ECLASS

ECLASS-13.0	23071590
ECLASS-15.0	27440292

ETIM

ETIM 10.0	EC002943
-----------	----------

UNSPSC

UNSPSC 21.0	31401600
-------------	----------

HC-B10-SG-CBK - Flat gasket



1411484

<https://www.phoenixcontact.com/us/products/1411484>

Environmental product compliance

EU RoHS

Fulfills EU RoHS substance requirements	Yes, No exemptions
---	--------------------

China RoHS

Environment friendly use period (EFUP)	EFUP-E
	No hazardous substances above the limits

EU REACH SVHC

REACH candidate substance (CAS No.)	No substance above 0.1 wt%
-------------------------------------	----------------------------

Phoenix Contact 2026 © - all rights reserved
<https://www.phoenixcontact.com>

Phoenix Contact USA
586 Fulling Mill Road
Middletown, PA 17057, United States
(+717) 944-1300
info@phoenixcon.com