

# HC-B06-SP-CBK - Profile gasket



1411477

<https://www.phoenixcontact.com/us/products/1411477>

Please be informed that the data shown in this PDF document is generated from our online catalog. Please find the complete data in the user documentation. Our general terms of use for downloads are valid.

Profile gasket for HEAVYCON EVO supporting base element type B6, conductive



## Commercial data

Item number	1411477
Packing unit	10 pc
Minimum order quantity	10 pc
Sales key	BF66
Product key	AF7APZ
GTIN	4046356932783
Weight per piece (including packing)	2.6 g
Weight per piece (excluding packing)	2.6 g
Customs tariff number	40169300
Country of origin	CN

# HC-B06-SP-CBK - Profile gasket



1411477

<https://www.phoenixcontact.com/us/products/1411477>

## Technical data

### Product properties

Product type	Seal
Application	for base housing

### Dimensions

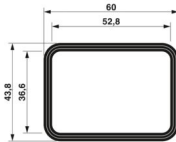
Dimensional drawing	
Width	43.8 mm
Height	3800 mm
Length	60 mm

### Material specifications

Material	NBR, conductive
Seal material	NBR

### Environmental and real-life conditions

#### Ambient conditions

Ambient temperature (operation)	-40 °C ... 125 °C
---------------------------------	-------------------

### Mounting

Assembly note	The replacement seal should be bonded with Loctite 454 adhesive.
	For HC-EVO-B6...AL housing and HC-STA-B6...AL

# HC-B06-SP-CBK - Profile gasket

1411477

<https://www.phoenixcontact.com/us/products/1411477>



## Drawings

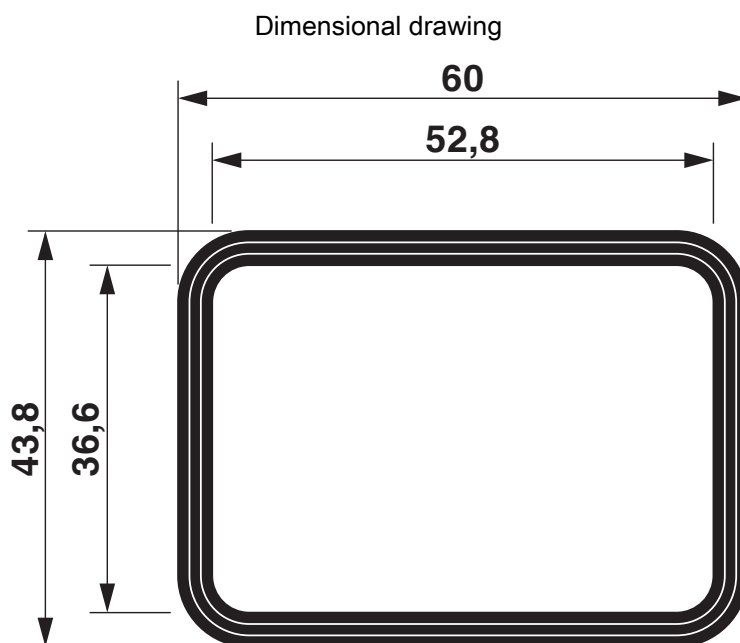

Dimensional drawing

# HC-B06-SP-CBK - Profile gasket



1411477

<https://www.phoenixcontact.com/us/products/1411477>

## Approvals

To download certificates, visit the product detail page: <https://www.phoenixcontact.com/us/products/1411477>



**EAC**

Approval ID: RU C-DE.AI30.B.01102

# HC-B06-SP-CBK - Profile gasket



1411477

<https://www.phoenixcontact.com/us/products/1411477>

## Classifications

### ECLASS

ECLASS-13.0	23071590
ECLASS-15.0	27440292

### ETIM

ETIM 10.0	EC002943
-----------	----------

### UNSPSC

UNSPSC 21.0	31401600
-------------	----------

# HC-B06-SP-CBK - Profile gasket



1411477

<https://www.phoenixcontact.com/us/products/1411477>

## Environmental product compliance

### EU RoHS

Fulfills EU RoHS substance requirements	Yes, No exemptions
---	--------------------

### China RoHS

Environment friendly use period (EFUP)	EFUP-E
	No hazardous substances above the limits

### EU REACH SVHC

REACH candidate substance (CAS No.)	No substance above 0.1 wt%
-------------------------------------	----------------------------

Phoenix Contact 2026 © - all rights reserved  
<https://www.phoenixcontact.com>

Phoenix Contact USA  
586 Fulling Mill Road  
Middletown, PA 17057, United States  
(+717) 944-1300  
[info@phoenixcon.com](mailto:info@phoenixcon.com)