

# CES-STPG-GY-2X9 - Cable sleeve



1410440

<https://www.phoenixcontact.com/us/products/1410440>

Please be informed that the data shown in this PDF document is generated from our online catalog. Please find the complete data in the user documentation. Our general terms of use for downloads are valid.



Cable sleeve, small, no. of conductors: 2, type: Round cable, slotted, external cable diameter: 2x 8.4 mm ... 8.7 mm, material: SEBS (halogen-free), color: gray, length: 29.5 mm, width: 19.5 mm, height: 17 mm

## Product description

Slotted cable sleeve

## Commercial data

Item number	1410440
Packing unit	10 pc
Minimum order quantity	1 pc
Sales key	BF67
Product key	AF7CCX
GTIN	4046356776271
Weight per piece (including packing)	6.07 g
Weight per piece (excluding packing)	6.07 g
Customs tariff number	40169997
Country of origin	PL

# CES-STPG-GY-2X9 - Cable sleeve

1410440

<https://www.phoenixcontact.com/us/products/1410440>

## Technical data

### Product properties

Product type	Cable sleeve
No. of conductors	2

### Dimensions

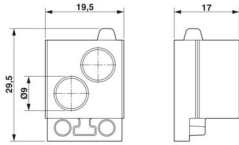
Dimensional drawing	
Width	19.5 mm
Height	17 mm
Length	29.5 mm

### Material specifications

Material	SEBS (halogen-free)
Flammability rating according to UL 94	V0

### Cable/line

External cable diameter	2x 8.4 mm ... 8.7 mm
-------------------------	----------------------

### Characteristics

Seal size	small
Design, Format	Round cable
Design, Cable seal	slotted

### Environmental and real-life conditions

#### Ambient conditions

Degree of protection	IP54
Ambient temperature (operation)	-40 °C ... 80 °C (static)

# CES-STPG-GY-2X9 - Cable sleeve



1410440

<https://www.phoenixcontact.com/us/products/1410440>

## Drawings

Dimensional drawing

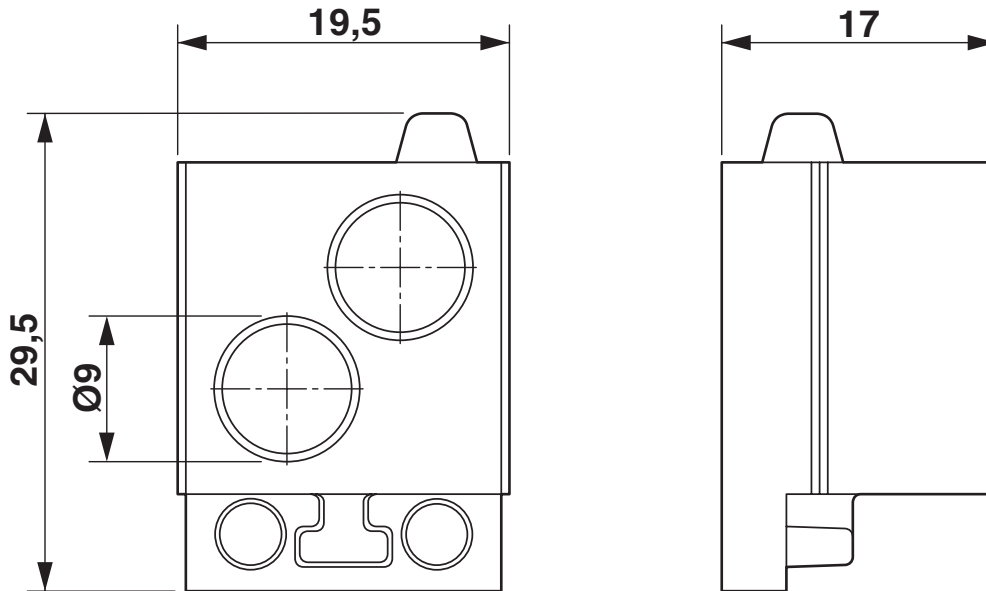

Dimensional drawing

# CES-STPG-GY-2X9 - Cable sleeve



1410440

<https://www.phoenixcontact.com/us/products/1410440>

## Approvals

To download certificates, visit the product detail page: <https://www.phoenixcontact.com/us/products/1410440>



**cUL Recognized**

Approval ID: E255026



**UL Recognized**

Approval ID: E255026

**DNV**

Approval ID: TAE00003VJ

# CES-STPG-GY-2X9 - Cable sleeve



1410440

<https://www.phoenixcontact.com/us/products/1410440>

## Classifications

### ECLASS

ECLASS-13.0	27144425
ECLASS-15.0	27144425

### ETIM

ETIM 10.0	EC000451
-----------	----------

### UNSPSC

UNSPSC 21.0	39121400
-------------	----------

# CES-STPG-GY-2X9 - Cable sleeve



1410440

<https://www.phoenixcontact.com/us/products/1410440>

## Environmental product compliance

### EU RoHS

Fulfills EU RoHS substance requirements	Yes, No exemptions
---	--------------------

### China RoHS

Environment friendly use period (EFUP)	EFUP-E
	No hazardous substances above the limits

### EU REACH SVHC

REACH candidate substance (CAS No.)	No substance above 0.1 wt%
-------------------------------------	----------------------------

### EF3.1 Climate Change

CO2e kg	0.073 kg CO2e
---------	---------------

Phoenix Contact 2026 © - all rights reserved  
<https://www.phoenixcontact.com>

Phoenix Contact USA  
586 Fulling Mill Road  
Middletown, PA 17057, United States  
(+717) 944-1300  
[info@phoenixcon.com](mailto:info@phoenixcon.com)