

# SAC-HZ-3P-M12MR/0,5-542/M12FRSH - Sensor/actuator cable



1409494

<https://www.phoenixcontact.com/us/products/1409494>

Please be informed that the data shown in this PDF document is generated from our online catalog. Please find the complete data in the user documentation. Our general terms of use for downloads are valid.

Sensor/actuator cable, 3-position, PVC, yellow, shielded, Plug angled M12, coding: A, on Socket angled M12, coding: A, cable length: 0.5 m



## Commercial data

Item number	1409494
Packing unit	1 pc
Minimum order quantity	1 pc
Note	Made to order (non-returnable)
Sales key	BF13
Product key	AF11GA
GTIN	4055626017389
Weight per piece (including packing)	22.22 g
Weight per piece (excluding packing)	22.22 g
Customs tariff number	85444290
Country of origin	US

# SAC-HZ-3P-M12MR/0,5-542/M12FRSH - Sensor/actuator cable



1409494

<https://www.phoenixcontact.com/us/products/1409494>

## Technical data

### Product properties

Product type	Sensor/actuator cable
Application	U.S. cables for hazardous locations
Number of positions	3
No. of cable outlets	1
Shielded	yes
Coding	A

### Insulation characteristics

Overvoltage category	II
Degree of pollution	3

### Material specifications

Material	TPE-U (Locking clip)
Flammability rating according to UL 94	HB
Seal material	NBR
Material of grip body	TPU, hardly inflammable, self-extinguishing
Contact material	CuSn
Contact surface material	Ni/Au
Contact carrier material	TPU GF
Material for screw connection	Zinc die-cast, nickel-plated
Outer sheath, material	PVC

### Electrical properties

Insulation resistance	$\geq 100 \text{ M}\Omega$
Nominal voltage $U_N$	48 V AC
	60 V DC
Nominal current $I_N$	4 A

### Mechanical properties

#### Mechanical data

Insertion/withdrawal cycles	$\geq 100$
-----------------------------	------------

### Signaling

Status display	no
Status display present	no

### Connection data

#### Conductor connection

Tightening torque	0.4 Nm (M12 connector)
-------------------	------------------------

# SAC-HZ-3P-M12MR/0,5-542/M12FRSH - Sensor/actuator cable

1409494

<https://www.phoenixcontact.com/us/products/1409494>

## Connector

### Connection 1

Type	Plug angled M12
Number of positions	3
Coding type	A

### Connection 2

Type	Socket angled M12
Number of positions	3
Coding type	A

## Cable/line

Cable length	0.5 m
--------------	-------

PVC yellow 105 °C [542]

Dimensional drawing	
Cable weight	40 kg/km
UL AWM Style	2517 (105 °C / 300 V)
Number of positions	3
Shielded	yes
Cable type	PVC yellow 105 °C [542]
Conductor structure signal line	7x 0.25 mm
AWG signal line	22
Wire diameter incl. insulation	1.27 mm ±0.03 mm
External cable diameter	5.20 mm ±0.2 mm
Outer sheath, material	PVC
External sheath, color	yellow
Conductor material	Tin-plated Cu litz wires
Material wire insulation	PVC
Single wire, color	brown, blue, black
Overall twist	3 wires, twisted
Optical shield covering	85 %
Max. conductor resistance	max. 50.5 Ω/km (20 °C)
Insulation resistance	≥ (550 M Ohms/m @ 500V)
Nominal voltage, cable	300 V

# SAC-HZ-3P-M12MR/0,5-542/M12FRSH - Sensor/actuator cable



1409494

<https://www.phoenixcontact.com/us/products/1409494>

Minimum bending radius, flexible installation	12 x D
Smallest bending radius, movable installation	63 mm
Flame resistance	FT4
Other resistance	UV resistant
Special properties	UL standards PLTC and ITC
Ambient temperature (operation)	-30 °C ... 105 °C (cable, fixed installation) -5 °C ... 105 °C (Cable, flexible installation)

## Environmental and real-life conditions

### Ambient conditions

Degree of protection	IP65 IP67 IP68
Ambient temperature (operation) (male connector/female connector)	-25 °C ... 90 °C (Plug / socket)
Ambient temperature (operation) (Locking clip)	-40 °C ... 65 °C (Locking clip)

## Approvals

### Conformity/Approvals

UL, USA / Canada	Class I, Div. 2, Groups A, B, C, D
------------------	------------------------------------

## Standards and regulations

Standard designation	M12 connector
Standards/specifications	IEC 61076-2-101

# SAC-HZ-3P-M12MR/0,5-542/M12FRSH - Sensor/actuator cable



1409494

<https://www.phoenixcontact.com/us/products/1409494>

## Drawings

Dimensional drawing

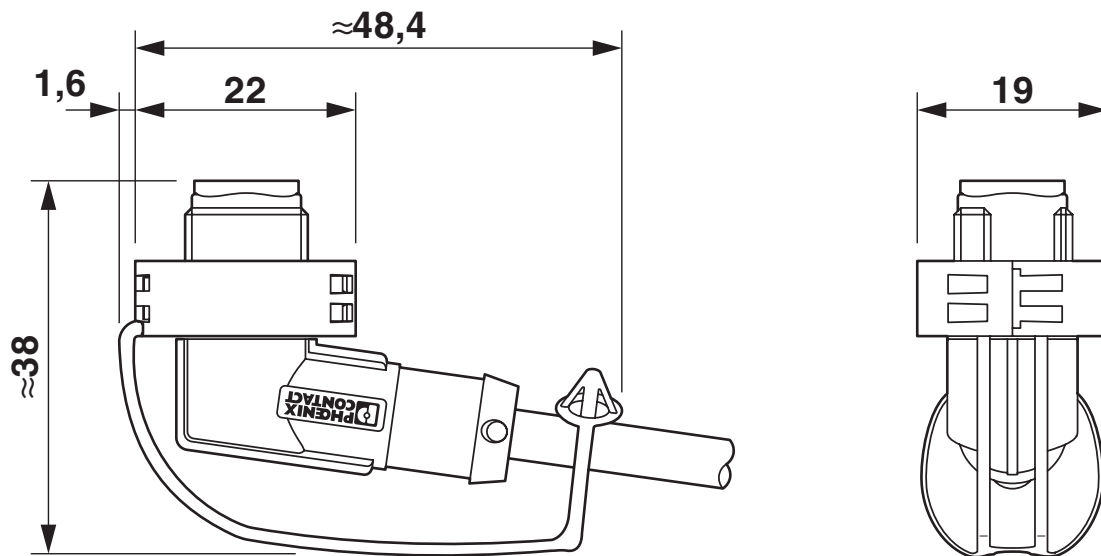

EXCLIP mounted plug

Dimensional drawing

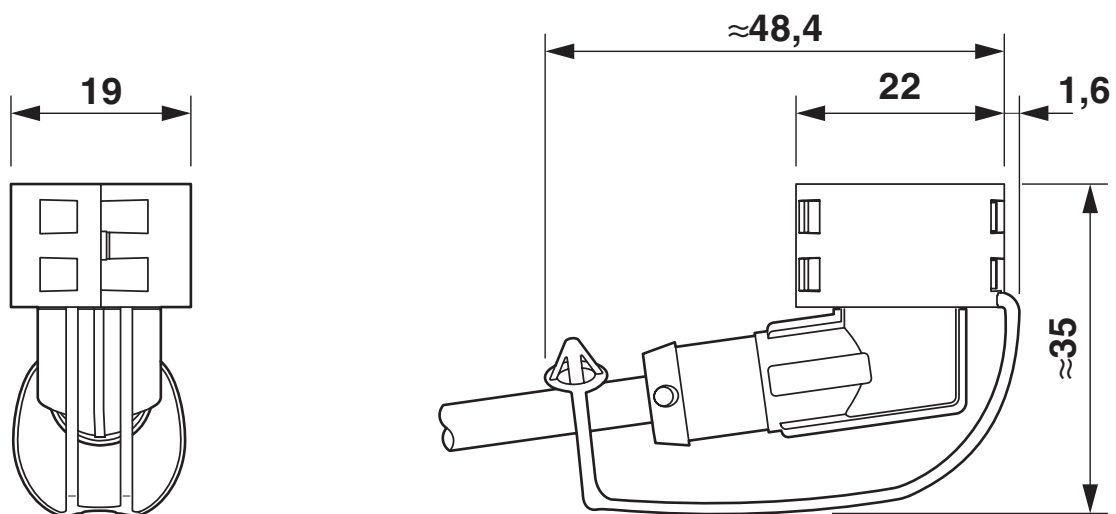

EXCLIP mounted socket

# SAC-HZ-3P-M12MR/0,5-542/M12FRSH - Sensor/actuator cable



1409494

<https://www.phoenixcontact.com/us/products/1409494>

Dimensional drawing



EXCLIP plug

# SAC-HZ-3P-M12MR/0,5-542/M12FRSH - Sensor/actuator cable



1409494

<https://www.phoenixcontact.com/us/products/1409494>

Dimensional drawing



EXCLIP socket

# SAC-HZ-3P-M12MR/0,5-542/M12FRSH - Sensor/actuator cable

1409494

<https://www.phoenixcontact.com/us/products/1409494>

Dimensional drawing



Plug, M12 x 1, angled, shielded

Dimensional drawing



M12 x 1 socket, angled, shielded

# SAC-HZ-3P-M12MR/0,5-542/M12FRSH - Sensor/actuator cable

1409494

<https://www.phoenixcontact.com/us/products/1409494>

Schematic diagram

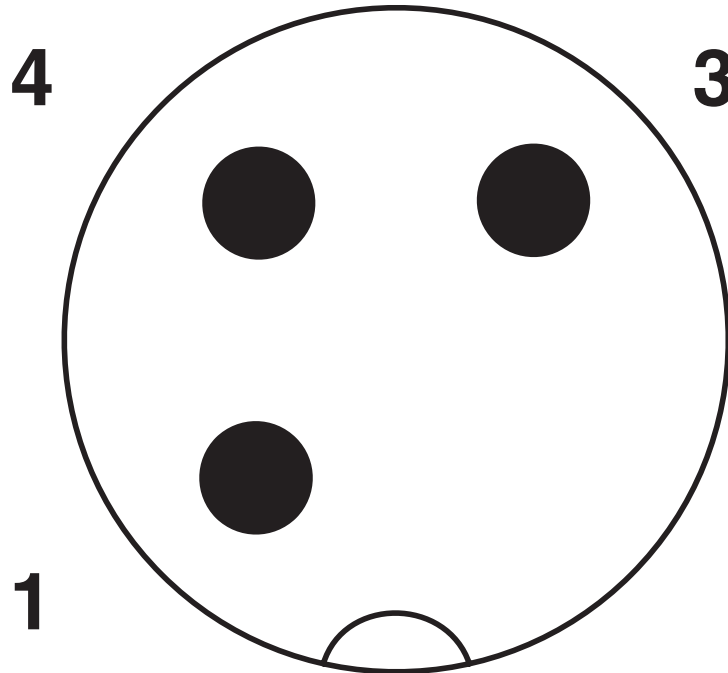

Pin assignment M12 plug, 3-pos., A-coded, view male side

Schematic diagram



Pin assignment M12 socket, 3-pos., A-coded, view female side

# SAC-HZ-3P-M12MR/0,5-542/M12FRSH - Sensor/actuator cable

1409494

<https://www.phoenixcontact.com/us/products/1409494>

Circuit diagram

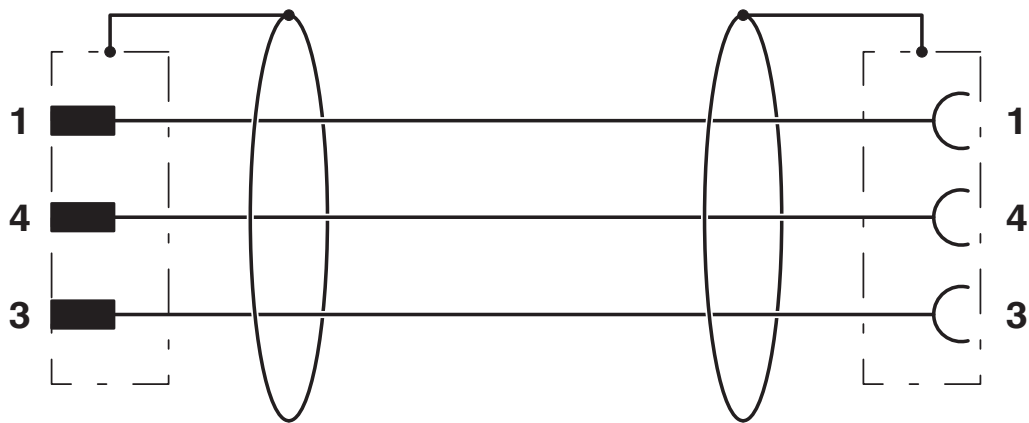

Contact assignment of the M12 plug and the M12 socket

# SAC-HZ-3P-M12MR/0,5-542/M12FRSH - Sensor/actuator cable



1409494

<https://www.phoenixcontact.com/us/products/1409494>

## Classifications

### ECLASS

ECLASS-13.0	27060311
ECLASS-15.0	27060311

### ETIM

ETIM 9.0	EC001855
----------	----------

### UNSPSC

UNSPSC 21.0	26121600
-------------	----------

# SAC-HZ-3P-M12MR/0,5-542/M12FRSH - Sensor/actuator cable



1409494

<https://www.phoenixcontact.com/us/products/1409494>

## Environmental product compliance

### China RoHS

Environment friendly use period (EFUP)	EFUP-E
	No hazardous substances above the limits

### EU REACH SVHC

REACH candidate substance (CAS No.)	No substance above 0.1 wt%
-------------------------------------	----------------------------

Phoenix Contact 2026 © - all rights reserved  
<https://www.phoenixcontact.com>

Phoenix Contact USA  
586 Fulling Mill Road  
Middletown, PA 17057, United States  
(+717) 944-1300  
[info@phoenixcon.com](mailto:info@phoenixcon.com)