

NS 35/15 PERF 755MM - DIN rail perforated



1207679

<https://www.phoenixcontact.com/us/products/1207679>

Please be informed that the data shown in this PDF document is generated from our online catalog. Please find the complete data in the user documentation. Our general terms of use for downloads are valid.



DIN rail perforated, similar to EN 60715, material: Steel, galvanized, passivated with a thick layer, Standard profile, color: silver

Commercial data

Item number	1207679
Packing unit	10 pc
Minimum order quantity	10 pc
Sales key	BE72
Product key	BE7244
GTIN	4017918932619
Weight per piece (including packing)	475 g
Weight per piece (excluding packing)	475 g
Customs tariff number	72166190
Country of origin	DE

NS 35/15 PERF 755MM - DIN rail perforated



1207679

<https://www.phoenixcontact.com/us/products/1207679>

Technical data

Product properties

Product type	DIN rail
--------------	----------

Dimensions

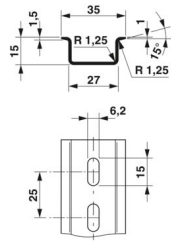
Dimensional drawing	
Width	35 mm
Hole width	15 mm
Hole height	6.2 mm
Depth	15 mm
Length	755 mm
Drill hole spacing	25 mm

Material specifications

Color	silver-colored
Material	Steel
Coating	galvanized, passivated with a thick layer

Standards and regulations

Connection in acc. with standard	IEC / EN
Tests	similar to EN 60715

Electrical tests

Short-time withstand current	
Equivalent E-Cu cross-section	25 mm ²
Short-time current resistance 1s	3 kA

NS 35/15 PERF 755MM - DIN rail perforated



1207679

<https://www.phoenixcontact.com/us/products/1207679>

Drawings

Dimensional drawing



NS 35/15 PERF 755MM - DIN rail perforated



1207679

<https://www.phoenixcontact.com/us/products/1207679>

Classifications

ECLASS

ECLASS-13.0	27400602
ECLASS-15.0	27400602

ETIM

ETIM 10.0	EC001285
-----------	----------

UNSPSC

UNSPSC 21.0	39121700
-------------	----------

NS 35/15 PERF 755MM - DIN rail perforated



1207679

<https://www.phoenixcontact.com/us/products/1207679>

Environmental product compliance

EU RoHS

Fulfills EU RoHS substance requirements	Yes, No exemptions
---	--------------------

China RoHS

Environment friendly use period (EFUP)	EFUP-E
	No hazardous substances above the limits

EU REACH SVHC

REACH candidate substance (CAS No.)	No substance above 0.1 wt%
-------------------------------------	----------------------------

EF3.1 Climate Change

CO2e kg	1.167 kg CO2e
---------	---------------

Phoenix Contact 2026 © - all rights reserved
<https://www.phoenixcontact.com>

Phoenix Contact USA
586 Fulling Mill Road
Middletown, PA 17057, United States
(+717) 944-1300
info@phoenixcon.com