

# FP 0,8/ 32-FH - SMD female connectors

1104542

<https://www.phoenixcontact.com/us/products/1104542>

Please be informed that the data shown in this PDF document is generated from our online catalog. Please find the complete data in the user documentation. Our general terms of use for downloads are valid.



SMD female connector, nominal current: 1.7 A, test voltage: 500 V AC, number of positions: 32, pitch: 0.8 mm, color: black, contact surface: Au, contact connection type: Socket, mounting: SMD soldering



## Your advantages

- Gold-plated contacts ensure transfer quality remains stable over the long term
- Reliable mechanical and electrical connections, thanks to the double-sided ScaleX contact system
- Robustness: ScaleX technology for high tolerance compensation and protection of contacts
- Flexible device design: various numbers of positions, designs, and stack heights with high wipe lengths



## Commercial data

Item number	1104542
Packing unit	400 pc
Minimum order quantity	400 pc
Sales key	AA23
Product key	AAWADA
GTIN	4063151000424
Weight per piece (including packing)	3.225 g
Weight per piece (excluding packing)	0.8 g
Customs tariff number	85366930
Country of origin	CZ

# FP 0,8/ 32-FH - SMD female connectors



1104542

<https://www.phoenixcontact.com/us/products/1104542>

## Technical data

### Product properties

Product type	SMD female connector
Product family	FP 0,8/...-FH
Number of positions	32
Pitch	0.8 mm
Number of rows	2
Pin layout	Linear pad geometry

### Electrical properties

#### Properties

Nominal current $I_N$	1.7 A IEC 60512-5-2:2002-02 (at 20°C 80-pos.)
Contact resistance	25 mΩ
Test voltage	500 V AC IEC 60512-4-1:2003-05

#### Data transmission

Data transmission rate	16 Gbps
------------------------	---------

### Mounting

Mounting type	SMD soldering
Pin layout	Linear pad geometry

#### Processing notes

Process	Reflow soldering
Moisture Sensitive Level	MSL 1
Classification temperature $T_C$	260 °C
Solder cycles in the reflow	3

### Material specifications

#### Material data - contact

Note	WEEE/RoHS-compliant, free of whiskers according to IEC 60068-2-82/JEDEC JESD 201
Contact material	Cu alloy
Surface characteristics	Selective coating
Metal surface contact area (top layer)	Gold (min. 0.5 μm Au)
Metal surface contact area (middle layer)	Nickel (1.27 μm - 4 μm Ni)
Metal surface soldering area (top layer)	Tin (2 μm - 6 μm Sn)
Metal surface soldering area (middle layer)	Nickel (1.27 μm - 4 μm Ni)

#### Material data - housing

Color (Housing)	black (9005)
Insulating material	LCP
Insulating material group	IIIb

# FP 0,8/ 32-FH - SMD female connectors



1104542

<https://www.phoenixcontact.com/us/products/1104542>

CTI according to IEC 60112	150
Flammability rating according to UL 94	V0

## Notes

Notes on operation	The permissible voltage during operation depends on the application, taking into consideration the air clearances and creepage distances within the scope of insulation requirements in accordance with IEC 60664-1.
Details for soldering processes	The items are suitable for assembly on both sides and for overhead soldering.

## Dimensions

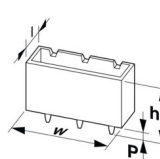
Dimensional drawing	
Pitch	0.8 mm
Width [w]	17.6 mm
Height [h]	7.9 mm
Length [l]	9.35 mm
Installed height	7.25 mm

## Application

Contact cover	0.8 mm
Center offset	± 0.7 mm in longitudinal and transverse direction
Wipe length	1.5 mm
Angular tolerance	± 5 ° in longitudinal and transverse direction (when plugging in) ± 5 ° in longitudinal and transverse direction (when plugged in)
Axial offset in X direction (longitudinal)	± 0.3 mm (Tolerance compensation when plugged in)
Axial offset in Y direction (transversal)	± 0.3 mm (Tolerance compensation when plugged in)

## PCB design

Pad geometry	0.5 x 1 mm
--------------	------------

## Electrical tests

### Thermal test | Test group C

Specification	IEC 60512-5-2:2002-02
Tested number of positions	80

### Insulation resistance

Specification	IEC 60512-3-1:2002-02
Insulation resistance, neighboring positions	≥ 5 GΩ

### Air clearances and creepage distances |

Insulating material group	IIIb
---------------------------	------

# FP 0,8/ 32-FH - SMD female connectors



1104542

<https://www.phoenixcontact.com/us/products/1104542>

Minimum value for clearance and creepage distance	0.25 mm
---	---------

## Environmental and real-life conditions

### Durability test

Specification	IEC 60512-9-1:2010-03 (following)
Contact resistance $R_1$	25 m $\Omega$
Contact resistance $R_2$	25 m $\Omega$
Insertion/withdrawal cycles	500

### Vibration test

Specification	IEC 60068-2-6:2007-12
Frequency	10 - 2000 - 10 Hz
Sweep speed	1 octave/min
Amplitude	1.5 mm (10 Hz ... 58 Hz)
Acceleration	200 m/s <sup>2</sup> (58 Hz ... 2000 Hz)
Test duration per axis	2.5 h
Test directions	X-, Y- and Z-axis

### Shocks

Specification	IEC 60068-2-27:2008-02
Pulse shape	Semi-sinusoidal
Acceleration	490 m/s <sup>2</sup>
Shock duration	11 ms
Test directions	X-, Y- and Z-axis (pos. and neg.)

### Railway application: Oscillation/broadband noise

Specification	DIN EN 50155 (VDE 0115-200):2022-06
	IEC 61373:2010-05
Spectrum	Long life test category 2, bogie-mounted
Frequency	$f_1 = 5$ Hz to $f_2 = 250$ Hz
ASD level	6.12 (m/s <sup>2</sup> ) <sup>2</sup> /Hz
Acceleration	30.6 m/s <sup>2</sup>
Test duration per axis	5 h
Test directions	X-, Y- and Z-axis
Contact interruption	< 1 $\mu$ s
Result	Test passed

### Railway application: Shocks

Specification	DIN EN 50155 (VDE 0115-200):2022-06
	IEC 61373:2010-05
Pulse shape	Semi-sinusoidal
Acceleration	490 m/s <sup>2</sup>
Shock duration	11 ms
Number of shocks per direction	3
Test directions	X-, Y- and Z-axis (pos. and neg.)

# FP 0,8/ 32-FH - SMD female connectors

1104542

<https://www.phoenixcontact.com/us/products/1104542>

Contact interruption	< 1 $\mu$ s
Result	Test passed

## Ambient conditions

Ambient temperature (storage/transport)	-40 °C ... 70 °C
Relative humidity (storage/transport)	30 % ... 70 %
Ambient temperature (assembly)	-5 °C ... 100 °C
Ambient temperature (operation)	-55 °C ... 125 °C

## Packaging specifications

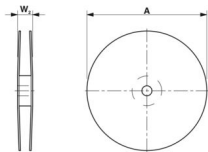
Dimensional drawing	
Type of packaging	32 mm wide tape
[W] tape width	32 mm
[W2] coil overall dimension	$\leq 38.4$ mm
[A] coil diameter	$\leq 330$ mm
Outer packaging type	Transparent-Bag

Drawings

Diagram



Type: FP 0,8/...-MH with FP 0,8/...-FH

# FP 0,8/ 32-FH - SMD female connectors



1104542

<https://www.phoenixcontact.com/us/products/1104542>

## Approvals

To download certificates, visit the product detail page: <https://www.phoenixcontact.com/us/products/1104542>



**cULus Recognized**

Approval ID: E118976-20190703

# FP 0,8/ 32-FH - SMD female connectors



1104542

<https://www.phoenixcontact.com/us/products/1104542>

## Classifications

### ECLASS

ECLASS-13.0	27460201
ECLASS-15.0	27460201

### ETIM

ETIM 10.0	EC002637
-----------	----------

### UNSPSC

UNSPSC 21.0	39121400
-------------	----------

# FP 0,8/ 32-FH - SMD female connectors



1104542

<https://www.phoenixcontact.com/us/products/1104542>

## Environmental product compliance

### EU RoHS

Fulfills EU RoHS substance requirements	Yes, No exemptions
---	--------------------

### China RoHS

Environment friendly use period (EFUP)	EFUP-E
	No hazardous substances above the limits

### EU REACH SVHC

REACH candidate substance (CAS No.)	No substance above 0.1 wt%
-------------------------------------	----------------------------

### EF3.1 Climate Change

CO2e kg	0.432 kg CO2e
---------	---------------

Phoenix Contact 2026 © - all rights reserved  
<https://www.phoenixcontact.com>

Phoenix Contact USA  
586 Fulling Mill Road  
Middletown, PA 17057, United States  
(+717) 944-1300  
[info@phoenixcon.com](mailto:info@phoenixcon.com)