

PTFIX 1,5-F - Flange

1049503

<https://www.phoenixcontact.com/us/products/1049503>

Please be informed that the data shown in this PDF document is generated from our online catalog. Please find the complete data in the user documentation. Our general terms of use for downloads are valid.



Flange, With screw fixing, for direct mounting of the 1.5 mm² FIX blocks, depth: 17.7 mm, width: 7.7 mm, height: 21.6 mm, color: gray, mounting type: Screw mounting

Your advantages

- Easy marking options

Commercial data

Item number	1049503
Packing unit	30 pc
Minimum order quantity	30 pc
Sales key	BE09
Product key	BEAZ11
GTIN	4055626661087
Weight per piece (including packing)	1.667 g
Weight per piece (excluding packing)	1.65 g
Customs tariff number	85369010
Country of origin	PL

PTFIX 1,5-F - Flange

1049503

<https://www.phoenixcontact.com/us/products/1049503>

Technical data

Product properties

Product type	Mounting material
--------------	-------------------

Connection data

Tightening torque	0.2 Nm
-------------------	--------

Dimensions

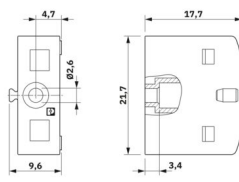
Dimensional drawing	
Width	7.7 mm
Height	21.6 mm
Depth	17.7 mm
Hole diameter	4.7 mm

Material specifications

Color	gray (RAL 7042)
Material	PA
Flammability rating according to UL 94	V0

Environmental and real-life conditions

Ambient conditions

Ambient temperature (operation)	-60 °C ... 110 °C (Operating temperature range incl. self-heating; for max. short-term operating temperature, see RTI Elec.)
Ambient temperature (storage/transport)	-25 °C ... 60 °C (for a short time, not exceeding 24 h, -60 °C to +70 °C)
Ambient temperature (assembly)	-5 °C ... 70 °C
Ambient temperature (actuation)	-5 °C ... 70 °C
Permissible humidity (operation)	20 % ... 90 %
Permissible humidity (storage/transport)	30 % ... 70 %

Mounting

Mounting type	Screw mounting
---------------	----------------

PTFIX 1,5-F - Flange

1049503

<https://www.phoenixcontact.com/us/products/1049503>



Drawings

Dimensional drawing

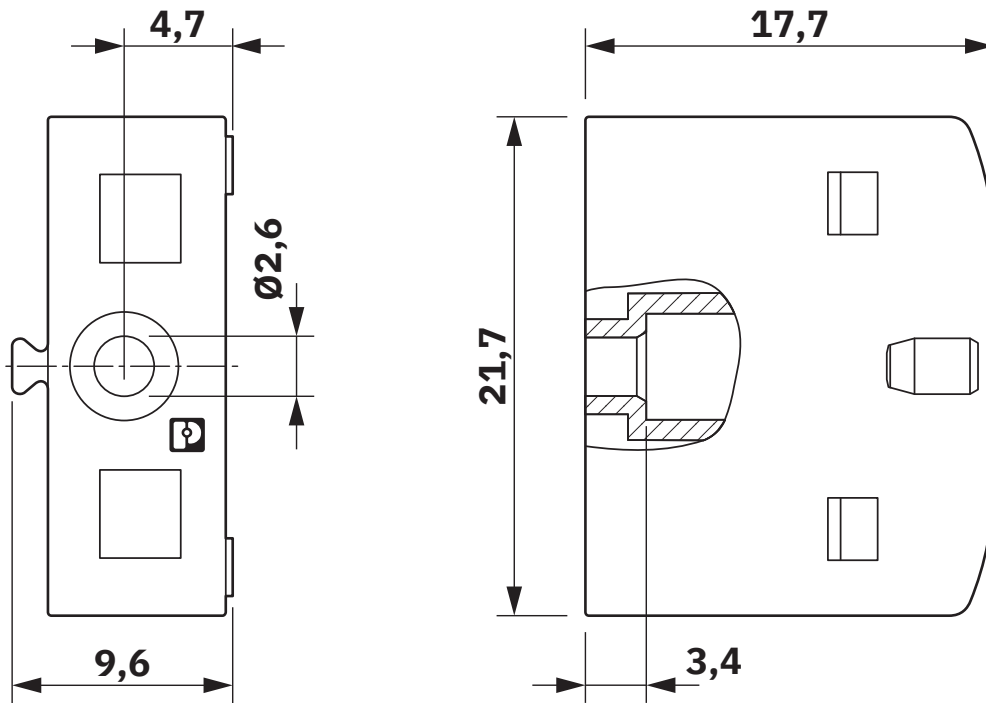

PTFIX 1,5-F - Flange

1049503

<https://www.phoenixcontact.com/us/products/1049503>



Approvals

To download certificates, visit the product detail page: <https://www.phoenixcontact.com/us/products/1049503>



EAC

Approval ID: KZ7500651131219505

PTFIX 1,5-F - Flange

1049503

<https://www.phoenixcontact.com/us/products/1049503>



Classifications

ECLASS

ECLASS-13.0	27250302
ECLASS-15.0	27250302

ETIM

ETIM 10.0	EC001041
-----------	----------

UNSPSC

UNSPSC 21.0	39121400
-------------	----------

PTFIX 1,5-F - Flange



1049503

<https://www.phoenixcontact.com/us/products/1049503>

Environmental product compliance

EU RoHS

Fulfills EU RoHS substance requirements	Yes, No exemptions
---	--------------------

China RoHS

Environment friendly use period (EFUP)	EFUP-E
	No hazardous substances above the limits

EU REACH SVHC

REACH candidate substance (CAS No.)	No substance above 0.1 wt%
-------------------------------------	----------------------------

EF3.1 Climate Change

CO2e kg	0.01 kg CO2e
---------	--------------

Phoenix Contact 2026 © - all rights reserved
<https://www.phoenixcontact.com>

Phoenix Contact USA
586 Fulling Mill Road
Middletown, PA 17057, United States
(+717) 944-1300
info@phoenixcon.com