

# IPD WD 5P2,5 M25 BK - Panel feed-through



1047345

<https://www.phoenixcontact.com/us/products/1047345>

Please be informed that the data shown in this PDF document is generated from our online catalog. Please find the complete data in the user documentation. Our general terms of use for downloads are valid.



Panel feed-through, Direct connection, connection method: Push-in connection/ Push-in connection, number of positions: 4+PE, M25, 0.5 mm<sup>2</sup> ... 2.5 mm<sup>2</sup>, 600 V, 20 A, PA, black, external cable diameter: 7 mm ... 11 mm and 11 mm ... 16 mm

## Your advantages

- Convenient: quick and easy assembly without special tools
- Fast and easy startup, thanks to tool-free Push-in connection technology
- Reliable installation in harsh environments with IP66, IP68, and IP69K throughout the entire system

## Commercial data

Item number	1047345
Packing unit	1 pc
Minimum order quantity	1 pc
Sales key	BF51
Product key	AF6ICA
GTIN	4055626646169
Weight per piece (including packing)	82.9 g
Weight per piece (excluding packing)	80.5 g
Customs tariff number	85366990
Country of origin	CN

# IPD WD 5P2,5 M25 BK - Panel feed-through



1047345

<https://www.phoenixcontact.com/us/products/1047345>

## Technical data

### Product properties

Product type	Panel feed-through
Product family	IPD
Number of positions	5
Connection profile	4+PE
Position marking	1, 2, 3, N, PE

### Insulation characteristics

Overvoltage category	III
Degree of pollution	3

### Connection data

#### Connection technology

Connection method On the device side	Push-in connection
Connection method On the field side	Push-in connection
Frequency of connections between conductors of the same cross section	max. 10

#### Conductor connection

Conductor cross-section flexibel	0.5 mm <sup>2</sup> ... 2.5 mm <sup>2</sup>
Conductor cross-section solid	0.5 mm <sup>2</sup> ... 2.5 mm <sup>2</sup>
Conductor cross-section with ferrule	0.5 mm <sup>2</sup> ... 2.5 mm <sup>2</sup>
Connection cross section AWG	20 ... 14

### Dimensions

Dimensional drawing	
Width	33 mm
Length	96.9 mm

### Electrical properties

Rated surge voltage (III/3)	6 kV
Rated current	20 A
Rated voltage (III/3)	600 V
Nominal voltage U <sub>N</sub>	690 V AC
	690 V DC
Nominal current I <sub>N</sub>	20 A (observe derating)

### Mechanical properties

# IPD WD 5P2,5 M25 BK - Panel feed-through



1047345

<https://www.phoenixcontact.com/us/products/1047345>

## Mechanical data

Insertion/withdrawal cycles	10
-----------------------------	----

## Material specifications

Color	black (RAL 9005)
Material Housing	PA
Material Seal	NBR (Field) EPDM (Device)
Flammability rating according to UL 94	V0
Contact material	Cu
Contact surface material	Ni/Sn

## Cable/line

External cable diameter	7 mm ... 11 mm
	11 mm ... 16 mm
Stripping length of the individual wire	10 mm
Position marking	1, 2, 3, N, PE

## Mounting

Mounting type	Front mounting M25
---------------	--------------------

## Environmental and real-life conditions

### Ambient conditions

Degree of protection	IP66
	IP68 (2 m / 24 h)
	IP69K
Impact strength	IK07
Ambient temperature (operation)	-40 °C ... 100 °C (T = 55 °C)
Temperature when conductor connected	-5 °C ... 50 °C
Ambient temperature (storage/transport)	-40 °C ... 100 °C
Resistance to UV radiation	yes

# IPD WD 5P2,5 M25 BK - Panel feed-through



1047345

<https://www.phoenixcontact.com/us/products/1047345>

## Drawings

Dimensional drawing

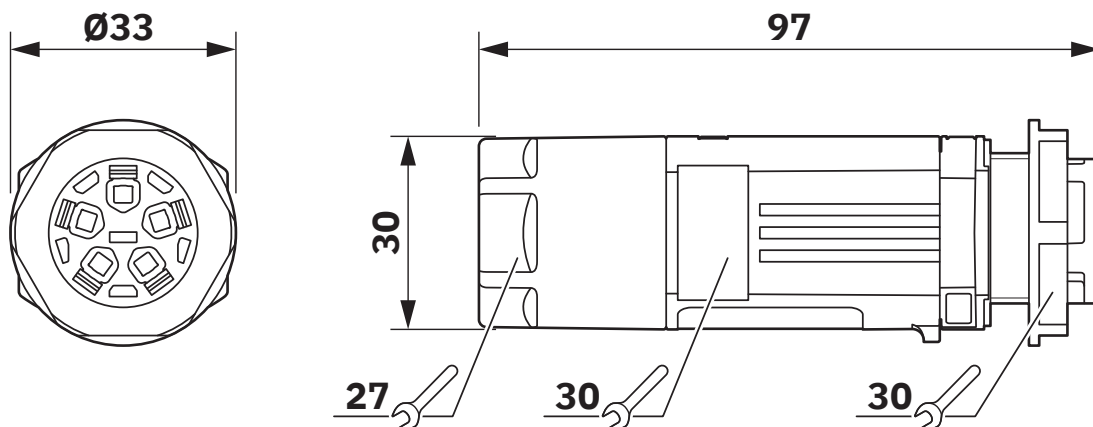

Diagram

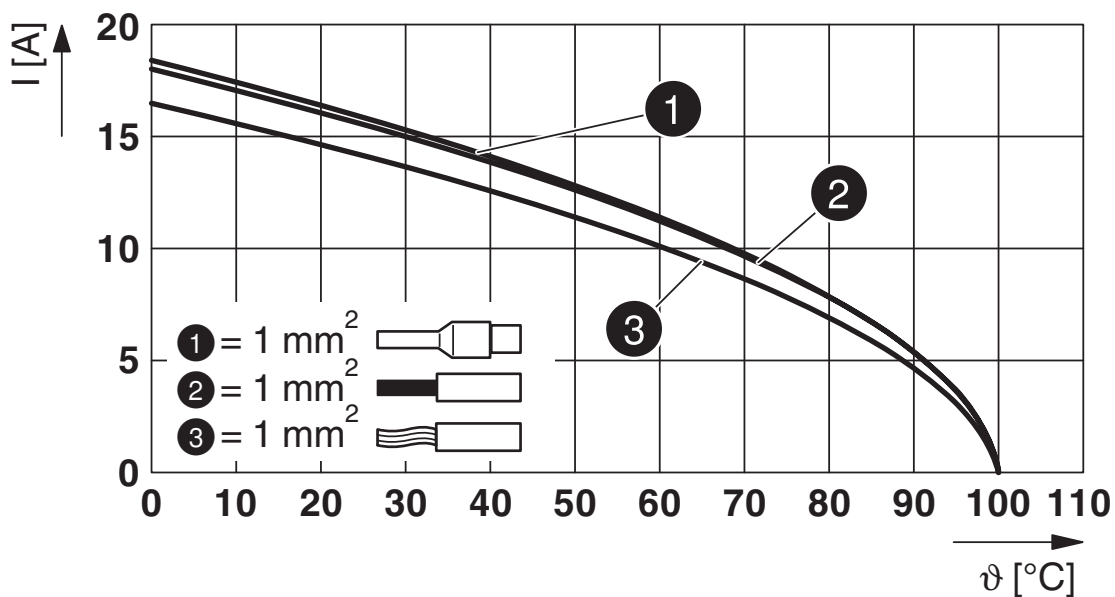

Derating diagram for 1.0 mm<sup>2</sup>

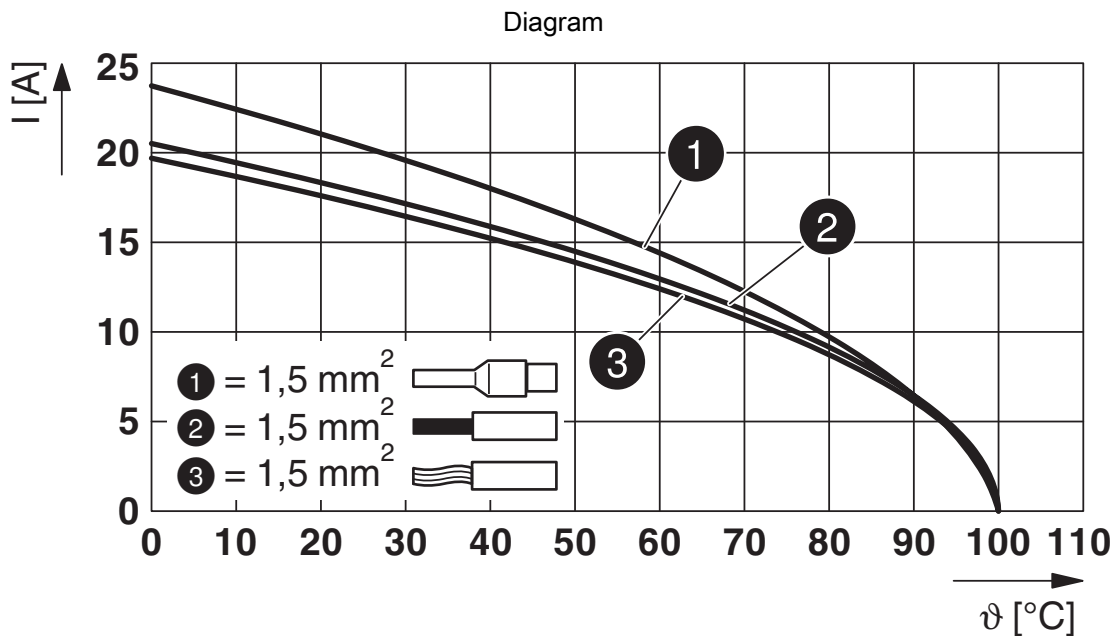

Derating diagram for 1.5 mm<sup>2</sup>

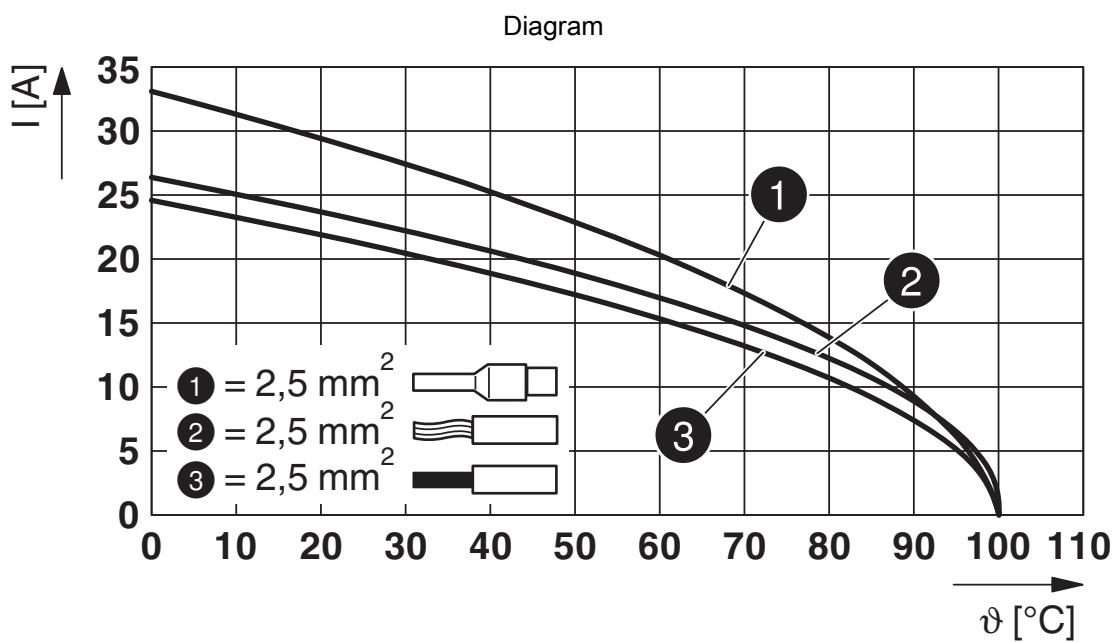

Derating diagram for 2.5 mm<sup>2</sup>

# IPD WD 5P2,5 M25 BK - Panel feed-through



1047345

<https://www.phoenixcontact.com/us/products/1047345>

## Approvals

To download certificates, visit the product detail page: <https://www.phoenixcontact.com/us/products/1047345>

 <b>VDE Zeichengenehmigung</b> Approval ID: 40049992				
	Nominal voltage $U_N$	Nominal current $I_N$	Cross section AWG	Cross section $\text{mm}^2$
keine				
	690 V	20 A	-	0.5 - 2.5

<b>DNV</b> Approval ID: TAE00004G2				
---------------------------------------	--	--	--	--

 <b>UL Listed</b> Approval ID: E468743				
	Nominal voltage $U_N$	Nominal current $I_N$	Cross section AWG	Cross section $\text{mm}^2$
keine				
Only rigid conductors	600 V	20 A	- 14	- 14
multi-stranded with ferrule	600 V	20 A	- 14	- 14

 <b>cUL Listed</b> Approval ID: E468743				
	Nominal voltage $U_N$	Nominal current $I_N$	Cross section AWG	Cross section $\text{mm}^2$
keine				
Only flexible conductors	600 V	15 A	- 14	-
Only rigid conductors	600 V	16 A	- 14	-
multi-stranded with ferrule	600 V	16 A	- 14	-

# IPD WD 5P2,5 M25 BK - Panel feed-through



1047345

<https://www.phoenixcontact.com/us/products/1047345>

## Classifications

### ECLASS

ECLASS-13.0	27440602
ECLASS-15.0	27440602

### ETIM

ETIM 10.0	EC002566
-----------	----------

### UNSPSC

UNSPSC 21.0	39121500
-------------	----------

# IPD WD 5P2,5 M25 BK - Panel feed-through



1047345

<https://www.phoenixcontact.com/us/products/1047345>

## Environmental product compliance

### EU RoHS

Fulfills EU RoHS substance requirements	Yes, No exemptions
---	--------------------

### China RoHS

Environment friendly use period (EFUP)	EFUP-E
	No hazardous substances above the limits

### EU REACH SVHC

REACH candidate substance (CAS No.)	No substance above 0.1 wt%
-------------------------------------	----------------------------

Phoenix Contact 2026 © - all rights reserved  
<https://www.phoenixcontact.com>

Phoenix Contact USA  
586 Fulling Mill Road  
Middletown, PA 17057, United States  
(+717) 944-1300  
[info@phoenixcon.com](mailto:info@phoenixcon.com)