

IPD WD 3P2,5 M20 GY - Panel feed-through



1047319

<https://www.phoenixcontact.com/us/products/1047319>

Please be informed that the data shown in this PDF document is generated from our online catalog. Please find the complete data in the user documentation. Our general terms of use for downloads are valid.



Panel feed-through, Direct connection, connection method: Push-in connection/ Push-in connection, number of positions: 2+PE, M20, 0.5 mm² ... 2.5 mm², 600 V, 20 A, PA, light gray, external cable diameter: 6 mm ... 9 mm and 8 mm ... 13 mm

Your advantages

- Convenient: quick and easy assembly without special tools
- Fast and easy startup, thanks to tool-free Push-in connection technology
- Reliable installation in harsh environments with IP66, IP68, and IP69K throughout the entire system

Commercial data

Item number	1047319
Packing unit	1 pc
Minimum order quantity	1 pc
Sales key	BF51
Product key	AF6IAA
GTIN	4055626648200
Weight per piece (including packing)	55.5 g
Weight per piece (excluding packing)	54 g
Customs tariff number	85366990
Country of origin	CN

IPD WD 3P2,5 M20 GY - Panel feed-through



1047319

<https://www.phoenixcontact.com/us/products/1047319>

Technical data

Product properties

Product type	Panel feed-through
Product family	IPD
Number of positions	3
Connection profile	2+PE
Position marking	L, N, PE

Insulation characteristics

Overvoltage category	III
Degree of pollution	3

Connection data

Connection technology

Connection method On the device side	Push-in connection
Connection method On the field side	Push-in connection
Frequency of connections between conductors of the same cross section	max. 10

Conductor connection

Conductor cross-section flexibel	0.5 mm ² ... 2.5 mm ²
Conductor cross-section solid	0.5 mm ² ... 2.5 mm ²
Conductor cross-section with ferrule	0.5 mm ² ... 2.5 mm ²
Connection cross section AWG	20 ... 14

Dimensions

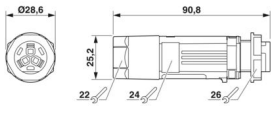
Dimensional drawing	
Width	28.6 mm
Length	90.8 mm

Electrical properties

Rated surge voltage (III/3)	6 kV
Rated current	20 A
Rated voltage (III/3)	600 V
Nominal voltage U _N	690 V AC 690 V DC
Nominal current I _N	20 A (observe derating)

Mechanical properties

Mechanical data

IPD WD 3P2,5 M20 GY - Panel feed-through



1047319

<https://www.phoenixcontact.com/us/products/1047319>

Insertion/withdrawal cycles	10
-----------------------------	----

Material specifications

Color	light gray (RAL 7035)
Material Housing	PA
Material Seal	NBR (Field) EPDM (Device)
Flammability rating according to UL 94	V0
Contact material	Cu
Contact surface material	Ni/Sn

Cable/line

External cable diameter	6 mm ... 9 mm 8 mm ... 13 mm
Stripping length of the individual wire	10 mm
Position marking	L, N, PE

Mounting

Mounting type	Front mounting M20
---------------	--------------------

Environmental and real-life conditions

Ambient conditions

Degree of protection	IP66 IP68 (2 m / 24 h) IP69K
Impact strength	IK07
Ambient temperature (operation)	-40 °C ... 100 °C (T = 55 °C)
Temperature when conductor connected	-5 °C ... 50 °C
Ambient temperature (storage/transport)	-40 °C ... 100 °C
Resistance to UV radiation	yes

IPD WD 3P2,5 M20 GY - Panel feed-through



1047319

<https://www.phoenixcontact.com/us/products/1047319>

Drawings

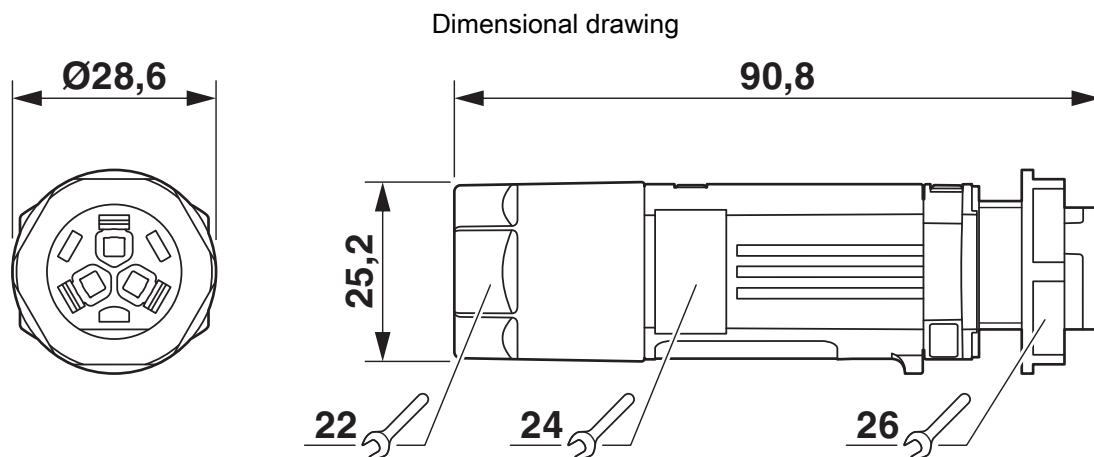

Diagram

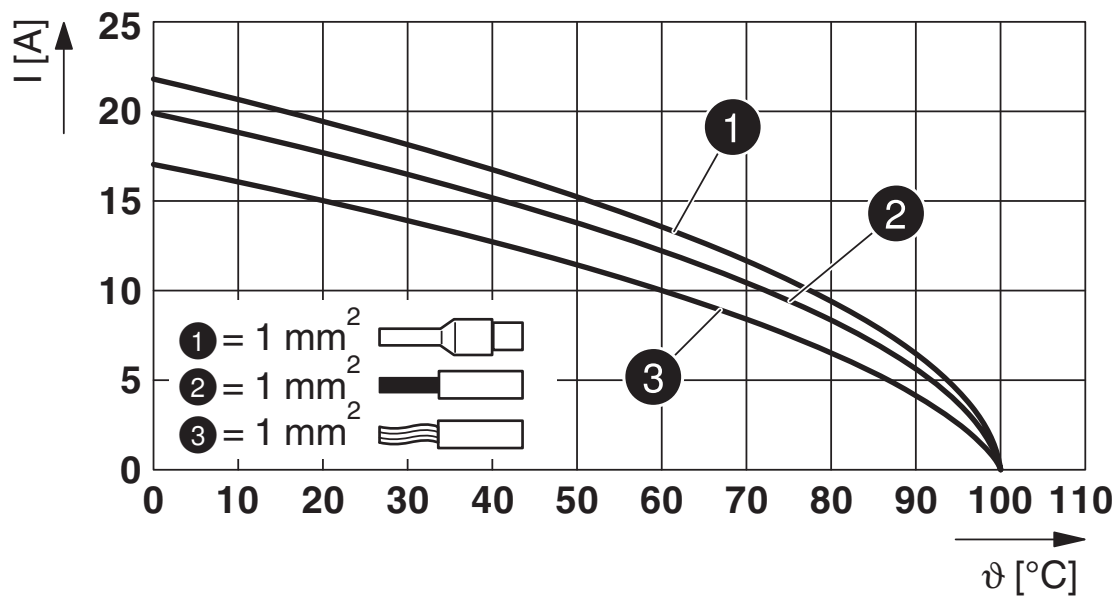

Derating diagram for 1.0 mm²

1047319

<https://www.phoenixcontact.com/us/products/1047319>

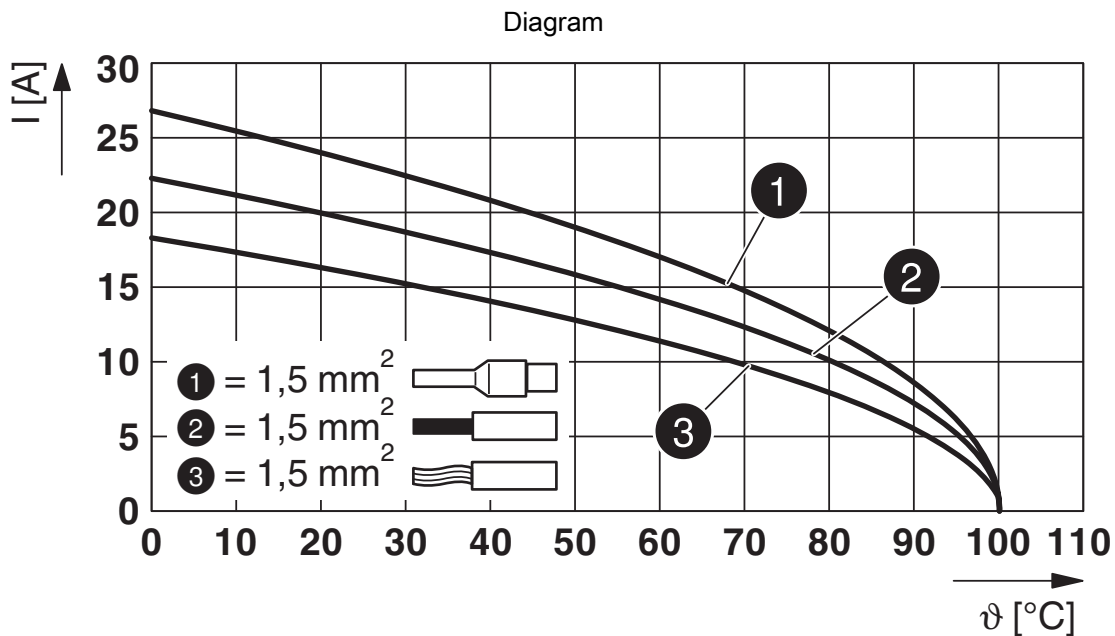

Derating diagram for 1.5 mm²

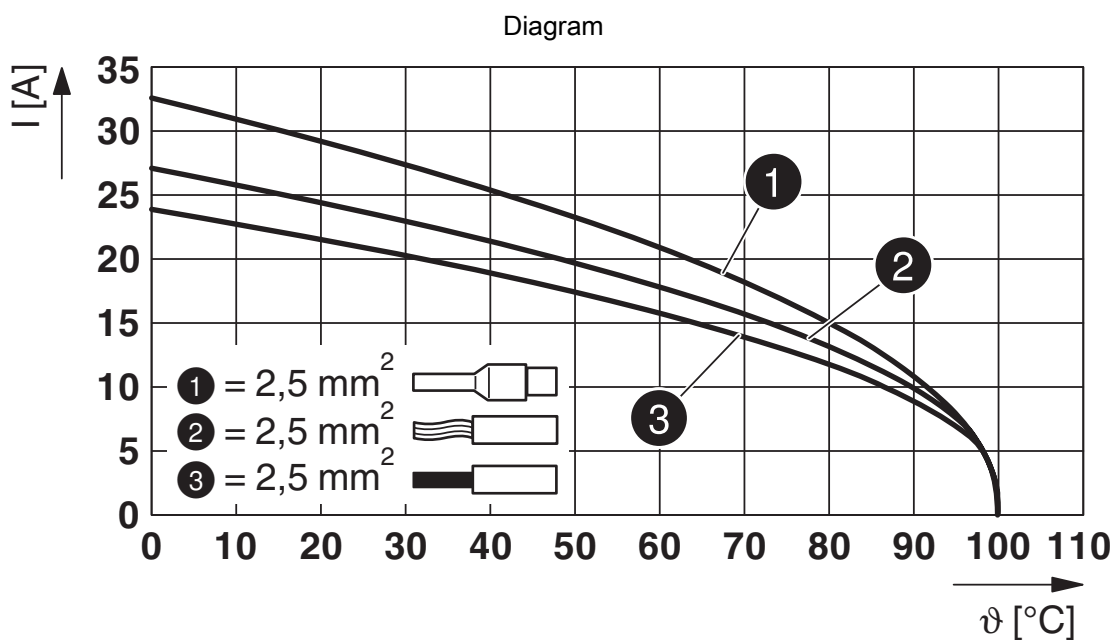

Derating diagram for 2.5 mm²

IPD WD 3P2,5 M20 GY - Panel feed-through



1047319

<https://www.phoenixcontact.com/us/products/1047319>

Approvals

To download certificates, visit the product detail page: <https://www.phoenixcontact.com/us/products/1047319>

 VDE Zeichengenehmigung Approval ID: 40049992				
	Nominal voltage U_N	Nominal current I_N	Cross section AWG	Cross section mm^2
keine				
	690 V	20 A	-	0.5 - 2.5

DNV Approval ID: TAE00004G2				
---------------------------------------	--	--	--	--

 UL Listed Approval ID: E468743				
	Nominal voltage U_N	Nominal current I_N	Cross section AWG	Cross section mm^2
keine				
Only rigid conductors	600 V	20 A	- 14	- 14
multi-stranded with ferrule	600 V	20 A	- 14	- 14

 cUL Listed Approval ID: E468743				
	Nominal voltage U_N	Nominal current I_N	Cross section AWG	Cross section mm^2
keine				
	600 V	17 A	- 14	-

IPD WD 3P2,5 M20 GY - Panel feed-through



1047319

<https://www.phoenixcontact.com/us/products/1047319>

Classifications

ECLASS

ECLASS-13.0	27440602
ECLASS-15.0	27440602

ETIM

ETIM 10.0	EC002566
-----------	----------

UNSPSC

UNSPSC 21.0	39121500
-------------	----------

IPD WD 3P2,5 M20 GY - Panel feed-through



1047319

<https://www.phoenixcontact.com/us/products/1047319>

Environmental product compliance

EU RoHS

Fulfills EU RoHS substance requirements	Yes, No exemptions
---	--------------------

China RoHS

Environment friendly use period (EFUP)	EFUP-E
	No hazardous substances above the limits

EU REACH SVHC

REACH candidate substance (CAS No.)	No substance above 0.1 wt%
-------------------------------------	----------------------------

EF3.1 Climate Change

CO2e kg	0.728 kg CO2e
---------	---------------

Phoenix Contact 2026 © - all rights reserved
<https://www.phoenixcontact.com>

Phoenix Contact USA
586 Fulling Mill Road
Middletown, PA 17057, United States
(+717) 944-1300
info@phoenixcon.com