

# FP 0,8/ 32-FV-SH 7,85 - SMD female connector shielded

1043683

<https://www.phoenixcontact.com/us/products/1043683>

Please be informed that the data shown in this PDF document is generated from our online catalog. Please find the complete data in the user documentation. Our general terms of use for downloads are valid.



Shielded SMD female connector, nominal current: 1.7 A, test voltage: 500 V AC, number of positions: 32, pitch: 0.8 mm, color: black, contact surface: Au, contact connection type: Socket, mounting: SMD soldering

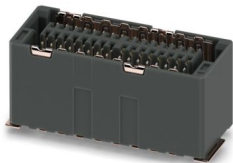

## Your advantages

- Gold-plated contacts ensure transfer quality remains stable over the long term
- Reliable mechanical and electrical connections, thanks to the double-sided ScaleX contact system
- Robustness: ScaleX technology for high tolerance compensation and protection of contacts
- Flexible device design: various numbers of positions, designs, and stack heights with high wipe lengths



## Commercial data

Item number	1043683
Packing unit	250 pc
Minimum order quantity	250 pc
Sales key	AA23
Product key	AAWDDC
GTIN	4055626616384
Weight per piece (including packing)	4.45 g
Weight per piece (excluding packing)	1.36 g
Customs tariff number	85366930
Country of origin	CZ

# FP 0,8/ 32-FV-SH 7,85 - SMD female connector shielded



1043683

<https://www.phoenixcontact.com/us/products/1043683>

## Technical data

### Product properties

Product type	Shielded SMD female connector
Product family	FP 0,8/...-FV-SH 7,85
Number of positions	32
Pitch	0.8 mm
Number of rows	2
Pin layout	Linear pad geometry
Electrical characteristic	shielded

### Electrical properties

#### Properties

Nominal current $I_N$	1.7 A IEC 60512-5-2:2002-02 (at 20°C 80-pos.)
Contact resistance	15 mΩ
Test voltage	500 V AC IEC 60512-4-1:2003-05
Electrical characteristic	shielded

#### Data transmission

Data transmission rate	16 Gbps
------------------------	---------

### Mounting

Mounting type	SMD soldering
Pin layout	Linear pad geometry

#### Processing notes

Process	Reflow soldering
Moisture Sensitive Level	MSL 1
Classification temperature $T_C$	260 °C
Solder cycles in the reflow	3

### Material specifications

#### Material data - contact

Note	WEEE/RoHS-compliant, free of whiskers according to IEC 60068-2-82/JEDEC JESD 201
Contact material	Cu alloy
Surface characteristics	Selective coating
Metal surface contact area (top layer)	Gold (min. 0.5 μm Au)
Metal surface contact area (middle layer)	Nickel (1.27 μm - 4 μm Ni)
Metal surface soldering area (top layer)	Tin (2 μm - 6 μm Sn)
Metal surface soldering area (middle layer)	Nickel (1.27 μm - 4 μm Ni)

#### Material data - housing

Color (Housing)	black (9005)
-----------------	--------------

# FP 0,8/ 32-FV-SH 7,85 - SMD female connector shielded



1043683

<https://www.phoenixcontact.com/us/products/1043683>

Insulating material	LCP
Insulating material group	IIIb
CTI according to IEC 60112	150
Flammability rating according to UL 94	V0

## Notes

Notes on operation	The permissible voltage during operation depends on the application, taking into consideration the air clearances and creepage distances within the scope of insulation requirements in accordance with IEC 60664-1.
Details for soldering processes	The items are suitable for assembly on both sides and for overhead soldering.

## Dimensions

Dimensional drawing	
Pitch	0.8 mm
Width [w]	17.58 mm
Height [h]	8.45 mm
Length [l]	7.1 mm
Installed height	7.85 mm

## Application

Contact cover	0.8 mm
Center offset	± 0.7 mm in longitudinal and transverse direction
Stack height	9 mm Tolerance: +1,5 mm (in combination with Range of articles:FP 0,8/...-MV-SH 1,15)
	10.5 mm Tolerance: +1,5 mm (in combination with Range of articles:FP 0,8/...-MV-SH 2,65)
	15 mm Tolerance: +1,5 mm (in combination with Range of articles:FP 0,8/...-MV-SH 7,15)
	16.5 mm Tolerance: +1,5 mm (in combination with Range of articles:FP 0,8/...-MV-SH 8,65)
Wipe length	1.5 mm
Angular tolerance	± 5 ° in longitudinal and transverse direction (when plugging in)
	± 5 ° in longitudinal and transverse direction (when plugged in)
Axial offset in X direction (longitudinal)	± 0.3 mm (Tolerance compensation when plugged in)
Axial offset in Y direction (transversal)	± 0.3 mm (Tolerance compensation when plugged in)

## PCB design

Pad geometry	0.5 x 1.1 mm
--------------	--------------

## Electrical tests

# FP 0,8/ 32-FV-SH 7,85 - SMD female connector shielded



1043683

<https://www.phoenixcontact.com/us/products/1043683>

## Thermal test | Test group C

Specification	IEC 60512-5-2:2002-02
Tested number of positions	80

## Insulation resistance

Specification	IEC 60512-3-1:2002-02
Insulation resistance, neighboring positions	$\geq 5 \text{ G}\Omega$

## Air clearances and creepage distances |

Insulating material group	IIIb
Minimum value for clearance and creepage distance	0.25 mm

## Environmental and real-life conditions

### Durability test

Specification	IEC 60512-9-1:2010-03 (following)
Impulse withstand voltage at sea level	0.8 kV
Contact resistance $R_1$	15 m $\Omega$
Contact resistance $R_2$	15 m $\Omega$
Insertion/withdrawal cycles	500
Insulation resistance, neighboring positions	$\geq 5 \text{ G}\Omega$

### Climatic test

Specification	IEC 60512-11-7:2003-05
Corrosive stress	Method 1, 10 days
Power-frequency withstand voltage	500 V AC

### Vibration test

Specification	IEC 60068-2-6:2007-12
Frequency	10 - 2000 - 10 Hz
Sweep speed	1 octave/min
Amplitude	1.5 mm (10 Hz ... 60.1 Hz)
Acceleration	200 m/s <sup>2</sup> (58 Hz ... 2000 Hz)
Test duration per axis	2.5 h
Test directions	X-, Y- and Z-axis

### Shocks

Specification	IEC 60068-2-27:2008-02
Pulse shape	Semi-sinusoidal
Acceleration	490 m/s <sup>2</sup>
Shock duration	11 ms
Test directions	X-, Y- and Z-axis (pos. and neg.)

### Railway application: Oscillation/broadband noise

Specification	DIN EN 50155 (VDE 0115-200):2022-06 IEC 61373:2010-05
Spectrum	Long life test category 2, bogie-mounted

# FP 0,8/ 32-FV-SH 7,85 - SMD female connector shielded

1043683

<https://www.phoenixcontact.com/us/products/1043683>

Frequency	$f_1 = 5 \text{ Hz}$ to $f_2 = 250 \text{ Hz}$
ASD level	$6.12 \text{ (m/s}^2\text{)}^2\text{/Hz}$
Acceleration	$30.6 \text{ m/s}^2$
Test duration per axis	5 h
Test directions	X-, Y- and Z-axis
Contact interruption	$< 1 \mu\text{s}$
Result	Test passed

## Railway application: Shocks

Specification	DIN EN 50155 (VDE 0115-200):2022-06 IEC 61373:2010-05
Pulse shape	Semi-sinusoidal
Acceleration	$490 \text{ m/s}^2$
Shock duration	11 ms
Number of shocks per direction	3
Test directions	X-, Y- and Z-axis (pos. and neg.)
Contact interruption	$< 1 \mu\text{s}$
Result	Test passed

## Ambient conditions

Ambient temperature (storage/transport)	$-40 \text{ }^\circ\text{C} \dots 70 \text{ }^\circ\text{C}$
Relative humidity (storage/transport)	30 % ... 70 %
Ambient temperature (assembly)	$-5 \text{ }^\circ\text{C} \dots 100 \text{ }^\circ\text{C}$
Ambient temperature (operation)	$-55 \text{ }^\circ\text{C} \dots 125 \text{ }^\circ\text{C}$

## Packaging specifications

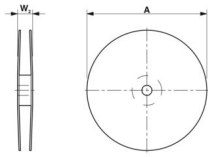
Dimensional drawing	
Type of packaging	16 mm wide tape
[W] tape width	16 mm
[W2] coil overall dimension	$\leq 22.4 \text{ mm}$
[A] coil diameter	$\leq 330 \text{ mm}$
Outer packaging type	Transparent-Bag

# FP 0,8/ 32-FV-SH 7,85 - SMD female connector shielded

1043683

<https://www.phoenixcontact.com/us/products/1043683>

## Drawings

Schematic diagram



Diagram



Type: FP 0,8/...-MV-SH 2,65 with FP 0,8/...-FV-SH 7,85

# FP 0,8/ 32-FV-SH 7,85 - SMD female connector shielded



1043683

<https://www.phoenixcontact.com/us/products/1043683>

Diagram

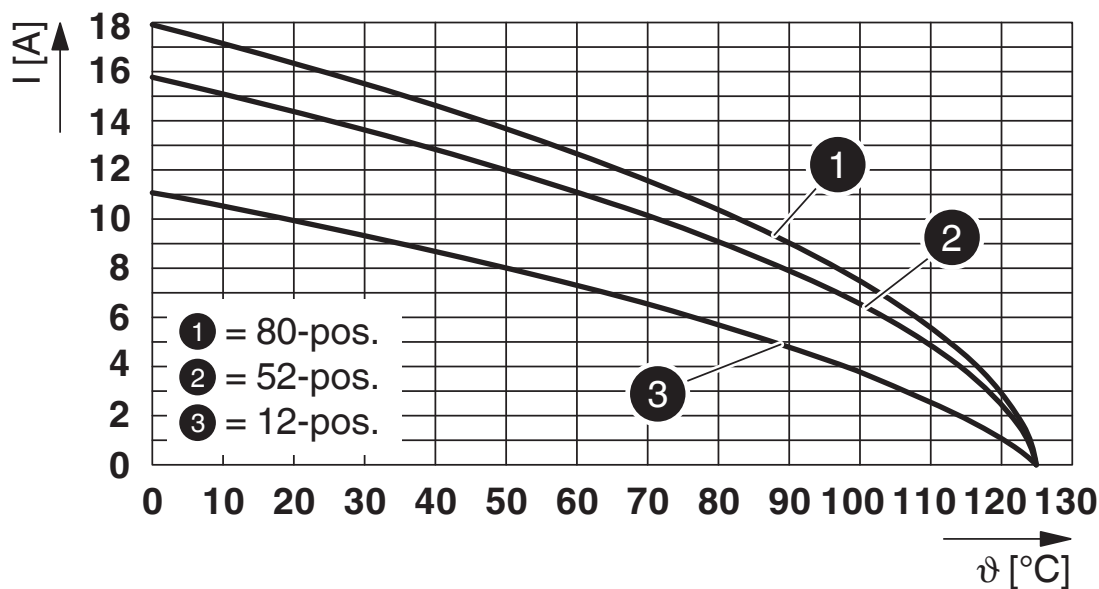

Type: FP 0,8/...-MV-SH 2,65 with FP 0,8/...-FV-SH 7,85 – shield current carrying capacity

Diagram

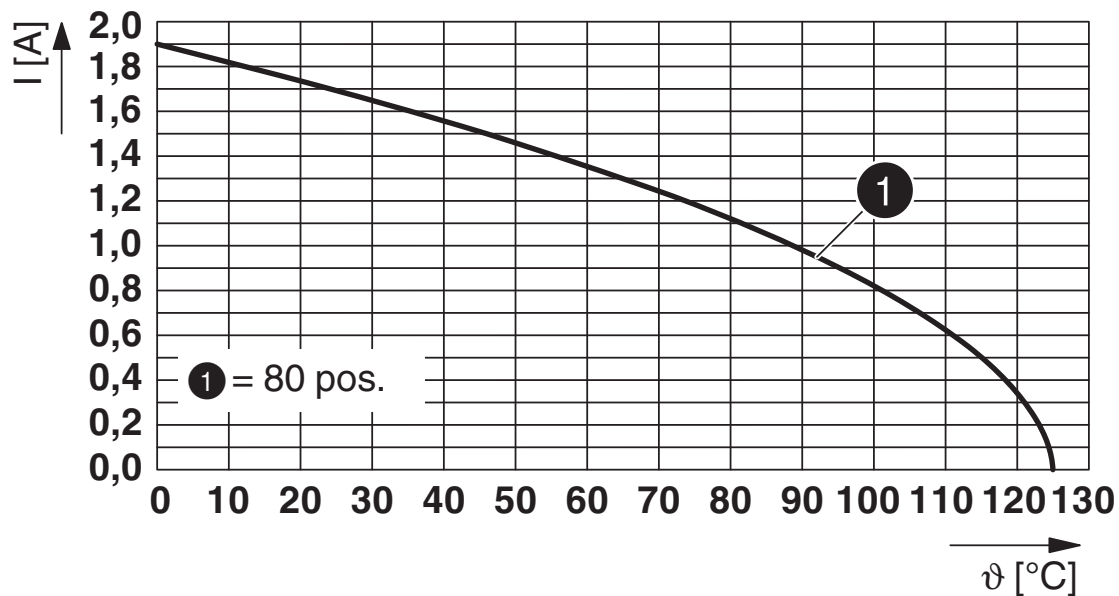

Type: FP 0,8/...-MV-SH 1,15 with FP 0,8/...-FV-SH 7,85

# FP 0,8/ 32-FV-SH 7,85 - SMD female connector shielded



1043683

<https://www.phoenixcontact.com/us/products/1043683>

Diagram



Type: FP 0,8/...-MV-SH 8,65 with FP 0,8/...-FV-SH 7,85 – contacts

Diagram



Type: FP 0,8/...-MV-SH 8,65 with FP 0,8/...-FV-SH 7,85 - shroud

# FP 0,8/ 32-FV-SH 7,85 - SMD female connector shielded



1043683

<https://www.phoenixcontact.com/us/products/1043683>

## Approvals

To download certificates, visit the product detail page: <https://www.phoenixcontact.com/us/products/1043683>



**cULus Recognized**

Approval ID: E118976-20190703

# FP 0,8/ 32-FV-SH 7,85 - SMD female connector shielded



1043683

<https://www.phoenixcontact.com/us/products/1043683>

## Classifications

### ECLASS

ECLASS-13.0	27460201
ECLASS-15.0	27460201

### ETIM

ETIM 10.0	EC002637
-----------	----------

### UNSPSC

UNSPSC 21.0	39121400
-------------	----------

# FP 0,8/ 32-FV-SH 7,85 - SMD female connector shielded



1043683

<https://www.phoenixcontact.com/us/products/1043683>

## Environmental product compliance

### EU RoHS

Fulfills EU RoHS substance requirements	Yes, No exemptions
---	--------------------

### China RoHS

Environment friendly use period (EFUP)	EFUP-E
	No hazardous substances above the limits

### EU REACH SVHC

REACH candidate substance (CAS No.)	No substance above 0.1 wt%
-------------------------------------	----------------------------

### EF3.1 Climate Change

CO2e kg	0.505 kg CO2e
---------	---------------

Phoenix Contact 2026 © - all rights reserved  
<https://www.phoenixcontact.com>

Phoenix Contact USA  
586 Fulling Mill Road  
Middletown, PA 17057, United States  
(+717) 944-1300  
[info@phoenixcon.com](mailto:info@phoenixcon.com)