

REL-MR-BL- 48DC/21-21 - Single relay



1109544

<https://www.phoenixcontact.com/gb/products/1109544>

Please be informed that the data shown in this PDF document is generated from our online catalog. Please find the complete data in the user documentation. Our general terms of use for downloads are valid.

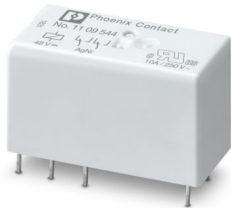

Pluggable miniature power relay in basic design, with power contact, 2 changeover contacts, input voltage 48 V DC

Commercial data

Item number	1109544
Packing unit	20 pc
Minimum order quantity	20 pc
Note	Made to order (non-returnable)
Sales key	DKF935
Product key	DKF935
GTIN	4063151021436
Weight per piece (including packing)	14.24 g
Weight per piece (excluding packing)	15 g
Customs tariff number	85364190
Country of origin	AT

1109544

<https://www.phoenixcontact.com/gb/products/1109544>

Technical data

Product properties

Product type	Single relay
Product family	ESSENTIAL edition
Operating mode	100% operating factor
Mechanical service life	3x 10 ⁷ cycles

Insulation characteristics

Insulation	Basic insulation
Overvoltage category	III
Pollution degree	3

Data management status

Date of last data management	01.04.2026
------------------------------	------------

Electrical properties

Service life electrical	see diagram
Maximum power dissipation for nominal condition	0.4 W
Test voltage (Winding/contact)	5 kV AC (50 Hz, 1 min.)
Test voltage (Contact/contact)	2.5 kV AC (50 Hz, 1 min.)
Test voltage (open contact)	1 kV (50 Hz, 1 min.)
Rated insulation voltage	250 V AC
Rated surge voltage	4 kV

Input data

Coil side

Nominal input voltage U_N	48 V DC
Input voltage range	33.6 V DC ... 108 V DC
Drive and function	monostable
Drive (polarity)	non-polarized
Typical input current at U_N	8.7 mA
Typical response time	8 ms
Typical release time	6 ms
Coil voltage	48 V DC
Coil resistance	5.5 k Ω \pm 10 %

Output data

Switching

Contact switching type	2 changeover contacts
Type of switch contact	Single contact
Contact material	AgNi
Maximum switching voltage	250 V AC/DC

REL-MR-BL- 48DC/21-21 - Single relay



1109544

<https://www.phoenixcontact.com/gb/products/1109544>

Minimum switching voltage	5 V (at 10 mA)
Limiting continuous current	8 A
Maximum inrush current	12 A (20 ms)
Min. switching current	10 mA (At 5 V)
Interrupting rating (ohmic load) max.	190 W (at 24 V DC)
	85 W (at 48 V DC)
	60 W (at 60 V DC)
	44 W (at 110 V DC)
	60 W (at 220 V DC)
	2000 VA (for 250 V AC)
Switching capacity	2 A (at 24 V, DC13)
	1.5 A (at 230 V, AC15)

Connection data

Connection method	Plug / solder connection
-------------------	--------------------------

Dimensions

Item dimensions

Width	12.7 mm
Height	29 mm
Depth	15.7 mm

Material specifications

Color	white (RAL 9010)
-------	------------------

Environmental and real-life conditions

Ambient conditions

Degree of protection	RT II
Ambient temperature (operation)	-40 °C ... 85 °C
Ambient temperature (storage/transport)	-40 °C ... 85 °C

Standards and regulations

Standards/regulations	IEC 60664
	EN 61810-1

Mounting

Mounting type	Plug-in mounting
Mounting position	any

Drawings

Dimensional drawing

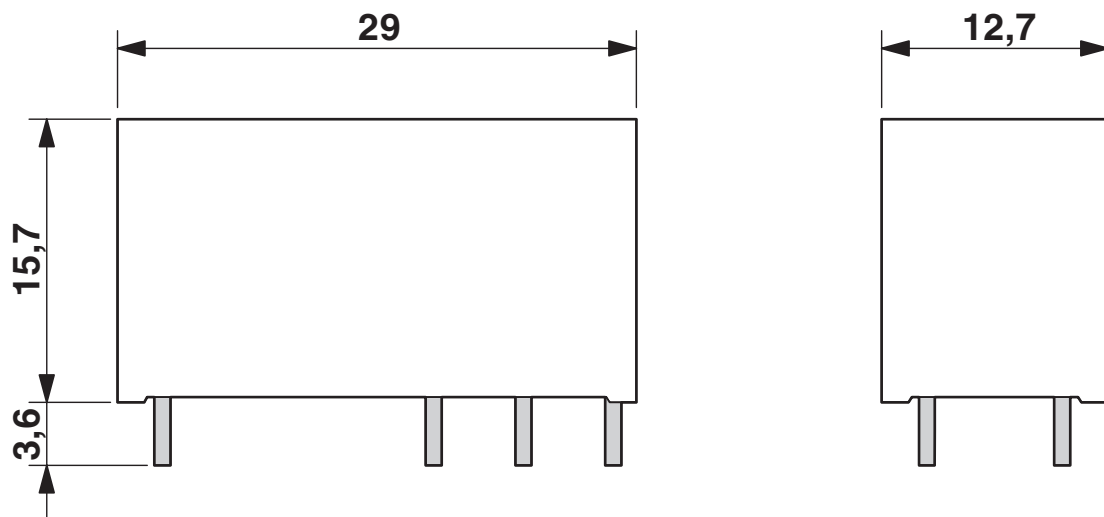

Diagram

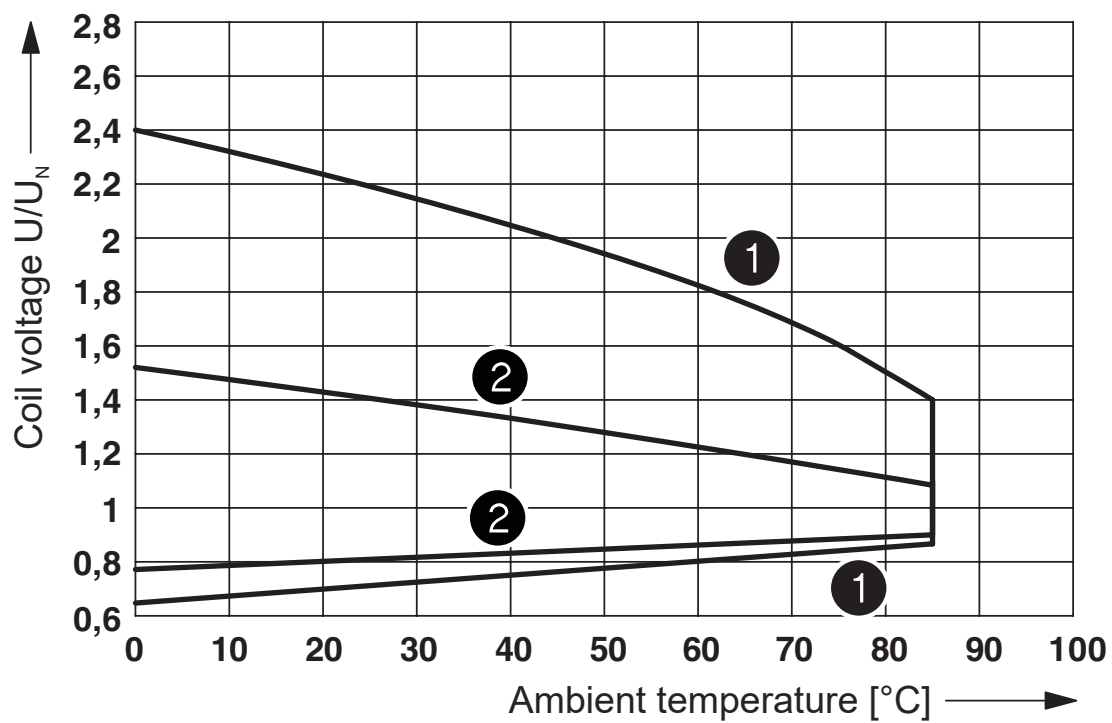

- ① DC coils
- ② AC coils

Operating voltage range

Diagram

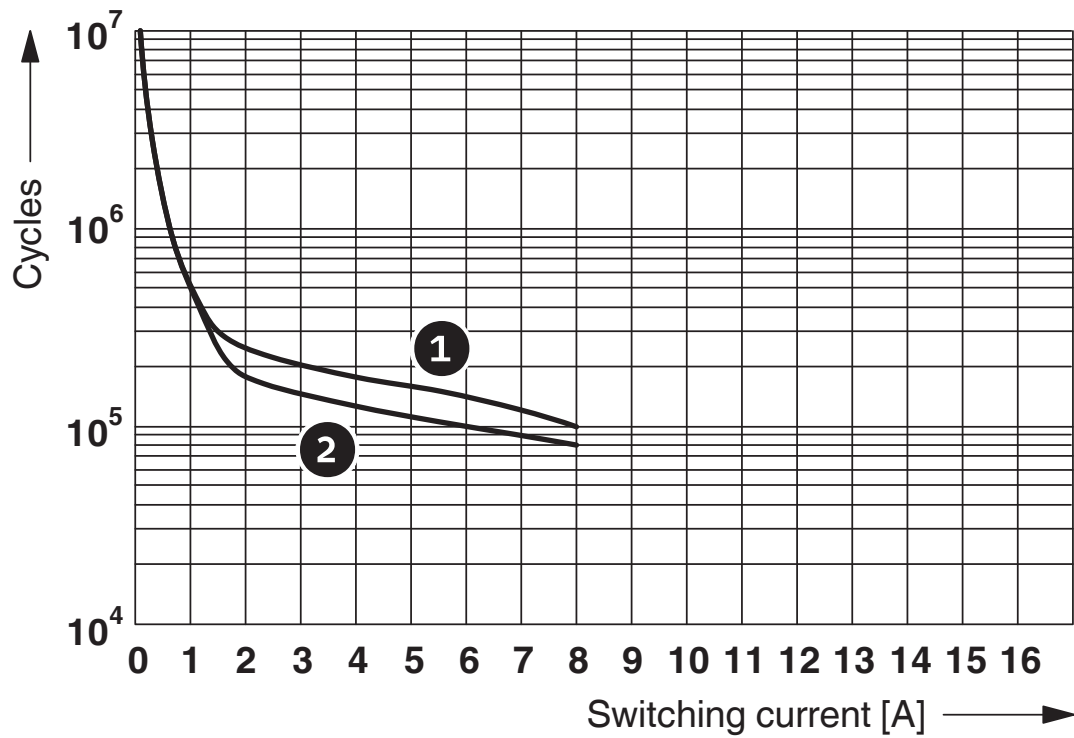

- ① 250 V AC, ohmic load (DC coils)
- ② 250 V AC, ohmic load (AC coils)

Electrical service life

Diagram

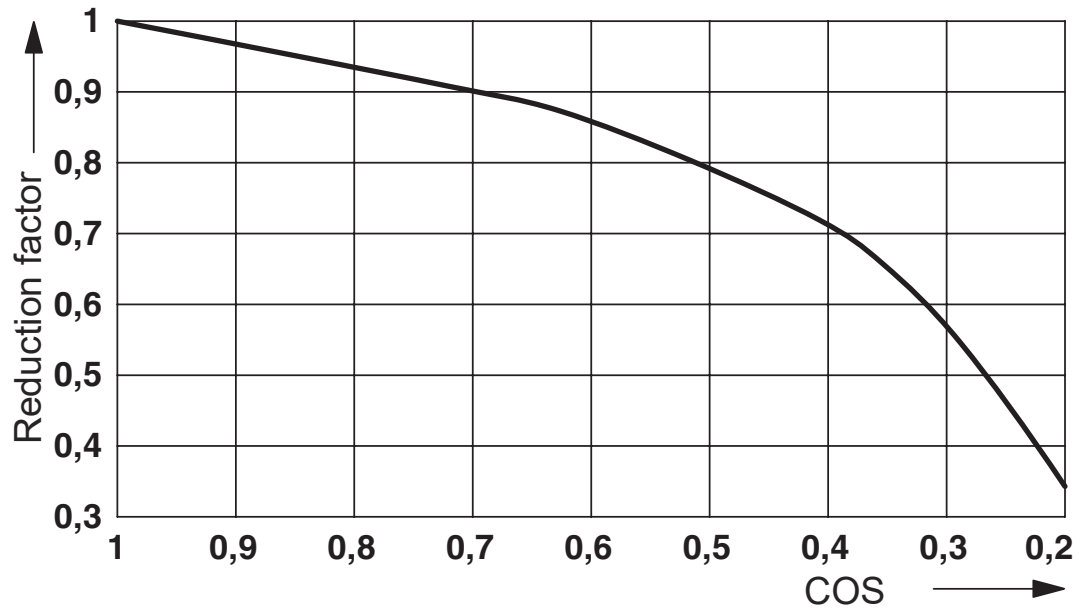

Service life reduction factor with various cos phi

Diagram



Permissible humidity for operation and storage.

The maximum permissible ambient temperature as specified in the data sheet must be observed.

Area A: Ice buildup at ambient temperatures $\leq 0^\circ\text{C}$ must be prevented

Area B: Condensation at ambient temperatures $> 0^\circ\text{C}$ must be prevented

On 30 full days that are naturally distributed across an entire year, a humidity level of 95% is permissible at an ambient temperature $\leq 25^\circ\text{C}$.

Circuit diagram

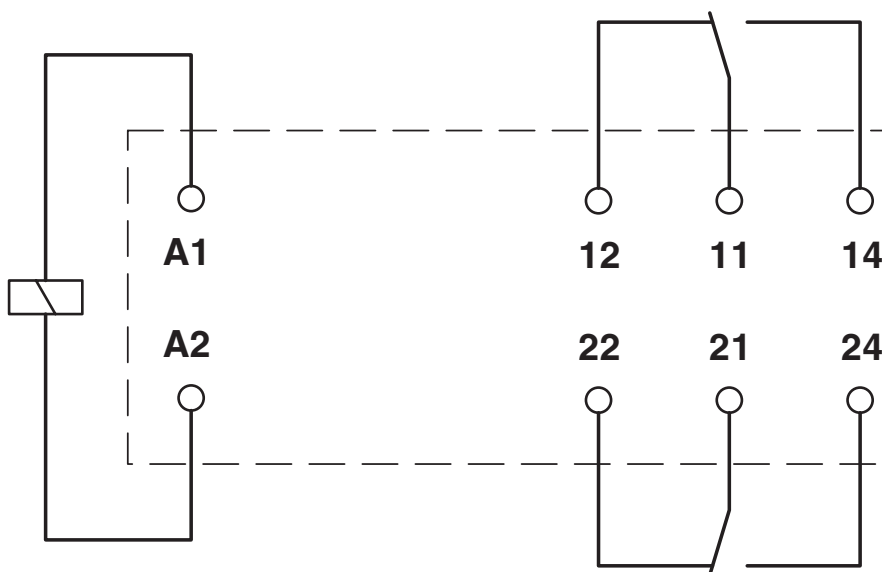

REL-MR-BL- 48DC/21-21 - Single relay



1109544

<https://www.phoenixcontact.com/gb/products/1109544>

Drilling plan/solder pad geometry

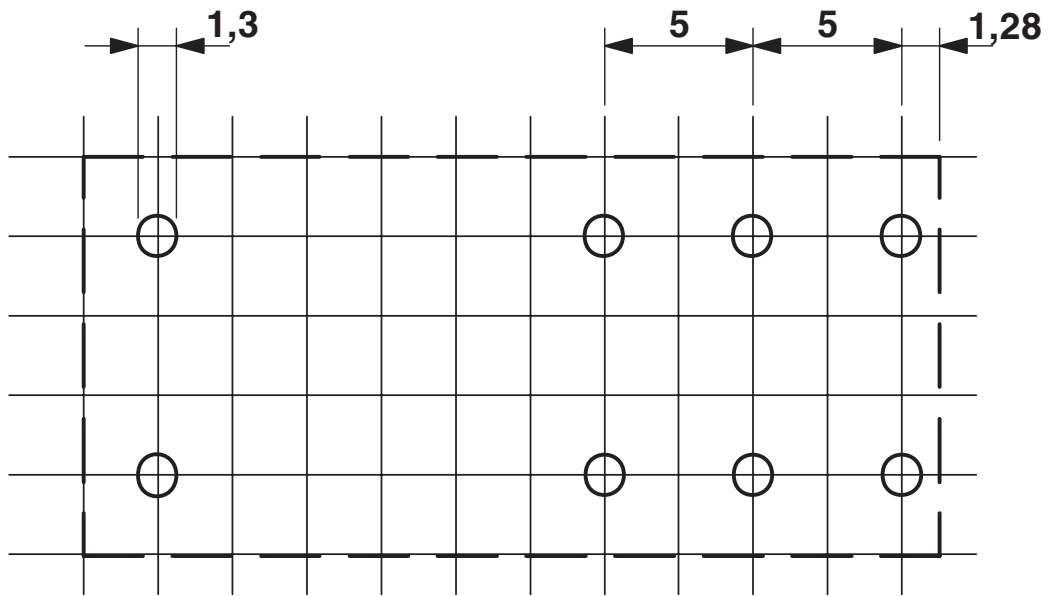

Basic pitch 2.5 mm

REL-MR-BL- 48DC/21-21 - Single relay



1109544

<https://www.phoenixcontact.com/gb/products/1109544>

Approvals

To download certificates, visit the product detail page: <https://www.phoenixcontact.com/gb/products/1109544>



cUL Recognized
Approval ID: FILE E 228652



UL Recognized
Approval ID: FILE E 228652

REL-MR-BL- 48DC/21-21 - Single relay



1109544

<https://www.phoenixcontact.com/gb/products/1109544>

Classifications

ECLASS

ECLASS-13.0	27371601
ECLASS-15.0	27371601

ETIM

ETIM 10.0	EC001437
-----------	----------

UNSPSC

UNSPSC 21.0	39122300
-------------	----------

REL-MR-BL- 48DC/21-21 - Single relay



1109544

<https://www.phoenixcontact.com/gb/products/1109544>

Environmental product compliance

EU RoHS

Fulfills EU RoHS substance requirements	Yes, No exemptions
-----------------------------------------	--------------------

China RoHS

Environment friendly use period (EFUP)	EFUP-E
	No hazardous substances above the limits

EU REACH SVHC

REACH candidate substance (CAS No.)	No substance above 0.1 wt%
-------------------------------------	----------------------------

EF3.1 Climate Change

CO2e kg	0.11 kg CO2e
---------	--------------

Phoenix Contact 2026 © - all rights reserved
<https://www.phoenixcontact.com>

PHOENIX CONTACT Ltd
Halesfield 13, Telford
Shropshire, TF7 4PG
01952 681700
info@phoenixcontact.co.uk