

MACX MCR-TC-I-C - Temperature measuring transducer



1052459

<https://www.phoenixcontact.com/gb/products/1052459>

Please be informed that the data shown in this PDF document is generated from our online catalog. Please find the complete data in the user documentation. Our general terms of use for downloads are valid.



Temperature transducer: converts signals from thermocouples and mV sources into 0/4...20 mA signals. Order configuration, freely programmable, 3-way electrical isolation, screw connection, SIL.

Your advantages

- Input for thermocouples and mV sources
- Power supply possible via DIN rail connector
- Programming possible during operation, when measuring circuit is connected, and also when power is switched off using the IFS-USB-PROG-ADAPTER programming adapter
- Installation in zone 2, protection type "ec" (EN 60079-7) permitted
- 3-way electrical isolation
- Status indicator for supply voltage, cable, sensor, and module errors
- Configuration via software (FDT/DTM): sensor type, connection technology, measuring range, measuring unit, filter, alarm signal, and output range
- Output: 0 mA ... 20 mA or 4 mA ... 20 mA

Commercial data

Item number	1052459
Packing unit	1 pc
Minimum order quantity	1 pc
Note	Made to order (non-returnable)
Sales key	DK1115
Product key	DK1115
Weight per piece (including packing)	150 g
Weight per piece (excluding packing)	150 g
Customs tariff number	85437090
Country of origin	DE

MACX MCR-TC-I-C - Temperature measuring transducer



1052459

<https://www.phoenixcontact.com/gb/products/1052459>

Technical data

Notes

Utilization restriction

EMC note	EMC: class A product, see manufacturer's declaration in the download area
----------	---

Product properties

Product type	Temperature transmitter
Product family	MACX Analog
Application	Temperature
Configuration	Software

System properties

Functionality

Configuration	Software
---------------	----------

Electrical properties

Electrical isolation	3-way isolation
Electrical isolation between input and output	yes
Cold point error, max.	± 2 K
Step response (0–99%)	≤ 1.7 s (with filter factor = 1)
Temperature coefficient, typical	0.01 %/K
Transmission error, typical	0.1 % (For full identification of transmission errors, see the data sheet)

Electrical isolation

Test voltage	2.5 kV AC (50 Hz, 60 s)
Overvoltage category	II
Pollution degree	2

Electrical isolation Input/output/power supply IEC/EN 61010-1

Standards/regulations	IEC/EN 61010-1
Rated insulation voltage	300 V _{rms}
Insulation	Safe isolation

Electrical isolation Input/output IEC/EN 60079-11

Standards/regulations	IEC/EN 60079-11
Rated insulation voltage	375 V _{PP}

Electrical isolation Input/power supply IEC/EN 60079-11

Standards/regulations	IEC/EN 60079-11
Rated insulation voltage	375 V _{PP}

Supply

MACX MCR-TC-I-C - Temperature measuring transducer



1052459

<https://www.phoenixcontact.com/gb/products/1052459>

Nominal supply voltage	24 V DC -20 % ... +25 %
Supply voltage range	19.2 V DC ... 30 V DC
Max. current consumption	< 40 mA (24 V DC)
Power dissipation	≤ 0.76 W
Power consumption	≤ 1 W

Input data

Signal

Number of inputs	1
Input signal	Temperature
	Voltage

Measurement

Sensor types that can be used (TC)	B, E, J, K, N, R, S, T, L, U, C, D, A-1, A-2, A-3, M, Lr
Temperature measuring range	-250 °C ... 2500 °C (Range depending on the sensor type)
Temperature measuring range: Type B thermocouple	500 °C ... 1820 °C
Temperature measuring range: Type E thermocouple	-230 °C ... 1000 °C
Temperature measuring range: Type J thermocouple	-210 °C ... 1200 °C
Temperature measuring range: Type K thermocouple	-250 °C ... 1372 °C
Temperature measuring range: Type N thermocouple	-200 °C ... 1300 °C
Temperature measuring range: Type R thermocouple	-50 °C ... 1768 °C
Temperature measuring range: Type S thermocouple	-50 °C ... 1768 °C
Temperature measuring range: Type T thermocouple	-200 °C ... 400 °C
Temperature measuring range: Type L thermocouple	-200 °C ... 900 °C
Temperature measuring range: Type U thermocouple	-200 °C ... 600 °C
Temperature measuring range: Type C thermocouple	0 °C ... 2315 °C
Temperature measuring range: Type D thermocouple	0 °C ... 2315 °C
Temperature measuring range: Type A1 GOST thermocouple	0 °C ... 2500 °C
Temperature measuring range: Type A2 GOST thermocouple	0 °C ... 1800 °C
Temperature measuring range: Type A3 GOST thermocouple	0 °C ... 1800 °C
Temperature measuring range: Type M GOST thermocouple	-200 °C ... 100 °C
Temperature measuring range: Type L GOST thermocouple	-200 °C ... 800 °C
Linear mV signal range	-1000 mV ... 1000 mV
Temperature measuring range	≥ 50 K (Thermocouples)

Output data

Signal: Current

Number of outputs	1
Configurable/programmable	Yes
Current output signal	0 mA ... 20 mA
	4 mA ... 20 mA (SIL)
Load/output load current output	≤ 600 Ω
Output ripple (current)	< 15 μA _{PP}
	< 10 μA _{rms}

MACX MCR-TC-I-C - Temperature measuring transducer



1052459

<https://www.phoenixcontact.com/gb/products/1052459>

Behavior in the event of a sensor error	Freely definable
---	------------------

Connection data

Connection method	Screw connection
Stripping length	7 mm
Screw thread	M3
Conductor cross-section rigid	0.2 mm ² ... 2.5 mm ²
Conductor cross-section flexible	0.2 mm ² ... 2.5 mm ²
Conductor cross-section AWG	24 ... 14
Tightening torque	0.5 Nm ... 0.6 Nm

Test socket

Max. diameter	2 mm
---------------	------

Ex data

Ex installation (EPL)	Gc
	Div. 2

Signaling

Status display	Green LED (supply voltage)
	Red LED, flashing 2.8 Hz (cable error, sensor error on input or output, ERR)
	Red LED, flashing 1.2 Hz (simulation mode, ERR)
	Red LED, permanently on (module error, ERR)

Dimensions

Dimensional drawing	
Width	12.5 mm
Height	112.5 mm
Depth	113.7 mm
Depth NS 35/7,5	114.5 mm (Snapped onto DIN rail NS 35/7,5 in accordance with EN 60715)

Material specifications

Color	gray (RAL 7042)
Flammability rating according to UL 94 (Housing)	V0 (Housing)
Housing material	PA 6.6-FR

Environmental and real-life conditions

Ambient conditions

MACX MCR-TC-I-C - Temperature measuring transducer



1052459

<https://www.phoenixcontact.com/gb/products/1052459>

Degree of protection	IP20
Ambient temperature (operation)	-40 °C ... 70 °C (Any mounting position)
Ambient temperature (storage/transport)	-40 °C ... 80 °C
Permissible humidity (operation)	5 % ... 95 % (non-condensing)

Altitude range (≤ 2000 m)

Altitude	≤ 2000 m (The technical data refers to altitudes ≤2000 m above mean sea level. For altitudes >2000 m above mean sea level, refer to the data sheet.)
Ambient temperature (operation)	-40 °C ... 70 °C
Test voltage	2.5 kV
Rated insulation voltage	300 V _{rms}

Altitude range (≤ 3000 m)

Height range	> 2000 m ... 3000 m
Ambient temperature (operation)	-40 °C ... 60 °C
Test voltage	2.25 kV
Rated insulation voltage	150 V _{rms}

Altitude range (≤ 4000 m)

Height range	> 3000 m ... 4000 m
Ambient temperature (operation)	-40 °C ... 55 °C
Test voltage	2 kV
Rated insulation voltage	150 V _{rms}

Altitude range (≤ 5000 m)

Height range	> 4000 m ... 5000 m
Ambient temperature (operation)	-40 °C ... 49 °C
Test voltage	1.75 kV
Rated insulation voltage	150 V _{rms}

Approvals

CE

Certificate	CE-compliant
Note	and EN 61326

ATEX

Identification	⊕ II 3 G Ex ec ic IIC T4 Gc
Certificate	IBExU19ATEX1006 X

IECEX

Identification	Ex ec ic IIC T4 Gc
Certificate	IECEX IBE 19.0001 X

UL, USA/Canada

Identification	UL 61010 Listed
	Class I, Div. 2, Groups A, B, C, D T4

MACX MCR-TC-I-C - Temperature measuring transducer



1052459

<https://www.phoenixcontact.com/gb/products/1052459>

	Class I, Zone 2, Group IIC T4
--	-------------------------------

Shipbuilding approval

Certificate	DNV GL TAA00000AG
-------------	-------------------

Safety Integrity Level (SIL, IEC 61508)

Identification	2
Certificate	SEBS-A.150520/17, V2.0

Systematic Capability

Identification	2
----------------	---

INMETRO

Identification	Ex ec ic IIC T4 Gc
Certificate	DNV 21.0064 X

EAC Ex

Identification	Ex ec ic IIC T4 Gc
Certificate	BY/112 02.01 TP012 103.01 00082

Shipbuilding data

Temperature	B
Humidity	B
Vibration	A
EMC	B
Enclosure	Required protection according to the Rules shall be provided upon installation on board

EMC data

Electromagnetic compatibility	Conformance with EMC directive
Noise immunity	EN 61000-6-2
Note	When being exposed to interference, there may be minimal deviations.

Noise emission

Standards/regulations	EN 61000-6-4
-----------------------	--------------

Electromagnetic HF field

Designation	Electromagnetic RF field
Standards/regulations	EN 61000-4-3
Typical deviation from the measuring range final value	1 %

Fast transients (burst)

Designation	Fast transients (burst)
Standards/regulations	EN 61000-4-4
Typical deviation from the measuring range final value	1 %

Conducted interference

Designation	Conducted interferences
-------------	-------------------------

MACX MCR-TC-I-C - Temperature measuring transducer



1052459

<https://www.phoenixcontact.com/gb/products/1052459>

Standards/regulations	EN 61000-4-6
Typical deviation from the measuring range final value	1 %

Standards and regulations

Electrical isolation	3-way isolation
----------------------	-----------------

Mounting

Mounting type	DIN rail mounting
---------------	-------------------

MACX MCR-TC-I-C - Temperature measuring transducer

1052459

<https://www.phoenixcontact.com/gb/products/1052459>

Drawings

Dimensional drawing



MACX MCR-TC-I-C - Temperature measuring transducer

1052459

<https://www.phoenixcontact.com/gb/products/1052459>

Block diagram

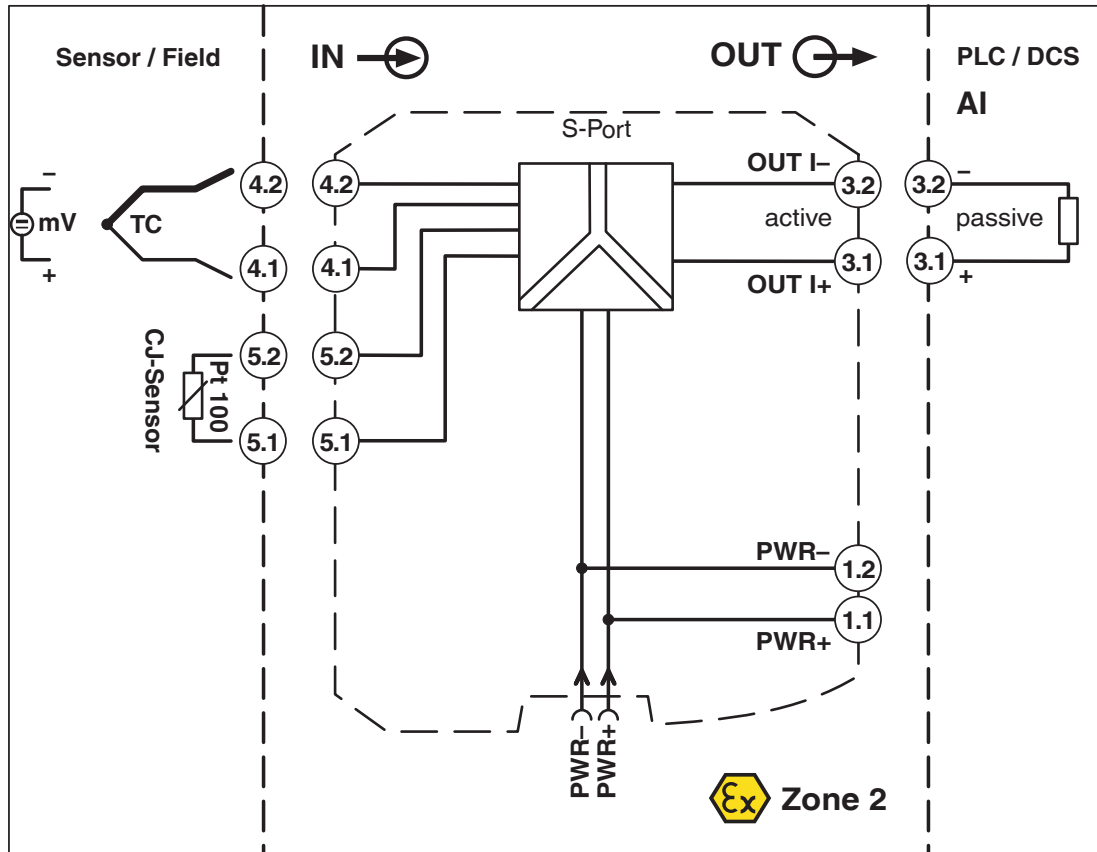

MACX MCR-TC-I-C - Temperature measuring transducer





1052459

<https://www.phoenixcontact.com/gb/products/1052459>

Approvals

To download certificates, visit the product detail page: <https://www.phoenixcontact.com/gb/products/1052459>

 **UL Listed**
Approval ID: E330267

 **cUL Listed**
Approval ID: FILE E 330267

 **Functional Safety**
Approval ID: SEBS-A.20170608

DNV
Approval ID: TAA00000AG

 **IECEx**
Approval ID: IECEx IBE 19.0001X

 **cUL Listed**
Approval ID: E199827

 **UL Listed**
Approval ID: E199827

INMETRO
Approval ID: DNV 21.0064 X

 **ATEX**
Approval ID: IBEXU 25 ATEX B008X

MACX MCR-TC-I-C - Temperature measuring transducer



1052459

<https://www.phoenixcontact.com/gb/products/1052459>

Classifications

ECLASS

ECLASS-13.0	27210129
ECLASS-15.0	27210129

ETIM

ETIM 10.0	EC002919
-----------	----------

UNSPSC

UNSPSC 21.0	41112100
-------------	----------

MACX MCR-TC-I-C - Temperature measuring transducer



1052459

<https://www.phoenixcontact.com/gb/products/1052459>

Environmental product compliance

EU RoHS

Fulfills EU RoHS substance requirements	Yes
Exemption	7(a), 7(c)-I

China RoHS

Environment friendly use period (EFUP)	EFUP-50
	An article-related China RoHS declaration table can be found in the download area for the respective article under "Manufacturer declaration". For all articles with EFUP-E, no China RoHS declaration table issued and required.

EU REACH SVHC

REACH candidate substance (CAS No.)	Lead(CAS: 7439-92-1)
	2,2',6,6'-tetrabromo-4,4'-isopropylidenediphenol(CAS: 79-94-7)

Phoenix Contact 2026 © - all rights reserved
<https://www.phoenixcontact.com>

PHOENIX CONTACT Ltd
Halesfield 13, Telford
Shropshire, TF7 4PG
01952 681700
info@phoenixcontact.co.uk