

PLC-OSC-110DC/300DC/ 1 - Solid-state relay module



2980694

<https://www.phoenixcontact.com/us/products/2980694>

Please be informed that the data shown in this PDF document is generated from our online catalog. Please find the complete data in the user documentation. Our general terms of use for downloads are valid.



PLC-INTERFACE, integrated solid-state relay, with screw connection, for mounting on NS 35/7,5 DIN rails, input: 110 V DC, output: 12 - 300 V DC/1 A

Your advantages

- Wear-free switching with no contact bounce
- Resistant to vibrations and shocks
- Protective circuit in input and output
- Status indicator
- DC voltage outputs up to 300 V DC/1 A
- Option of bridging adjacent modules

Commercial data

Item number	2980694
Packing unit	1 pc
Minimum order quantity	1 pc
Sales key	C461
Product key	CK6213
Catalog page	Page 408 (C-5-2019)
GTIN	4046356051439
Weight per piece (including packing)	37.46 g
Weight per piece (excluding packing)	34.31 g
Customs tariff number	85364900
Country of origin	DE

Technical data

Product properties

Product type	Solid-state relay module
Product family	PLC-INTERFACE
Application	With integrated solid-state relay
Operating mode	100% operating factor

Insulation characteristics

Insulation	Basic insulation
------------	------------------

Insulation characteristics: Standards/regulations

Insulation	Basic insulation
Overvoltage category	III
Pollution degree	2

Electrical properties

Maximum power dissipation for nominal condition	0.55 W
---	--------

Standards/regulations

Rated insulation voltage	300 V
Rated surge voltage	2.5 kV

Input data

Nominal input voltage U_N	110 V DC
Input voltage range in reference to U_N	0.8 ... 1.2
Input voltage range	88 V DC ... 132 V DC
Switching threshold "0" signal in reference to U_N	≤ 0.4
Switching threshold "1" signal in reference to U_N	≥ 0.8
Typical input current at U_N	5 mA
Typical response time	0.4 ms
Typical turn-off time	0.7 ms
Operating voltage display	Yellow LED
Protective circuit	Reverse polarity protection; Polarity protection diode
	Surge protection; Varistor
Transmission frequency	50 Hz

Output data

Designation	Output data
Contact switching type	1 N/O contact
Design of digital output	electronic
Output voltage range	12 V DC ... 300 V DC (Partition plate PLC-ATP must be installed for voltages larger than 250 V (L1, L2, L3) between identical terminal points in adjacent modules. Potential bridging is then carried out with FBST 8-PLC... or ...FBST 500...)
Limiting continuous current	1 A (see derating curve)

Voltage drop at max. limiting continuous current	< 500 mV
Protective circuit	Reverse polarity protection; Polarity protection diode
	Surge protection; Varistor

Connection data

Connection method	Screw connection
Stripping length	8 mm
Screw thread	M3
Conductor cross section rigid	0.14 mm ² ... 2.5 mm ²
Conductor cross section flexible	0.14 mm ² ... 2.5 mm ²
	0.2 mm ² ... 2.5 mm ² (Single ferrule)
	2x 0.5 mm ² ... 1.5 mm ² (TWIN ferrule)
Conductor cross section AWG	26 ... 14
Tightening torque	0.45 Nm ... 0.55 Nm (Usually these terminal blocks must be supported during conductor connection (held by one hand, supported on the housing))

Dimensions

Width	6.2 mm
Height	80 mm
Depth	95 mm

Material specifications

Flammability rating according to UL 94	V0 (Housing)
--	--------------

Environmental and real-life conditions

Ambient conditions

Ambient temperature (operation)	-25 °C ... 60 °C
Ambient temperature (storage/transport)	-40 °C ... 85 °C

Approvals

CE

Certificate	CE-compliant
-------------	--------------

UKCA

Certificate	UKCA-compliant
-------------	----------------

Shipbuilding approval

Certificate	TAE0000196
-------------	------------

Corrosive gas test

Identification	ISA-S71.04. G3 Harsh Group
	EN 60068-2-60

DNV GL data

Temperature	D
-------------	---

PLC-OSC-110DC/300DC/ 1 - Solid-state relay module



2980694

<https://www.phoenixcontact.com/us/products/2980694>

Humidity	A
Vibration	B/C
EMC	B
Enclosure	Required protection according to the Rules shall be provided upon installation on board

EMC data

Low Voltage Directive	Conformance with Low Voltage Directive
Electromagnetic compatibility	Conformance with EMC directive

Standards and regulations

Standards/regulations

Standards/regulations	IEC 60947-5-1
-----------------------	---------------

Mounting

Mounting type	DIN rail mounting
Assembly instructions	in rows with zero spacing
Mounting position	any

Drawings

Circuit diagram

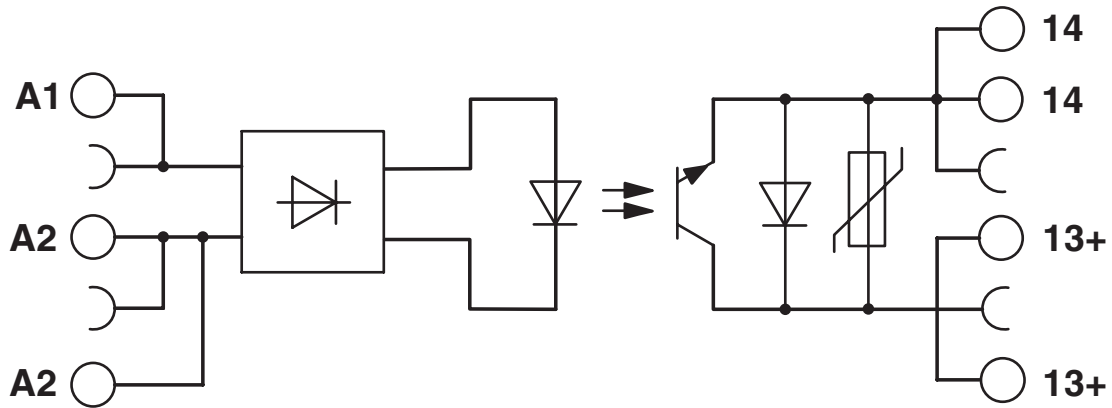

Diagram

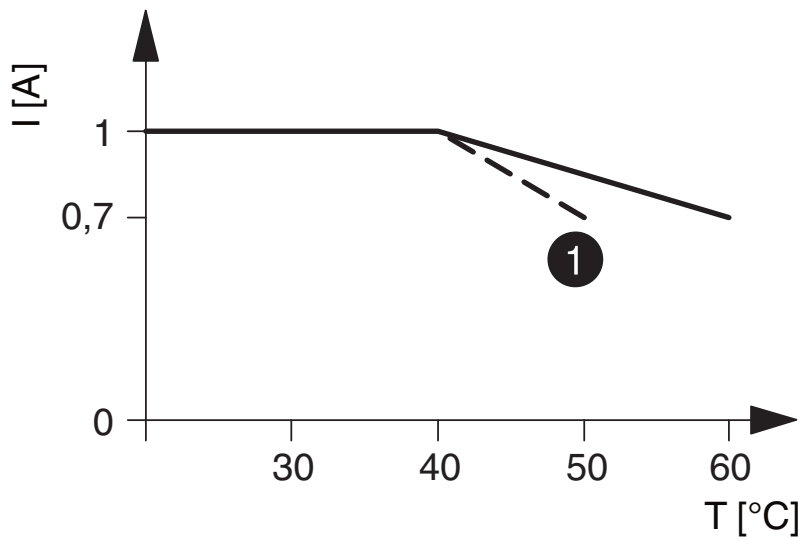

① Input voltages 220 V DC/230 V AC

The figure shows the derating curve for PLC-...300DC/1

2980694

<https://www.phoenixcontact.com/us/products/2980694>

Approvals

To download certificates, visit the product detail page: <https://www.phoenixcontact.com/us/products/2980694>



cUL Recognized
Approval ID: FILE E 238705



UL Recognized
Approval ID: FILE E 238705



EAC
Approval ID: TR_TS_D_00573_c



DNV GL
Approval ID: TAE0000196



EAC
Approval ID: RU*C-DE.*08.B.00010



UL Listed
Approval ID: FILE E 172140



cUL Listed
Approval ID: FILE E 172140

cULus Recognized

cULus Listed

2980694

<https://www.phoenixcontact.com/us/products/2980694>

Classifications

ECLASS

ECLASS-11.0	27371604
ECLASS-12.0	27371604
ECLASS-13.0	27371604

ETIM

ETIM 9.0	EC001504
----------	----------

UNSPSC

UNSPSC 21.0	39122300
-------------	----------

2980694

<https://www.phoenixcontact.com/us/products/2980694>

Environmental product compliance

REACH SVHC	Lead 7439-92-1
China RoHS	Environmentally Friendly Use Period = 50 years
	For information on hazardous substances, refer to the manufacturer's declaration available under "Downloads"

2980694

<https://www.phoenixcontact.com/us/products/2980694>

Accessories

 Note: Applying some accessories below might limit this product.

FBST 500-PLC RD - Continuous plug-in bridge

2966786

<https://www.phoenixcontact.com/us/products/2966786>

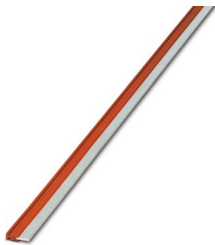

Continuous plug-in bridge, length: 500 mm, color: red

 Max. current carrying capacity: 32 A

FBST 500-PLC BU - Continuous plug-in bridge

2966692

<https://www.phoenixcontact.com/us/products/2966692>

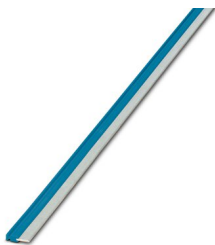

Continuous plug-in bridge, length: 500 mm, color: blue

 Max. current carrying capacity: 32 A

PLC-OSC-110DC/300DC/ 1 - Solid-state relay module



2980694

<https://www.phoenixcontact.com/us/products/2980694>

FBST 500-PLC GY - Continuous plug-in bridge

2966838

<https://www.phoenixcontact.com/us/products/2966838>



Continuous plug-in bridge, length: 500 mm, color: gray

 Max. current carrying capacity: 32 A

FBST 6-PLC RD - Single plug-in bridge

2966236

<https://www.phoenixcontact.com/us/products/2966236>

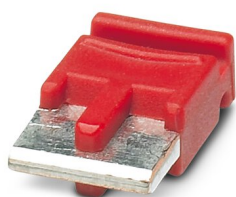

Single plug-in bridge, number of positions: 2, length: 6 mm, color: red

 Max. current carrying capacity: 6 A

PLC-OSC-110DC/300DC/ 1 - Solid-state relay module



2980694

<https://www.phoenixcontact.com/us/products/2980694>

FBST 6-PLC BU - Single plug-in bridge

2966812

<https://www.phoenixcontact.com/us/products/2966812>

Single plug-in bridge, number of positions: 2, length: 6 mm, color: blue



 Max. current carrying capacity: 6 A

FBST 6-PLC GY - Single plug-in bridge

2966825

<https://www.phoenixcontact.com/us/products/2966825>

Single plug-in bridge, number of positions: 2, length: 6 mm, color: gray



 Max. current carrying capacity: 6 A

PLC-OSC-110DC/300DC/ 1 - Solid-state relay module



2980694

<https://www.phoenixcontact.com/us/products/2980694>

FBST 8-PLC GY - Single plug-in bridge

2967688

<https://www.phoenixcontact.com/us/products/2967688>

Single plug-in bridge, number of positions: 2, length: 8 mm, color: gray



 Max. current carrying capacity: 6 A

FBST 14-PLC BK - Single plug-in bridge

2967691

<https://www.phoenixcontact.com/us/products/2967691>

Single plug-in bridge, number of positions: 2, length: 14 mm, color: black



 Max. current carrying capacity: 10 A

PLC-OSC-110DC/300DC/ 1 - Solid-state relay module



2980694

<https://www.phoenixcontact.com/us/products/2980694>

NS 35/ 7,5 PERF 2000MM - DIN rail perforated

0801733

<https://www.phoenixcontact.com/us/products/0801733>



DIN rail perforated, Pack of 25 (50 m), acc. to EN 60715, material: Steel, galvanized, passivated with a thick layer, Standard profile, color: silver

NS 35/ 7,5 UNPERF 2000MM - DIN rail, unperforated

0801681

<https://www.phoenixcontact.com/us/products/0801681>



DIN rail, unperforated, Pack of 25 (50 m), acc. to EN 60715, material: Steel, galvanized, passivated with a thick layer, Standard profile, color: silver

PLC-OSC-110DC/300DC/ 1 - Solid-state relay module



2980694

<https://www.phoenixcontact.com/us/products/2980694>

NS 35/ 7,5 WH PERF 2000MM - DIN rail perforated

1204119

<https://www.phoenixcontact.com/us/products/1204119>



DIN rail perforated, Pack of 25 (50 m), acc. to EN 60715, material: Steel, Galvanized, white passivated, Standard profile, color: silver

NS 35/ 7,5 WH UNPERF 2000MM-VPE 10 - DIN rail, unperforated

1204122

<https://www.phoenixcontact.com/us/products/1204122>



DIN rail, unperforated, Pack of 10 (20 m), acc. to EN 60715, material: Steel, Galvanized, white passivated, Standard profile, color: silver

PLC-OSC-110DC/300DC/ 1 - Solid-state relay module



2980694

<https://www.phoenixcontact.com/us/products/2980694>

NS 35/ 7,5 AL UNPERF 2000MM - DIN rail, unperforated

0801704

<https://www.phoenixcontact.com/us/products/0801704>



DIN rail, unperforated, Pack of 25 (50 m), acc. to EN 60715, material: Aluminum, uncoated, Standard profile, color: silver

NS 35/ 7,5 ZN PERF 2000MM - DIN rail perforated

1206421

<https://www.phoenixcontact.com/us/products/1206421>



DIN rail perforated, Pack of 25 (50 m), acc. to EN 60715, material: Steel, galvanized, Standard profile, color: silver

PLC-OSC-110DC/300DC/ 1 - Solid-state relay module



2980694

<https://www.phoenixcontact.com/us/products/2980694>

NS 35/ 7,5 ZN UNPERF 2000MM - DIN rail, unperforated

1206434

<https://www.phoenixcontact.com/us/products/1206434>



DIN rail, unperforated, Pack of 25 (50 m), acc. to EN 60715, material: Steel, galvanized, Standard profile, color: silver

NS 35/ 7,5 CU UNPERF 2000MM-VPE 10 - DIN rail, unperforated

0801762

<https://www.phoenixcontact.com/us/products/0801762>



DIN rail, unperforated, Pack of 10 (20 m), acc. to EN 60715, material: Copper, uncoated, Standard profile, color: copper-colored

PLC-OSC-110DC/300DC/ 1 - Solid-state relay module



2980694

<https://www.phoenixcontact.com/us/products/2980694>

NS 35/ 7,5 CAP - End cap

1206560

<https://www.phoenixcontact.com/us/products/1206560>

DIN rail end piece, for DIN rail NS 35/7.5



NS 35/15 PERF 2000MM - DIN rail perforated

1201730

<https://www.phoenixcontact.com/us/products/1201730>



DIN rail perforated, Pack of 25 (50 m), similar to EN 60715, material: Steel, galvanized, passivated with a thick layer, Standard profile, color: silver

PLC-OSC-110DC/300DC/ 1 - Solid-state relay module



2980694

<https://www.phoenixcontact.com/us/products/2980694>

NS 35/15 UNPERF 2000MM - DIN rail, unperforated

1201714

<https://www.phoenixcontact.com/us/products/1201714>



DIN rail, unperforated, Pack of 25 (50 m), similar to EN 60715, material: Steel, galvanized, passivated with a thick layer, Standard profile, color: silver

NS 35/15 WH PERF 2000MM - DIN rail perforated

0806602

<https://www.phoenixcontact.com/us/products/0806602>



DIN rail perforated, Pack of 25 (50 m), similar to EN 60715, material: Steel, Galvanized, white passivated, Standard profile, color: white

PLC-OSC-110DC/300DC/ 1 - Solid-state relay module



2980694

<https://www.phoenixcontact.com/us/products/2980694>

NS 35/15 WH UNPERF 2000MM-VPE 10 - DIN rail, unperforated

1204135

<https://www.phoenixcontact.com/us/products/1204135>



DIN rail, unperforated, Pack of 10 (20 m), similar to EN 60715, material: Steel, Galvanized, white passivated, Standard profile, color: silver

NS 35/15 AL UNPERF 2000MM - DIN rail, unperforated

1201756

<https://www.phoenixcontact.com/us/products/1201756>



DIN rail, unperforated, similar to EN 60715, material: Aluminum, uncoated, Standard profile, color: silver

PLC-OSC-110DC/300DC/ 1 - Solid-state relay module



2980694

<https://www.phoenixcontact.com/us/products/2980694>

NS 35/15 ZN PERF 2000MM - DIN rail perforated

1206599

<https://www.phoenixcontact.com/us/products/1206599>



DIN rail perforated, Pack of 25 (50 m), similar to EN 60715, material: Steel, galvanized, Standard profile, color: silver

NS 35/15 ZN UNPERF 2000MM - DIN rail, unperforated

1206586

<https://www.phoenixcontact.com/us/products/1206586>



DIN rail, unperforated, Pack of 25 (50 m), similar to EN 60715, material: Steel, galvanized, Standard profile, color: silver

PLC-OSC-110DC/300DC/ 1 - Solid-state relay module



2980694

<https://www.phoenixcontact.com/us/products/2980694>

NS 35/15 CU UNPERF 2000MM-VPE 10 - DIN rail, unperforated

1201895

<https://www.phoenixcontact.com/us/products/1201895>



DIN rail, unperforated, Pack of 10 (20 m), similar to EN 60715, material: Copper, uncoated, Standard profile, color: copper-colored

NS 35/15 CAP - End cap

1206573

<https://www.phoenixcontact.com/us/products/1206573>

DIN rail end piece, for DIN rail NS 35/15



PLC-OSC-110DC/300DC/ 1 - Solid-state relay module



2980694

<https://www.phoenixcontact.com/us/products/2980694>

NS 35/15-2,3 UNPERF 2000MM-VPE 10 - DIN rail, unperforated

1201798

<https://www.phoenixcontact.com/us/products/1201798>



DIN rail, unperforated, Pack of 10 (20 m), acc. to EN 60715, material: Steel, galvanized, passivated with a thick layer, Standard profile 2.3 mm, color: silver

PLC-ATP BK - Separating plate

2966841

<https://www.phoenixcontact.com/us/products/2966841>



Separating plate, 2 mm thick, required at the start and end of a PLC terminal strip. Furthermore, it is used for: visual separation of groups, safe isolation of different voltages of neighboring PLC relays in acc. with DIN VDE 0106-101, isolation

PLC-OSC-110DC/300DC/ 1 - Solid-state relay module



2980694

<https://www.phoenixcontact.com/us/products/2980694>

PLC-ESK GY - Power terminal block

2966508

<https://www.phoenixcontact.com/us/products/2966508>



Power terminal block, for the input of up to four potentials, for mounting on NS 35/7.5

SZF 1-0,6X3,5 - Screwdriver

1204517

<https://www.phoenixcontact.com/us/products/1204517>



Actuation tool, for ST terminal blocks, also suitable for use as a bladed screwdriver, size: 0.6 x 3.5 x 100 mm, 2-component grip, with non-slip grip

Phoenix Contact 2023 © - all rights reserved
<https://www.phoenixcontact.com>

Phoenix Contact USA
586 Fulling Mill Road
Middletown, PA 17057, United States
(+717) 944-1300
info@phoenixcon.com