

DEK-OE- 12DC/ 48DC/100 - Solid-state relay terminal block



2964487

<https://www.phoenixcontact.com/us/products/2964487>

Please be informed that the data shown in this PDF document is generated from our online catalog. Please find the complete data in the user documentation. Our general terms of use for downloads are valid.



Input solid-state relay terminal block, input: 12 V DC, output: 3 - 48 V DC/100 mA, terminal block width: 6.2 mm

Your advantages

- EB-DIK insertion bridges
- Actuator version available
- Labeling and mounting with user-friendly modular terminal blocks
- Wear-free switching up to 48 V DC/100 mA
- Integrated output protective circuit
- Zero voltage switch at AC output
- Integrated input circuit
- Electrical isolation between input and output at up to 2.5 kVrms
- Status indicator

Commercial data

Item number	2964487
Packing unit	1 pc
Minimum order quantity	1 pc
Sales key	C460
Product key	CK61D1
Catalog page	Page 442 (C-5-2019)
GTIN	4017918125141
Weight per piece (including packing)	20.57 g
Weight per piece (excluding packing)	20.5 g
Customs tariff number	85364190
Country of origin	CN

DEK-OE- 12DC/ 48DC/100 - Solid-state relay terminal block



2964487

<https://www.phoenixcontact.com/us/products/2964487>

Technical data

Notes

General	Use of EB 80-DIK... bridges in the DEK terminal blocks: Absorption of humidity from the ambient air as well as an unfavorable tolerance between a larger number of DEK terminal blocks and the EB 80-DIK... bridge may cause (minor) expansion of the DEK housing. When the EB 80-DIK... bridges are used, therefore, it is recommended that these be disconnected after about 10 to 12 DEK terminal blocks and a wire bridge to the next DEK terminal block be inserted in their place.
---------	---

Product properties

Product type	Solid-state relay module
Product family	DEK
Application	Output function
Operating mode	100% operating factor

Insulation characteristics

Insulation	Basic insulation
------------	------------------

Insulation characteristics: Standards/regulations

Insulation	Basic insulation
Overvoltage category	III
Pollution degree	2

Electrical properties

Test voltage (Input/output)	2.5 kV AC (Input/output)
-----------------------------	--------------------------

Input data

Nominal input voltage U_N	12 V DC
Input voltage range in reference to U_N	0.8 ... 1.2
Input voltage range	9.6 V DC ... 14.4 V DC
Switching threshold "0" signal in reference to U_N	≤ 0.4
Switching threshold "1" signal in reference to U_N	≥ 0.8
Typical input current at U_N	11 mA
Typical response time	20 μ s
Typical turn-off time	200 μ s
Operating voltage display	Yellow LED
Protective circuit	Reverse polarity protection
Transmission frequency	300 Hz

Output data

Contact switching type	1 N/O contact
Design of digital output	electronic
Output voltage range	3 V DC ... 48 V DC
Limiting continuous current	100 mA

DEK-OE- 12DC/ 48DC/100 - Solid-state relay terminal block



2964487

<https://www.phoenixcontact.com/us/products/2964487>

Voltage drop at max. limiting continuous current	≤ 0.9 V
Output circuit	2-conductor floating, 3-conductor ground-referenced
Protective circuit	Reverse polarity protection; Polarity protection diode Freewheeling diode; Freewheeling diode
Output resistor	approx. 22 kΩ (for 3-conductor operation)

Connection data

Connection method	Screw connection
Stripping length	8 mm
Screw thread	M3
Conductor cross section rigid	0.2 mm ² ... 2.5 mm ²
Conductor cross section flexible	0.2 mm ² ... 2.5 mm ²
Conductor cross section AWG	24 ... 14
Tightening torque	0.5 Nm

Dimensions

Width	6.2 mm
Height	80 mm
Depth	56 mm

Environmental and real-life conditions

Ambient conditions

Ambient temperature (operation)	-20 °C ... 60 °C
Ambient temperature (storage/transport)	-20 °C ... 70 °C

Standards and regulations

Standards/regulations

Standards/regulations	IEC 60947-5-1
-----------------------	---------------

Mounting

Mounting type	DIN rail mounting
Assembly instructions	in rows with zero spacing
Mounting position	any

DEK-OE- 12DC/ 48DC/100 - Solid-state relay terminal block



2964487

<https://www.phoenixcontact.com/us/products/2964487>

Drawings

Circuit diagram

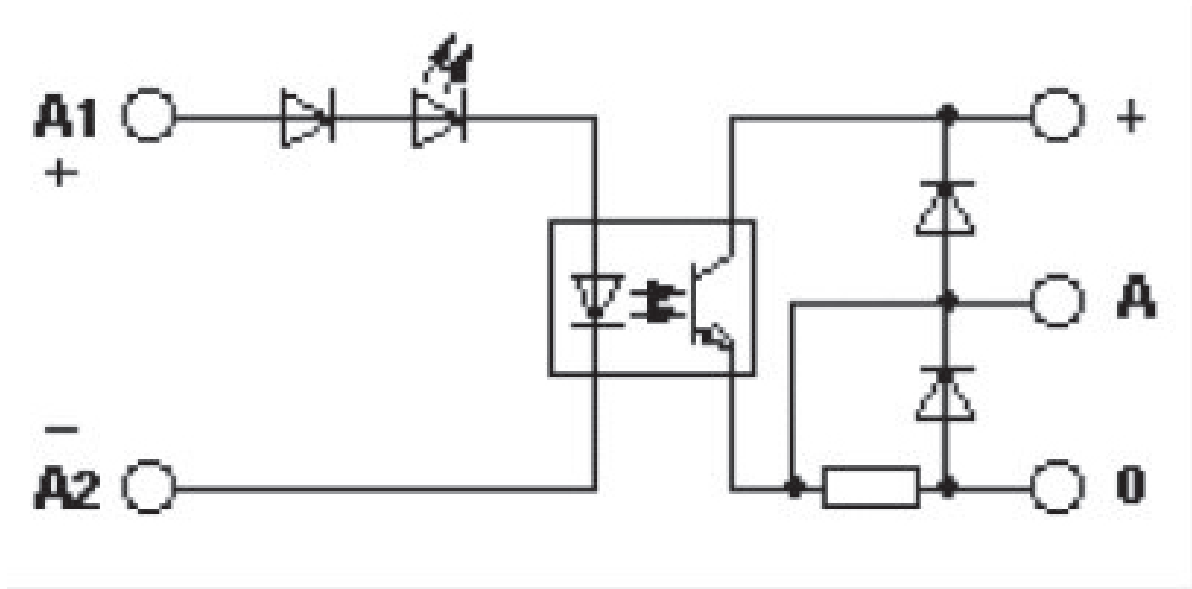

DEK-OE- 12DC/ 48DC/100 - Solid-state relay terminal block



2964487

<https://www.phoenixcontact.com/us/products/2964487>

Approvals

🔗 To download certificates, visit the product detail page: <https://www.phoenixcontact.com/us/products/2964487>



EAC

Approval ID: TR_TS_D_00573_c



EAC

Approval ID: RU*C-DE.*08.B.00010

DEK-OE- 12DC/ 48DC/100 - Solid-state relay terminal block



2964487

<https://www.phoenixcontact.com/us/products/2964487>

Classifications

ECLASS

ECLASS-11.0	27371604
ECLASS-12.0	27371604
ECLASS-13.0	27371604

ETIM

ETIM 9.0	EC001504
----------	----------

UNSPSC

UNSPSC 21.0	39122300
-------------	----------

DEK-OE- 12DC/ 48DC/100 - Solid-state relay terminal block



2964487

<https://www.phoenixcontact.com/us/products/2964487>

Environmental product compliance

REACH SVHC	Lead 7439-92-1
	Hexahydromethylphthalic anhydride
China RoHS	Environmentally Friendly Use Period = 50 years
	For information on hazardous substances, refer to the manufacturer's declaration available under "Downloads"

DEK-OE- 12DC/ 48DC/100 - Solid-state relay terminal block

2964487

<https://www.phoenixcontact.com/us/products/2964487>

Accessories

i Note: Applying some accessories below might limit this product.

EB 2- DIK RD - Insertion bridge

2716693

<https://www.phoenixcontact.com/us/products/2716693>



Insertion bridge, pitch: 6.15 mm, number of positions: 2, color: red

i Max. current carrying capacity: 26 A

EB 3- DIK RD - Insertion bridge

2716745

<https://www.phoenixcontact.com/us/products/2716745>



Insertion bridge, pitch: 6.15 mm, number of positions: 3, color: red

i Max. current carrying capacity: 26 A

DEK-OE- 12DC/ 48DC/100 - Solid-state relay terminal block



2964487

<https://www.phoenixcontact.com/us/products/2964487>

EB 4- DIK RD - Insertion bridge

2716758

<https://www.phoenixcontact.com/us/products/2716758>



Insertion bridge, pitch: 6.15 mm, number of positions: 4, color: red

 Max. current carrying capacity: 26 A

EB 5- DIK RD - Insertion bridge

2716761

<https://www.phoenixcontact.com/us/products/2716761>



Insertion bridge, pitch: 6.15 mm, number of positions: 5, color: red

 Max. current carrying capacity: 26 A

DEK-OE- 12DC/ 48DC/100 - Solid-state relay terminal block

2964487

<https://www.phoenixcontact.com/us/products/2964487>

EB 10- DIK RD - Insertion bridge

2716774

<https://www.phoenixcontact.com/us/products/2716774>



Insertion bridge, pitch: 6.15 mm, number of positions: 10, color: red

 Max. current carrying capacity: 26 A

EB 80- DIK RD - Insertion bridge

2715953

<https://www.phoenixcontact.com/us/products/2715953>



Insertion bridge, pitch: 6.2 mm, number of positions: 80, color: red

 Max. current carrying capacity: 26 A

DEK-OE- 12DC/ 48DC/100 - Solid-state relay terminal block



2964487

<https://www.phoenixcontact.com/us/products/2964487>

EB 5- DIK BU - Insertion bridge

2716677

<https://www.phoenixcontact.com/us/products/2716677>



Insertion bridge, pitch: 6.15 mm, number of positions: 5, color: blue

 Max. current carrying capacity: 26 A

EB 10- DIK BU - Insertion bridge

2716680

<https://www.phoenixcontact.com/us/products/2716680>



Insertion bridge, pitch: 6.15 mm, number of positions: 10, color: blue

 Max. current carrying capacity: 26 A

DEK-OE- 12DC/ 48DC/100 - Solid-state relay terminal block



2964487

<https://www.phoenixcontact.com/us/products/2964487>

EB 80- DIK BU - Insertion bridge

2715940

<https://www.phoenixcontact.com/us/products/2715940>

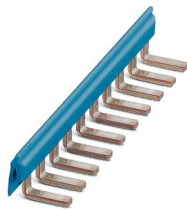

Insertion bridge, pitch: 6.2 mm, number of positions: 80, color: blue

 Max. current carrying capacity: 26 A

D-DEK 1,5 GN - Separating plate

2716949

<https://www.phoenixcontact.com/us/products/2716949>

Cover for setting the end of a terminal row, color: green



DEK-OE- 12DC/ 48DC/100 - Solid-state relay terminal block



2964487

<https://www.phoenixcontact.com/us/products/2964487>

ZB 6:UNBEDRUCKT - Zack marker strip

1051003

<https://www.phoenixcontact.com/us/products/1051003>



Zack marker strip, Strip, white, unlabeled, can be labeled with: PLOTMARK, CMS-P1-PLOTTER, mounting type: snapped, for terminal block width: 6.2 mm, lettering field size: 6.15 x 10.5 mm, Number of individual labels: 10

ZB 6,LGS:FORTL.ZAHLEN - Zack marker strip

1051016

<https://www.phoenixcontact.com/us/products/1051016>



Zack marker strip, Strip, white, labeled, can be labeled with: CMS-P1-PLOTTER, printed horizontally: consecutive numbers 1 ... 10, 11 ... 20, etc. up to 491 ... 500, mounting type: snapped, for terminal block width: 6.2 mm, lettering field size: 6.15 x 10.5 mm, Number of individual labels: 10

DEK-OE- 12DC/ 48DC/100 - Solid-state relay terminal block



2964487

<https://www.phoenixcontact.com/us/products/2964487>

ZB 6/WH-100:UNBEDRUCKT - Zack marker strip

5060935

<https://www.phoenixcontact.com/us/products/5060935>



Zack marker strip, Strip, white, unlabeled, can be labeled with: PLOTMARK, CMS-P1-PLOTTER, mounting type: snapped, for terminal block width: 6.2 mm, lettering field size: 6.15 x 10.5 mm, Number of individual labels: 1000

DIKD 1,5 - Sensor/actuator terminal block

2715979

<https://www.phoenixcontact.com/us/products/2715979>

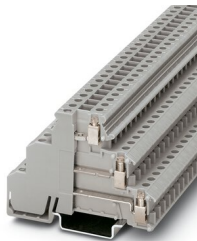

Sensor/actuator terminal block, nom. voltage: 250 V, nominal current: 24 A, connection method: Screw connection, 1st, 2nd and 3rd level, Rated cross section: 2.5 mm², cross section: 0.2 mm² - 4 mm², mounting type: NS 35/7,5, NS 35/15, color: gray

Phoenix Contact 2023 © - all rights reserved
<https://www.phoenixcontact.com>

Phoenix Contact USA
586 Fulling Mill Road
Middletown, PA 17057, United States
(+717) 944-1300
info@phoenixcon.com