

# SAC-5P-M12MS/ 1,5-PUR SH - Sensor/actuator cable



1682728

<https://www.phoenixcontact.com/us/products/1682728>

Please be informed that the data shown in this PDF document is generated from our online catalog. Please find the complete data in the user documentation. Our general terms of use for downloads are valid.



Sensor/actuator cable, 5-position, PUR halogen-free, black-gray RAL 7021, shielded (Advanced Shielding Technology), Plug straight M12, coding: A, on free cable end, cable length: 1.5 m

## Your advantages

- Easy and safe: 100 % electrically tested plug-in components
- Reliable signal transmission – 360° shielding in environments with electromagnetic interference

## Commercial data

Item number	1682728
Packing unit	1 pc
Minimum order quantity	1 pc
Sales key	BF03
Product key	AF1CKA
Catalog page	Page 204 (C-2-2019)
GTIN	4017918169039
Weight per piece (including packing)	83.2 g
Weight per piece (excluding packing)	78.8 g
Customs tariff number	85444290
Country of origin	PL

1682728

<https://www.phoenixcontact.com/us/products/1682728>

## Technical data

### Product properties

Product type	Sensor/actuator cable
Application	Standard
Number of positions	5
No. of cable outlets	1
Shielded	yes
Coding	A

### Insulation characteristics

Overvoltage category	II
Degree of pollution	3

### Material specifications

Flammability rating according to UL 94	HB
Seal material	NBR
Material of grip body	TPU, hardly inflammable, self-extinguishing
Contact material	CuSn
Contact surface material	Ni/Au
Contact carrier material	TPU GF
Material for screw connection	Zinc die-cast, nickel-plated

### Electrical properties

Insulation resistance	$\geq 100 \text{ M}\Omega$
Nominal voltage $U_N$	48 V AC
	60 V DC
Nominal current $I_N$	4 A

### Mechanical properties

#### Mechanical data

Insertion/withdrawal cycles	$\geq 100$
-----------------------------	------------

### Signaling

Status display	no
Status display present	no

### Connection data

#### Conductor connection

Tightening torque	0.4 Nm (M12 connector)
-------------------	------------------------

### Connector

#### Connection 1

# SAC-5P-M12MS/ 1,5-PUR SH - Sensor/actuator cable



1682728

<https://www.phoenixcontact.com/us/products/1682728>

Type	Plug straight M12
Number of positions	5
Coding type	A

## Connection 2

Type	free cable end
------	----------------

## Cable/line

Cable length	1.5 m
--------------	-------

## PUR halogen-free black [PUR]

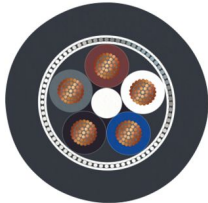
Dimensional drawing	
Cable weight	43 kg/km
UL AWM Style	20549 / 10493 (80°C/300 V)
Number of positions	5
Shielded	yes
Cable type	PUR halogen-free black [PUR]
Conductor structure signal line	42x 0.10 mm
AWG signal line	22
Conductor cross section	5x 0.34 mm <sup>2</sup> (Signal line)
Wire diameter incl. insulation	1.27 mm ±0.02 mm (Signal line)
External cable diameter	5.25 mm ±0.2 mm
Outer sheath, material	PUR
External sheath, color	black-gray RAL 7021
Conductor material	Bare Cu litz wires
Material wire insulation	PP
Single wire, color	brown, white, blue, black, gray
Thickness, insulation	≥ 0.21 mm
Thickness, outer sheath	approx. 0.50 mm
Overall twist	5 wires around filler to the core
Optical shield covering	80 %
Max. conductor resistance	max. 57 Ω/km (at 20 °C)
Insulation resistance	70 GΩ*km (at 20 °C)
Nominal voltage, cable	300 V (at 20 °C)
Test voltage Core/Core	3000 V (at 20 °C)
Smallest bending radius, fixed installation	26 mm
Smallest bending radius, movable installation	52 mm (up to +60 °C)
Dynamic load capacity (bending)	Max. bending cycles: 10000000, Bending radius: 52 mm,

# SAC-5P-M12MS/ 1,5-PUR SH - Sensor/actuator cable



1682728

<https://www.phoenixcontact.com/us/products/1682728>

	Traversing path: 10 m, Traversing rate: 3 m/s, Acceleration: 10 m/s <sup>2</sup>
Dynamic load capacity (torsion)	Torsion: ±180 °/m, Torsion cycles: ≥2000000, Torsional frequency: 35 cycles/min.
Halogen-free	in accordance with DIN VDE 0472 part 815
	in accordance with DIN EN 50267-2-1
Flame resistance	in accordance with UL 758/1581 FT2
	DIN EN 60332-2-2 (20 s)
Resistance to oil	in accordance with DIN EN 60811-2-1
Other resistance	Highly resistant to acids, alkaline solutions and solvents
	hydrolysis and microbe resistant
	Resistant to salt water
	partly UV-resistant (in accordance with DIN EN ISO 4892-2-A)
Special properties	abrasion-resistant
	Flexible cable conduit capable
	Silicone-free
	Free of substances which would hinder coating with paint or varnish
Ambient temperature (operation)	Low adhesion surface
	-40 °C ... 80 °C (cable, fixed installation)
	-25 °C ... 80 °C (Cable, flexible installation)

## Environmental and real-life conditions

### Ambient conditions

Degree of protection	IP65
	IP67
Ambient temperature (operation)	-25 °C ... 90 °C (Plug / socket)

## Standards and regulations

### M12

Standard designation	M12 connector
Standards/specifications	IEC 61076-2-101

## Drawings

Dimensional drawing

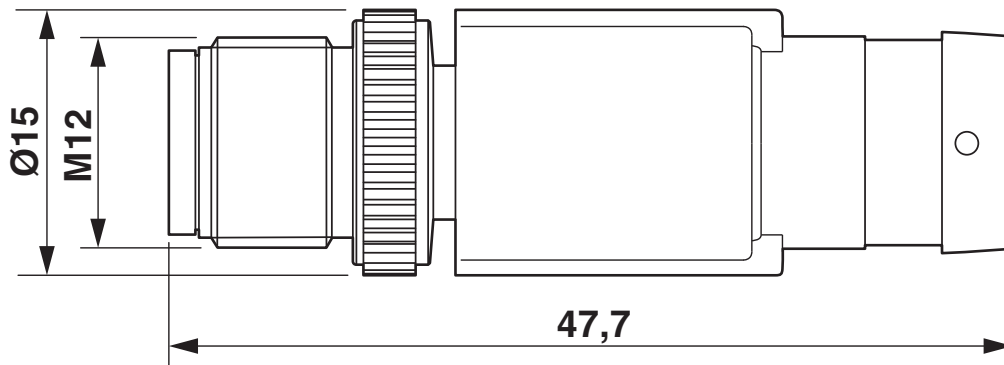

Plug, M12 x 1, straight, shielded

Schematic diagram

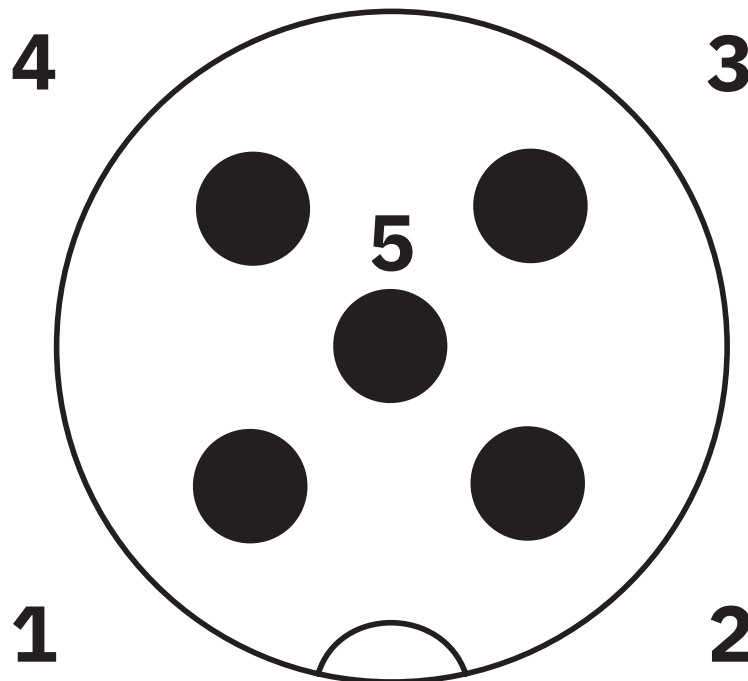

Pin assignment M12 male connector, 5-pos., A-coded, male side

Circuit diagram

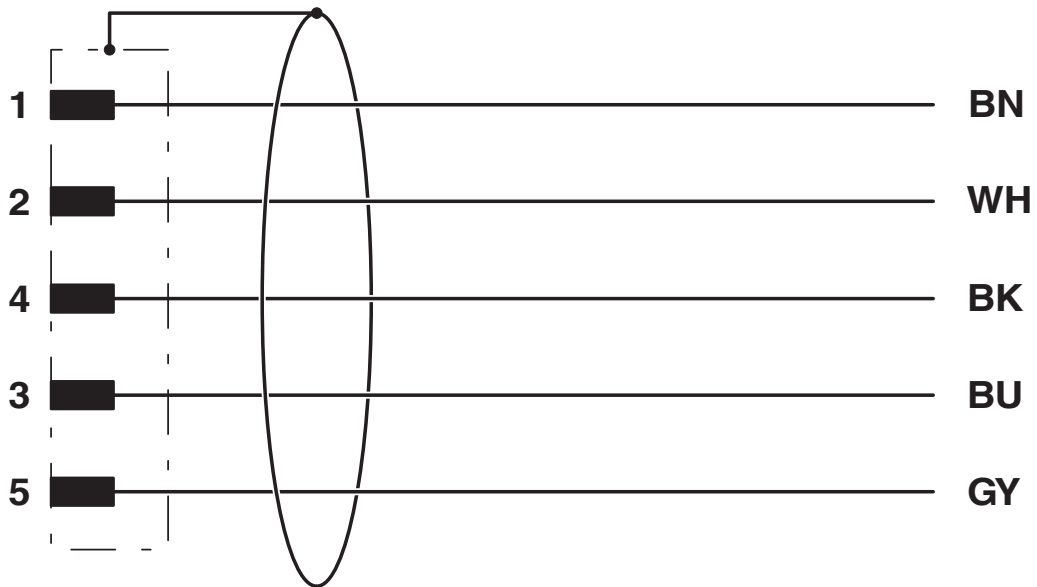

Contact assignment of the M12 plug

# SAC-5P-M12MS/ 1,5-PUR SH - Sensor/actuator cable





1682728

<https://www.phoenixcontact.com/us/products/1682728>

## Approvals

To download certificates, visit the product detail page: <https://www.phoenixcontact.com/us/products/1682728>

 <b>UL Listed</b> Approval ID: FILE E 221474				
	Nominal voltage $U_N$	Nominal current $I_N$	Cross section AWG	Cross section $mm^2$
	125 V	4 A	-	-

 <b>cUL Listed</b> Approval ID: FILE E 221474				
	Nominal voltage $U_N$	Nominal current $I_N$	Cross section AWG	Cross section $mm^2$
	125 V	4 A	-	-

 <b>EAC-RoHS</b> Approval ID: RU D-DE.HB35.B.00387	
---	--

<b>cULus Listed</b>
---------------------

# SAC-5P-M12MS/ 1,5-PUR SH - Sensor/actuator cable



1682728

<https://www.phoenixcontact.com/us/products/1682728>

## Classifications

### ECLASS

ECLASS-11.0	27060311
ECLASS-12.0	27060311
ECLASS-13.0	27060311

### ETIM

ETIM 9.0	EC001855
----------	----------

### UNSPSC

UNSPSC 21.0	26121600
-------------	----------



# SAC-5P-M12MS/ 1,5-PUR SH - Sensor/actuator cable



1682728

<https://www.phoenixcontact.com/us/products/1682728>

## Environmental product compliance

### EU RoHS

Fulfills EU RoHS substance requirements	Yes, No exemptions
---	--------------------

### China RoHS

Environment friendly use period (EFUP)	EFUP-E
	No hazardous substances above the limits

### EU REACH SVHC

REACH candidate substance (CAS No.)	No substance above 0.1 wt%
-------------------------------------	----------------------------

### EF3.0 Climate Change

CO2e kg	1.471 kg CO2e
---------	---------------

Phoenix Contact 2025 © - all rights reserved  
<https://www.phoenixcontact.com>

Phoenix Contact USA  
586 Fulling Mill Road  
Middletown, PA 17057, United States  
(+717) 944-1300  
[info@phoenixcon.com](mailto:info@phoenixcon.com)