

MACX MCR-EX-SL-RPSS-2I-2I-SP - Repeater power supply



2924676

<https://www.phoenixcontact.com/us/products/2924676>

Please be informed that the data shown in this PDF document is generated from our online catalog. Please find the complete data in the user documentation. Our general terms of use for downloads are valid.



Ex i measuring transducer repeater power supply, 2-channel, HART-transparent. Supplies Ex i 2-conductor measuring transducers and transmits the 4...20 mA signal from the Ex area to the safe area. 5-way electrical isolation, Push-in connection, up to SIL 3, PL.

Your advantages

- 2-channel
- 4 mA ... 20 mA input, intrinsically safe, [Ex ia], powered
- Output 4 mA ... 20 mA, active
- HART-compatible
- Error indication according to NAMUR NE 43
- Up to SIL 3 according to IEC/EN 61508
- 5-way electrical isolation
- Power supply possible via DIN rail connector
- Installation in Ex zone 2 permitted
- Plug-in connection terminals, push-in connection technology
- Housing width: 12.5 mm
- Minimal power dissipation
- High transmission accuracy

Commercial data

Item number	2924676
Packing unit	1 pc
Minimum order quantity	1 pc
Sales key	C430
Product key	CK3111
Catalog page	Page 144 (C-5-2019)
GTIN	4046356665483
Weight per piece (including packing)	239.5 g
Weight per piece (excluding packing)	212.7 g
Customs tariff number	85437090
Country of origin	DE

MACX MCR-EX-SL-RPSS-2I-2I-SP - Repeater power supply



2924676

<https://www.phoenixcontact.com/us/products/2924676>

Technical data

Notes

Utilization restriction

EMC note	EMC: class A product, see manufacturer's declaration in the download area
----------	---

Product properties

Product type	Repeater power supplies
Product family	MACX Analog
Application	Analog IN
No. of channels	2
Type	Ex i signal conditioners with SIL and PL Functional Safety

Electrical properties

No. of channels	2
Electrical isolation	5-way isolation
Electrical isolation between input and output	yes
Signal transmission behavior	In = Out
Step response (10-90%)	< 1.3 ms (for 4 mA ... 20 mA step)
Maximum temperature coefficient	< 0.01 %/K
Maximum transmission error	< 0.1 % (of final value)
Transmission error, typical	< 0.05 % (of final value)

Electrical isolation

Overvoltage category	II
Pollution degree	2

Electrical isolation Input/output, power supply IEC/EN 61010-1

Standards/regulations	IEC/EN 61010-1
Rated insulation voltage	300 V _{rms}
Test voltage	2.5 kV AC (50 Hz, 60 s)
Insulation	Safe isolation

Electrical isolation Input/output IEC/EN 60079-11

Standards/regulations	IEC/EN 60079-11
Rated insulation voltage	265 V _{rms}

Electrical isolation Input/power supply IEC/EN 60079-11

Standards/regulations	IEC/EN 60079-11
Rated insulation voltage	265 V _{rms}

Electrical isolation Output 1/output 2/ power supply

Test voltage	1.5 kV AC (50 Hz, 60 s)
--------------	-------------------------

Supply

MACX MCR-EX-SL-RPSS-2I-2I-SP - Repeater power supply



2924676

<https://www.phoenixcontact.com/us/products/2924676>

Nominal supply voltage	24 V DC -20 % ... +25 %
Supply voltage range	19.2 V DC ... 30 V DC
Max. current consumption	< 100 mA (24 V DC / 20 mA)
Power dissipation	< 1.4 W (24 V DC / 20 mA)
Power consumption	≤ 2.4 W

Input data

Signal: Current

Description of the input	Intrinsically safe
Number of inputs	2
Current input signal	4 mA ... 20 mA
Transmitter supply voltage	> 16 V (20 mA)
Underload/overload signal range	0 mA ... 24 mA

Output data

Signal: Current

Output description	Current output
Number of outputs	2
Current output signal	4 mA ... 20 mA (active)
Load/output load current output	≤ 450 Ω (20 mA)
	≤ 375 Ω (24 mA)
Output behavior in the event of an error	< 3.6 mA (In the event of cable break at the input (as per NE 43))
	> 22.5 mA (In the event of cable short circuit at the input (as per NE 43))
Underload/overload signal range	0 mA ... 24 mA

Connection data

Connection method	Push-in connection
Stripping length	10 mm
Conductor cross section rigid	0.2 mm ² ... 2.5 mm ²
Conductor cross section flexible	0.2 mm ² ... 2.5 mm ²
Conductor cross section flexible (2 conductors with same cross section)	0.25 mm ² ... 0.34 mm ² (TWIN ferrule without plastic sleeve)
	0.5 mm ² ... 1.5 mm ² (TWIN ferrule with plastic sleeve)
Conductor cross section AWG	24 ... 14
	24 ... 22 (TWIN ferrule without plastic sleeve)
	20 ... 16 (TWIN ferrule with plastic sleeve)

Ex data

Ex installation (EPL)	Gc
	Div. 2
Ex i circuits (EPL)	Ga
	Da
	Ma
	Div. 1

MACX MCR-EX-SL-RPSS-2I-2I-SP - Repeater power supply



2924676

<https://www.phoenixcontact.com/us/products/2924676>

Safety data

Max. output voltage U_o	25.2 V
Max. output current I_o	93 mA
Max. output power P_o	587 mW
Safety-related maximum voltage U_m	253 V AC
	125 V DC
I (simple circuit): Max. external inductivity L_o / Max. external capacitance C_o	40 mH / 4.8 μ F
IIA (simple circuit): Max. external inductivity L_o / Max. external capacitance C_o	26 mH / 2.9 μ F
IIB (simple circuit): Max. external inductivity L_o / Max. external capacitance C_o	14 mH / 820 nF
IIC (simple circuit): Max. external inductivity L_o / Max. external capacitance C_o	3 mH / 107 nF
IIA (mixed circuit): Max. external inductivity L_o / Max. external capacitance C_o	26 mH / 470 nF, 20 mH / 570 nF, 1 mH / 630 nF, 0.5 mH / 720 nF, 0.1 mH / 1.1 μ F, 0.005 mH / 2.9 μ F
IIB/III (mixed circuit): Max. external inductivity L_o / Max. external capacitance C_o	16 mH / 370 nF, 500 μ H / 510 nF, 200 μ H / 660 nF, 100 μ H / 820 nF
IIC (mixed circuit): Max. external inductivity L_o / Max. external capacitance C_o	2.2 mH / 47 nF, 2 mH / 49 nF, 1 mH / 63 nF, 500 μ H / 80 nF, 200 μ H / 107 nF
I (mixed circuit): Max. external inductivity L_o / Max. external capacitance C_o	37 mH / 0.54 μ F, 0.35 mH / 1 μ F, 0.009 mH / 2.9 μ F, 0.001 mH / 4.15 μ F

Interfaces

Data communication (bypass)

HART function	Yes
Protocols supported	HART-transparent

Signaling

Status display	Green LED (supply voltage)
----------------	----------------------------

Dimensions

Dimensional drawing	
Width	12.5 mm
Height	107.9 mm
Depth	113.7 mm
Depth NS 35/7,5	114.5 mm (Snapped onto DIN rail NS 35/7,5 in accordance with EN 60715)

Material specifications

MACX MCR-EX-SL-RPSS-2I-2I-SP - Repeater power supply



2924676

<https://www.phoenixcontact.com/us/products/2924676>

Flammability rating according to UL 94	V0 (Housing)
Housing material	PA 6.6-FR

Environmental and real-life conditions

Ambient conditions

Degree of protection	IP20 (not assessed by UL)
Ambient temperature (operation)	-40 °C ... 60 °C (Any mounting position)
	-40 °C ... 70 °C (Derating)
Ambient temperature (storage/transport)	-40 °C ... 80 °C
Permissible humidity (operation)	10 % ... 95 % (non-condensing)

Altitude range (≤ 2000 m)

Altitude	≤ 2000 m (The technical data refers to altitudes ≤2000 m above mean sea level. For altitudes >2000 m above mean sea level, refer to the data sheet.)
Ambient temperature (operation)	-40 °C ... 60 °C
	-40 °C ... 70 °C (Derating)
Rated insulation voltage	375 V _{PP} (Power supply, input / output)

Altitude range (≤ 3000 m)

Height range	> 2000 m ... 3000 m
Ambient temperature (operation)	-40 °C ... 54 °C
	-40 °C ... 63 °C (Derating)
Rated insulation voltage	190 V AC (Power supply, input / output)
	110 V DC (Power supply, input / output)

Altitude range (≤ 4000 m)

Height range	> 3000 m ... 4000 m
Ambient temperature (operation)	-40 °C ... 48 °C
	-40 °C ... 56 °C (Derating)
Rated insulation voltage	60 V AC/DC (Power supply, input / output)

Altitude range (≤ 5000 m)

Height range	> 4000 m ... 5000 m
Ambient temperature (operation)	-40 °C ... 42 °C
	-40 °C ... 49 °C (Derating)
Rated insulation voltage	60 V AC/DC (Power supply, input / output)

Approvals

CE

Certificate	CE-compliant
Note	and EN 61326

ATEX

Identification	⊕ II (1) G [Ex ia Ga] IIC
	⊕ II (1) D [Ex ia Da] IIIC

MACX MCR-EX-SL-RPSS-2I-2I-SP - Repeater power supply



2924676

<https://www.phoenixcontact.com/us/products/2924676>

	Ⓜ II 3(1) G Ex ec [ia Ga] IIC T4 Gc
	Ⓜ I (M1) [Ex ia Ma] I
Certificate	BVS 10 ATEX E 143 X

IECEX

Identification	[Ex ia Ga] IIC
	[Ex ia Da] IIIC
	Ex ec [ia Ga] IIC T4 Gc
	[Ex ia Ma] I
Certificate	IECEX BVS 10.0097X

CCC / China-Ex

Identification	[Ex ia Ga] IIC
	[Ex ia Da] IIIC
	Ex ec [ia Ga] IIC T4 Gc
Certificate	2022122316115972

UL, USA/Canada

Identification	IS for Class I, II, III Div 1
	Class I, Div. 2
Certificate	Ⓜ-Ⓜ C.D.-No 83104549

UL, USA/Canada

Identification	Class I Div 2; IS for Class I, II, III Div 1
Certificate	Ⓜ-Ⓜ C.D.-No 83104549

KC-s

Identification	[Ex ia] IIC/IIB
Certificate	17-KA4BO-0401X

Shipbuilding approval

Certificate	DNV GL TAA000020C
-------------	-------------------

Safety Integrity Level (SIL, IEC 61508)

Identification	3
----------------	---

Performance Level (ISO 13849)

Identification	d
----------------	---

INMETRO

Identification	[Ex ia Ga] IIC
	[Ex ia Da] IIIC
	Ex ec [ia Ga] IIC T4 Gc
Certificate	DNV 18.0140 X

DNV GL data

Temperature	B
Humidity	B

MACX MCR-EX-SL-RPSS-2I-2I-SP - Repeater power supply



2924676

<https://www.phoenixcontact.com/us/products/2924676>

Vibration	A
EMC	A
Enclosure	Required protection according to the Rules shall be provided upon installation on board

EMC data

Noise immunity	EN 61000-6-2
Note	When being exposed to interference, there may be minimal deviations.
Electromagnetic compatibility	Conformance with EMC directive
Noise emission	EN 61000-6-4

Standards and regulations

Electrical isolation	5-way isolation
----------------------	-----------------

GB Standard

Standards/regulations	GB/T 3836.1
	GB/T 3836.3
	GB/T 3836.4

Mounting

Mounting type	DIN rail mounting
---------------	-------------------

MACX MCR-EX-SL-RPSS-2I-2I-SP - Repeater power supply



2924676

<https://www.phoenixcontact.com/us/products/2924676>

Drawings

Diagram

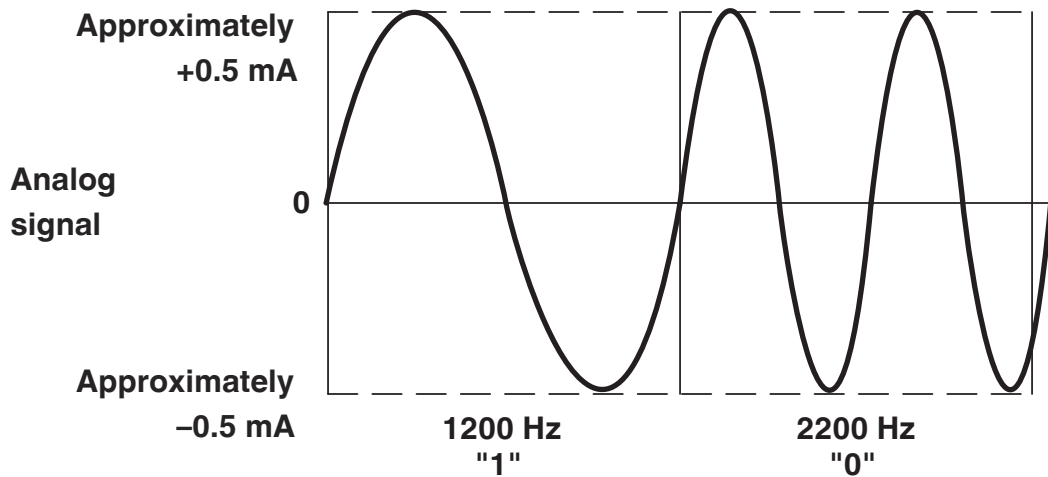

Signal transmission analog and digital at the same time

Block diagram

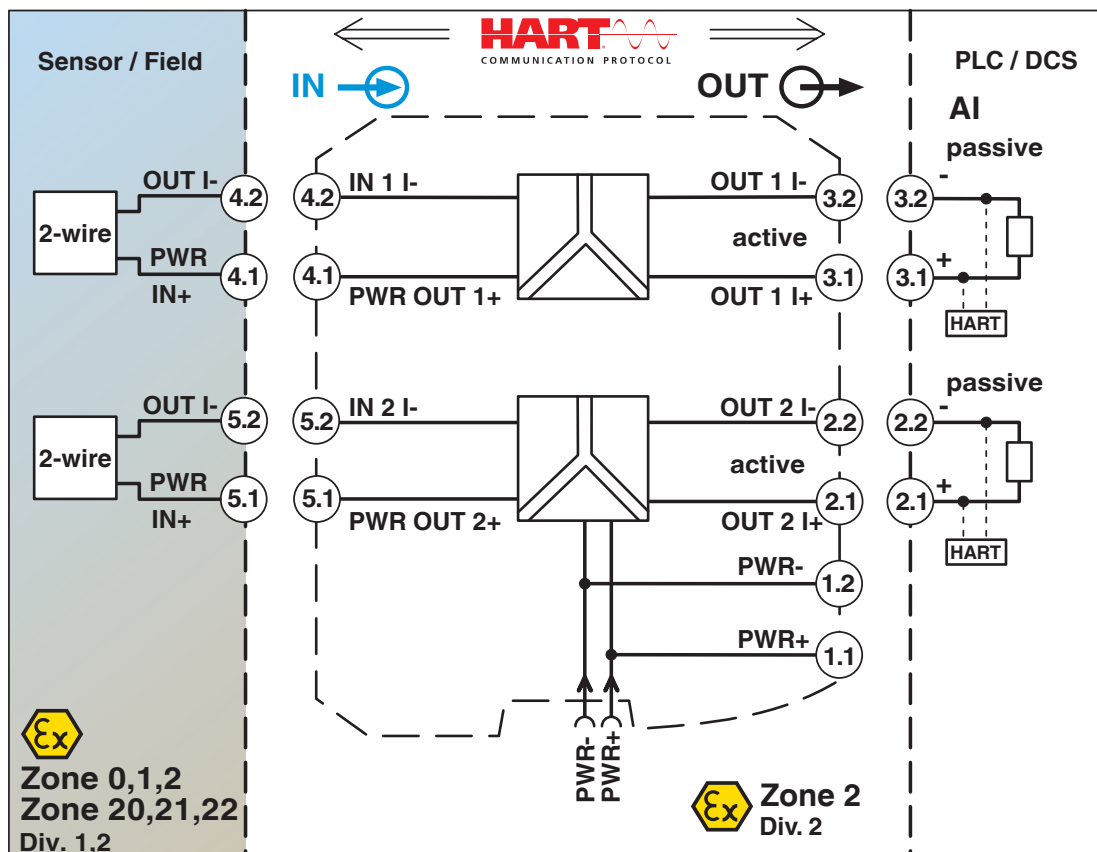

MACX MCR-EX-SL-RPSS-2I-2I-SP - Repeater power supply



2924676

<https://www.phoenixcontact.com/us/products/2924676>

Dimensional drawing

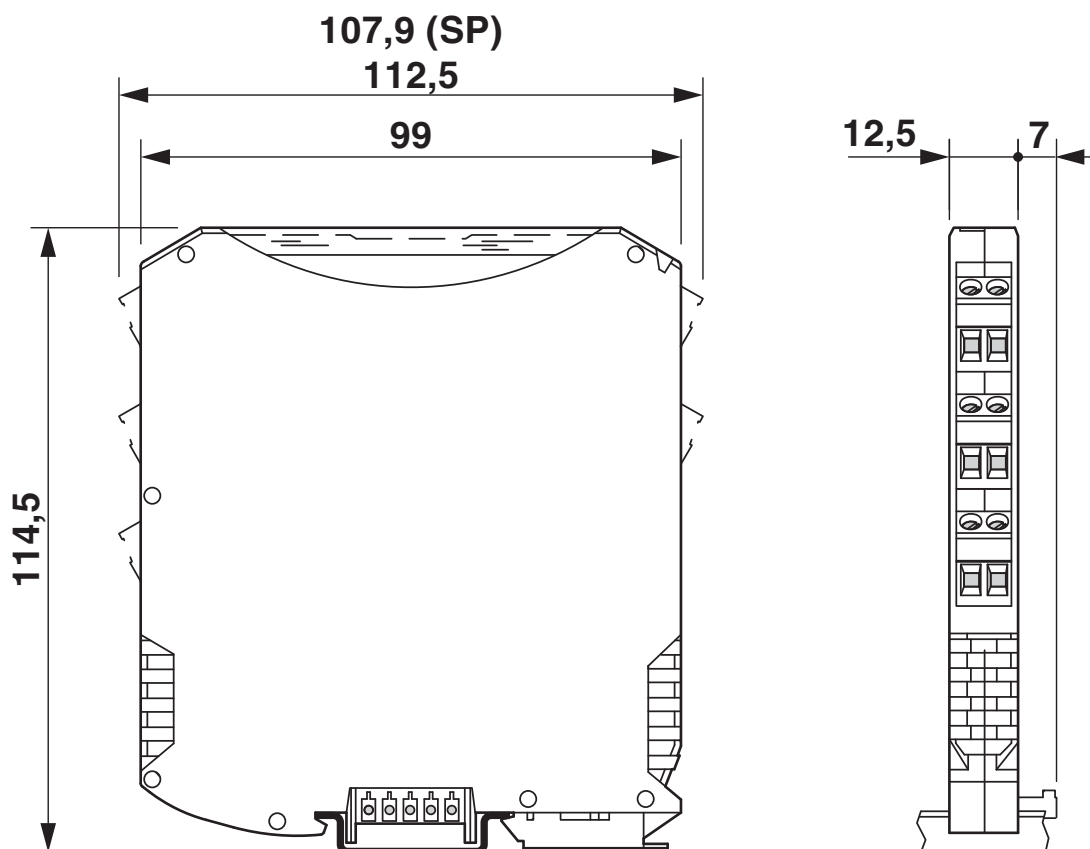

MACX MCR-EX-SL-RPSS-2I-2I-SP - Repeater power supply



2924676

<https://www.phoenixcontact.com/us/products/2924676>

Approvals

To download certificates, visit the product detail page: <https://www.phoenixcontact.com/us/products/2924676>



DNV GL

Approval ID: TAA000020C



UL Listed

Approval ID: FILE E 330267



CCC

Approval ID: 2020322 316001580

Functional Safety

Approval ID: BVS Pb 04/13



EAC Ex

Approval ID: RU C-DE.AB72.B.00093



IECEX

Approval ID: IECEX BVS 10.0097X



cUL Listed

Approval ID: FILE E 199827



UL Listed

Approval ID: FILE E 199827



ATEX

Approval ID: BVS 10 ATEX E143 X



KC-s

Approval ID: 17-KA4BO-0401X

INMETRO

Approval ID: DNV 18.0140 X

MACX MCR-EX-SL-RPSS-2I-2I-SP - Repeater power supply



2924676

<https://www.phoenixcontact.com/us/products/2924676>



ATEX

Approval ID: BVS 13 ATEX E 001 X



IECEx

Approval ID: IECEx BVS 13.0007X



CCC

Approval ID: 2022122316115972

cULus Listed

MACX MCR-EX-SL-RPSS-2I-2I-SP - Repeater power supply



2924676

<https://www.phoenixcontact.com/us/products/2924676>

Classifications

ECLASS

ECLASS-11.0	27210120
ECLASS-12.0	27210120
ECLASS-13.0	27210120

ETIM

ETIM 9.0	EC002653
----------	----------

UNSPSC

UNSPSC 21.0	39121000
-------------	----------

MACX MCR-EX-SL-RPSS-2I-2I-SP - Repeater power supply



2924676

<https://www.phoenixcontact.com/us/products/2924676>

Environmental product compliance

China RoHS	Environmentally Friendly Use Period = 50 years For information on hazardous substances, refer to the manufacturer's declaration available under "Downloads"
------------	--

MACX MCR-EX-SL-RPSS-2I-2I-SP - Repeater power supply



2924676

<https://www.phoenixcontact.com/us/products/2924676>

Accessories

ME 6,2 TBUS-2 1,5/5-ST-3,81 GY - DIN rail bus connectors

2695439

<https://www.phoenixcontact.com/us/products/2695439>

DIN rail connector (TBUS), 5-pos., for bridging the supply voltage, can be snapped onto NS 35/... DIN rail in accordance with EN 60715

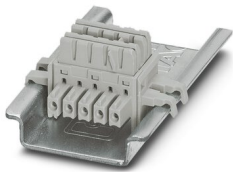

ME 6,2 TBUS-PR-ADAPTER - DIN rail bus connectors

1136500

<https://www.phoenixcontact.com/us/products/1136500>

Power rail adapter (ME 6,2 TBUS-PR-ADAPTER), 2-pos., enables MINI and MACX Analog modules to be adapted for supply via universal power rail UPR-03 and UPR-05.



MACX MCR-EX-SL-RPSS-2I-2I-SP - Repeater power supply



2924676

<https://www.phoenixcontact.com/us/products/2924676>

MCR-DP - Separating plate

1430594

<https://www.phoenixcontact.com/us/products/1430594>



The partition plate is used to maintain Ex i isolating distances when Ex i and non-Ex i devices are mounted side by side on a DIN rail.

GW HART USB MODEM - Cable adapter

1003824

<https://www.phoenixcontact.com/us/products/1003824>



USB HART modem cable for communication between a PC and HART devices, cable length: 1m.

MACX MCR-EX-SL-RPSS-2I-2I-SP - Repeater power supply



2924676

<https://www.phoenixcontact.com/us/products/2924676>

TC-2D37SUB-ADIO32-2EX-P-UNI - Module carrier

2904684

<https://www.phoenixcontact.com/us/products/2904684>



Universal Termination Carrier for connecting 16 two-channel MACX Analog Ex i signal conditioners to digital or analog I/O cards, via two D-SUB connectors, 37-pos. (1:1 connection)

MPS-IH WH - Insulating sleeve

0201663

<https://www.phoenixcontact.com/us/products/0201663>

Insulating sleeve, color: white



MACX MCR-EX-SL-RPSS-2I-2I-SP - Repeater power supply



2924676

<https://www.phoenixcontact.com/us/products/2924676>

MPS-IH RD - Insulating sleeve

0201676

<https://www.phoenixcontact.com/us/products/0201676>

Insulating sleeve, color: red



MPS-IH BU - Insulating sleeve

0201689

<https://www.phoenixcontact.com/us/products/0201689>

Insulating sleeve, color: blue

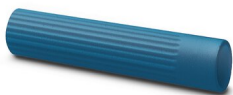

MACX MCR-EX-SL-RPSS-2I-2I-SP - Repeater power supply



2924676

<https://www.phoenixcontact.com/us/products/2924676>

MPS-IH YE - Insulating sleeve

0201692

<https://www.phoenixcontact.com/us/products/0201692>

Insulating sleeve, color: yellow



MPS-IH GN - Insulating sleeve

0201702

<https://www.phoenixcontact.com/us/products/0201702>

Insulating sleeve, color: green



MACX MCR-EX-SL-RPSS-2I-2I-SP - Repeater power supply



2924676

<https://www.phoenixcontact.com/us/products/2924676>

MPS-IH GY - Insulating sleeve

0201728

<https://www.phoenixcontact.com/us/products/0201728>

Insulating sleeve, color: gray



MPS-IH BK - Insulating sleeve

0201731

<https://www.phoenixcontact.com/us/products/0201731>

Insulating sleeve, color: black



MACX MCR-EX-SL-RPSS-2I-2I-SP - Repeater power supply



2924676

<https://www.phoenixcontact.com/us/products/2924676>

MPS-MT - Test plug

0201744

<https://www.phoenixcontact.com/us/products/0201744>



Test plug, with solder connection up to 1 mm² conductor cross section, number of positions: 1, color: gray

UC-EMLP (11X9) - Plastic label

0819291

<https://www.phoenixcontact.com/us/products/0819291>



Plastic label, Sheet, white, unlabeled, can be labeled with: BLUEMARK ID COLOR, BLUEMARK ID, BLUEMARK CLED, PLOTMARK, CMS-P1-PLOTTER, mounting type: adhesive, lettering field size: 11 x 9 mm, Number of individual labels: 10

MACX MCR-EX-SL-RPSS-2I-2I-SP - Repeater power supply



2924676

<https://www.phoenixcontact.com/us/products/2924676>

UC-EMLP (11X9) YE - Plastic label

0822602

<https://www.phoenixcontact.com/us/products/0822602>

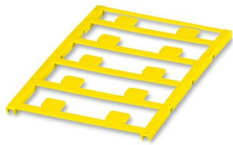

Plastic label, Sheet, yellow, unlabeled, can be labeled with: BLUEMARK ID COLOR, BLUEMARK ID, BLUEMARK CLED, PLOTMARK, CMS-P1-PLOTTER, mounting type: adhesive, lettering field size: 11 x 9 mm, Number of individual labels: 10

UC-EMLP (11X9) CUS - Plastic label

0824547

<https://www.phoenixcontact.com/us/products/0824547>



Plastic label, can be ordered: by sheet, white, labeled according to customer specifications, mounting type: adhesive, lettering field size: 11 x 9 mm

MACX MCR-EX-SL-RPSS-2I-2I-SP - Repeater power supply



2924676

<https://www.phoenixcontact.com/us/products/2924676>

UC-EMLP (11X9) YE CUS - Plastic label

0824548

<https://www.phoenixcontact.com/us/products/0824548>

Plastic label, can be ordered: by sheet, yellow, labeled according to customer specifications, mounting type: adhesive, lettering field size: 11 x 9 mm

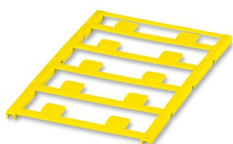

UC-EMLP (11X9) SR - Plastic label

0828094

<https://www.phoenixcontact.com/us/products/0828094>

Plastic label, Sheet, silver, unlabeled, can be labeled with: BLUEMARK ID COLOR, BLUEMARK ID, BLUEMARK CLED, PLOTMARK, CMS-P1-PLOTTER, mounting type: adhesive, lettering field size: 11 x 9 mm, Number of individual labels: 10



MACX MCR-EX-SL-RPSS-2I-2I-SP - Repeater power supply



2924676

<https://www.phoenixcontact.com/us/products/2924676>

UC-EMLP (11X9) SR CUS - Plastic label

0828098

<https://www.phoenixcontact.com/us/products/0828098>



Plastic label, can be ordered: by sheet, silver, labeled according to customer specifications, mounting type: adhesive, lettering field size: 11 x 9 mm, Number of individual labels: 10

US-EMLP (11X9) - Plastic label

0828789

<https://www.phoenixcontact.com/us/products/0828789>



Plastic label, Card, white, unlabeled, can be labeled with: BLUEMARK ID COLOR, BLUEMARK ID, THERMOMARK PRIME, THERMOMARK CARD 2.0, THERMOMARK CARD, mounting type: adhesive, lettering field size: 11 x 9 mm, Number of individual labels: 135

MACX MCR-EX-SL-RPSS-2I-2I-SP - Repeater power supply



2924676

<https://www.phoenixcontact.com/us/products/2924676>

US-EMLP (11X9) YE - Plastic label

0828871

<https://www.phoenixcontact.com/us/products/0828871>



Plastic label, Card, yellow, unlabeled, can be labeled with: BLUEMARK ID COLOR, BLUEMARK ID, THERMOMARK PRIME, THERMOMARK CARD 2.0, THERMOMARK CARD, mounting type: adhesive, lettering field size: 11 x 9 mm, Number of individual labels: 135

US-EMLP (11X9) SR - Plastic label

0828872

<https://www.phoenixcontact.com/us/products/0828872>



Plastic label, Card, silver, unlabeled, can be labeled with: BLUEMARK ID COLOR, BLUEMARK ID, THERMOMARK PRIME, THERMOMARK CARD 2.0, THERMOMARK CARD, mounting type: adhesive, lettering field size: 11 x 9 mm, Number of individual labels: 135

MACX MCR-EX-SL-RPSS-2I-2I-SP - Repeater power supply



2924676

<https://www.phoenixcontact.com/us/products/2924676>

LS-EMLP (11X9) WH - Device marker

0831678

<https://www.phoenixcontact.com/us/products/0831678>

Device marker, Sheet, white, unlabeled, can be labeled with: TOPMARK NEO, TOPMARK LASER, mounting type: adhesive, lettering field size: 11 x 9 mm, Number of individual labels: 255



LS-EMLP (11X9) SR - Device marker

0831705

<https://www.phoenixcontact.com/us/products/0831705>

Device marker, Sheet, silver, unlabeled, can be labeled with: TOPMARK NEO, TOPMARK LASER, mounting type: adhesive, lettering field size: 11 x 9 mm, Number of individual labels: 255



MACX MCR-EX-SL-RPSS-2I-2I-SP - Repeater power supply



2924676

<https://www.phoenixcontact.com/us/products/2924676>

LS-EMLP (11X9) YE - Device marker

0831732

<https://www.phoenixcontact.com/us/products/0831732>

Device marker, Sheet, yellow, unlabeled, can be labeled with: TOPMARK NEO, TOPMARK LASER, mounting type: adhesive, lettering field size: 11 x 9 mm, Number of individual labels: 255



MACX MCR-PTB - Power and error message module

2865625

<https://www.phoenixcontact.com/us/products/2865625>

Power and fault signaling module with screw connection, including corresponding ME 17,5 TBUS 1,5/ 5-ST-3,81 GY DIN rail connector



MACX MCR-EX-SL-RPSS-2I-2I-SP - Repeater power supply



2924676

<https://www.phoenixcontact.com/us/products/2924676>

MACX MCR-PTB-SP - Power and error message module

2924184

<https://www.phoenixcontact.com/us/products/2924184>



Power and fault signaling module with Push-in connection, including corresponding ME 17,5 TBUS 1,5/ 5-ST-3,81 GY DIN rail connector

QUINT4-SYS-PS/1AC/24DC/2.5/SC - Power supply unit

2904614

<https://www.phoenixcontact.com/us/products/2904614>



Primary-switched power supply, QUINT POWER, screw connection, DIN rail mounting, supply of devices possible via the TBUS DIN rail connector, protective coating, input: single-phase, output: 24 V DC/2.5 A

MACX MCR-EX-SL-RPSS-2I-2I-SP - Repeater power supply



2924676

<https://www.phoenixcontact.com/us/products/2924676>

SZS 0,6X3,5 - Screwdriver

1205053

<https://www.phoenixcontact.com/us/products/1205053>



Actuation tool, for ST terminal blocks, insulated, also suitable for use as a bladed screwdriver, size: 0.6 x 3.5 x 100 mm, 2-component grip, with non-slip grip

MACX EX-SET-TVFKC 2-POLE - Connector set

1584378

<https://www.phoenixcontact.com/us/products/1584378>

TVFKC plug set for MACX Ex i devices with 2-pos. plugs

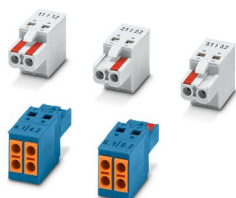

Phoenix Contact 2023 © - all rights reserved
<https://www.phoenixcontact.com>

Phoenix Contact USA
586 Fulling Mill Road
Middletown, PA 17057, United States
(+717) 944-1300
info@phoenixcon.com