

QUINT4-SYS-PS/1AC/24DC/2.5/SC - Power supply unit



2904614

<https://www.phoenixcontact.com/us/products/2904614>

Please be informed that the data shown in this PDF document is generated from our online catalog. Please find the complete data in the user documentation. Our general terms of use for downloads are valid.



Primary-switched power supply, QUINT POWER, screw connection, DIN rail mounting, supply of devices possible via the TBUS DIN rail connector, protective coating, input: single-phase, output: 24 V DC/2.5 A

Your advantages

- Also for operation in potentially explosive areas (zone 2)
- Optionally for supplying devices via the TBUS DIN rail connector
- Preventive function monitoring indicates critical operating states before errors occur
- Starting of heavy loads with dynamic boost
- High efficiency and long service life, with low power dissipation and low heating

Commercial data

Item number	2904614
Packing unit	1 pc
Minimum order quantity	1 pc
Sales key	CM10
Product key	CMPI13
GTIN	4055626255651
Weight per piece (including packing)	360 g
Weight per piece (excluding packing)	360 g
Customs tariff number	85044095
Country of origin	VN

QUINT4-SYS-PS/1AC/24DC/2.5/SC - Power supply unit



2904614

<https://www.phoenixcontact.com/us/products/2904614>

Technical data

Input data

AC operation

Nominal input voltage range	100 V AC ... 240 V AC
Input voltage range	100 V AC ... 240 V AC -15 % ... +10 %
Electric strength, max.	300 V AC 30 s
Typical national grid voltage	120 V AC 230 V AC
Voltage type of supply voltage	AC/DC
Inrush current	typ. 10 A (at 25 °C)
Inrush current integral (I^2t)	typ. 0.1 A ² s
Inrush current limitation	10 A
Frequency range (f_N)	50 Hz ... 60 Hz \pm 10 % 16.7 Hz (acc. to EN 50163)
Mains buffering time	typ. 31 ms (120 V AC) typ. 31 ms (230 V AC)
Current consumption	0.85 A (100 V AC) 0.7 A (120 V AC) 0.39 A (230 V AC) 0.37 A (240 V AC)
Protective circuit	Transient surge protection; Varistor
Typical response time	500 ms
Input fuse	4 A (slow-blow, internal)
Recommended breaker for input protection	6 A ... 16 A (Characteristic B, C, D, K or comparable)
Discharge current to PE	< 0.25 mA (264 V AC, 60 Hz) < 0.22 mA

DC operation

Input voltage range	110 V DC ... 250 V DC -20 % ... +40 %
Voltage type of supply voltage	AC/DC
Current consumption	0.75 A (110 V DC) 0.33 A (250 V DC)

Output data

Efficiency	typ. 93 % (120 V AC) typ. 94 % (230 V AC)
Nominal output voltage	24 V DC
Setting range of the output voltage (U_{Set})	24 V DC ... 27 V DC (constant capacity)
Nominal output current (I_N)	2.5 A
Static Boost ($I_{Stat.Boost}$)	3.125 A (\leq 40 °C)
Dynamic Boost ($I_{Dyn.Boost}$)	4 A (\leq 60 °C (on \leq 5 s/off \geq 5 s))
Feedback voltage resistance	\leq 32 V DC

QUINT4-SYS-PS/1AC/24DC/2.5/SC - Power supply unit



2904614

<https://www.phoenixcontact.com/us/products/2904614>

Protection against overvoltage at the output (OVP)	$\leq 30 \text{ V DC } \pm 2 \%$
Control deviation	$< 0.5 \%$ (Static load change 10 % ... 90 %)
	$< 2 \%$ (Dynamic load change 10 % ... 90 %, (10 Hz))
	$< 0.25 \%$ (change in input voltage $\pm 10 \%$)
Residual ripple	$< 40 \text{ mV}_{PP}$ (with nominal values)
Short-circuit-proof	yes
No-load proof	yes
Output power	60 W
	75 W
	96 W
Maximum no-load power dissipation	$< 1 \text{ W}$ (120 V AC)
	$< 1 \text{ W}$ (230 V AC)
Power loss nominal load max.	$< 5 \text{ W}$ (120 V AC)
	$< 4 \text{ W}$ (230 V AC)
Crest factor	typ. 1.8 (120 V AC)
	typ. 1.84 (230 V AC)
Rise time	50 ms ($U_{Out} = 10 \%$... 90 %)
Signal (configurable)	
Digital	0 V DC 24 V DC 30 mA
Default	24 V DC 30 mA 24 V DC for $U_{Out} > 0.9 \times U_{Set}$

Connection data

Input

Connection method	Screw connection
Conductor cross section, rigid min.	0.14 mm ²
Conductor cross section, rigid max.	2.5 mm ²
Conductor cross section flexible min.	0.14 mm ²
Conductor cross section flexible max.	2.5 mm ²
Single conductor/terminal point, stranded, with ferrule, min.	0.25 mm ²
Single conductor/terminal point, stranded, with ferrule, max.	2.5 mm ²
Conductor cross section AWG min.	26
Conductor cross section AWG max.	14
Stripping length	8 mm
Tightening torque, min	0.5 Nm
Tightening torque max	0.6 Nm

Output

Connection method	Screw connection
Conductor cross section, rigid min.	0.14 mm ²
Conductor cross section, rigid max.	2.5 mm ²
Conductor cross section flexible min.	0.14 mm ²
Conductor cross section flexible max.	2.5 mm ²
Single conductor/terminal point, stranded, with ferrule, min.	0.25 mm ²

QUINT4-SYS-PS/1AC/24DC/2.5/SC - Power supply unit



2904614

<https://www.phoenixcontact.com/us/products/2904614>

Single conductor/terminal point, stranded, with ferrule, max.	2.5 mm ²
Conductor cross section AWG min.	26
Conductor cross section AWG max.	14
Stripping length	8 mm
Tightening torque, min	0.5 Nm
Tightening torque max	0.6 Nm

Signal

Connection method	Screw connection
Conductor cross section, rigid min.	0.14 mm ²
Conductor cross section, rigid max.	2.5 mm ²
Conductor cross section flexible min.	0.14 mm ²
Conductor cross section flexible max.	2.5 mm ²
Single conductor/terminal point, stranded, with ferrule, min.	0.25 mm ²
Single conductor/terminal point, stranded, with ferrule, max.	2.5 mm ²
Conductor cross section AWG min.	26
Conductor cross section AWG max.	14
Stripping length	8 mm
Tightening torque, min	0.5 Nm
Tightening torque max	0.6 Nm

Signaling

Types of signaling	LED
--------------------	-----

Signal output

P_{Out}	> P_{Thr} (LED lights up yellow, output power > P_{Thr} , depending on the rotary selector switch setting)
U_{Out}	> $0.9 \times U_{Set}$ (LED lights up green)
	< $0.9 \times U_{Set}$ (LED flashes green)

Electrical properties

Number of phases	1.00
Insulation voltage input/output	4 kV AC (type test)
	3 kV AC (routine test)
Switching frequency	90 kHz ... 110 kHz (Auxiliary converter stage)
	50 kHz ... 195 kHz (Main converter stage)
	60 kHz ... 360 kHz (PFC stage)

Product properties

Product type	Power supply
Product family	QUINT POWER
MTBF (IEC 61709, SN 29500)	> 2000000 h (25 °C)
	> 1161000 h (40 °C)
	> 514000 h (60 °C)
RoHS Directive 2011/65/EU	

QUINT4-SYS-PS/1AC/24DC/2.5/SC - Power supply unit



2904614

<https://www.phoenixcontact.com/us/products/2904614>

Environmental protection directive	WEEE
	Reach

Insulation characteristics

Protection class	II
Degree of pollution	2

Life expectancy (electrolytic capacitors)

Current	2.5 A
Temperature	40 °C
Time	323000 h
Additional text	120 V AC

Life expectancy (electrolytic capacitors)

Current	2.5 A
Temperature	40 °C
Time	346000 h
Additional text	230 V AC

Life expectancy (electrolytic capacitors)

Current	2.5 A
Temperature	25 °C
Time	915000 h
Additional text	120 V AC

Life expectancy (electrolytic capacitors)

Current	2.5 A
Temperature	25 °C
Time	980000 h
Additional text	230 V AC

Dimensions

Width	40 mm
Height	99 mm
Depth	114 mm

Installation dimensions

Installation distance right/left (active)	15 mm / 15 mm ($P_{Out} \geq 50\%$)
Installation distance right/left (passive)	5 mm / 5 mm ($P_{Out} \geq 50\%$)
Installation distance right/left (active, passive)	0 mm / 0 mm ($P_{Out} \leq 50\%$)
Installation distance top/bottom (active)	30 mm / 30 mm ($P_{Out} \geq 50\%$)
Installation distance top/bottom (passive)	30 mm / 30 mm ($P_{Out} \geq 50\%$)
Installation distance top/bottom (active, passive)	30 mm / 30 mm ($P_{Out} \leq 50\%$)

Mounting

Mounting type	DIN rail mounting
With protective coating	No

QUINT4-SYS-PS/1AC/24DC/2.5/SC - Power supply unit



2904614

<https://www.phoenixcontact.com/us/products/2904614>

Material specifications

Flammability rating according to UL 94 (housing / terminal blocks)	V0
Housing material	Plastic
Type of housing	Polycarbonate
Hood version	Polycarbonate

Environmental and real-life conditions

Ambient conditions

Degree of protection	IP20
Ambient temperature (operation)	-25 °C ... 70 °C (> 60 °C Derating: 2,5 %/K)
Ambient temperature (storage/transport)	-40 °C ... 85 °C
Ambient temperature (start-up type tested)	-40 °C
Maximum altitude	≤ 5000 m (> 2000 m, observe derating)
Climatic class	3K3 (in acc. with EN 60721)
Max. permissible relative humidity (operation)	≤ 95 % (at 25 °C, non-condensing)
Shock	18 ms, 30g, in each space direction (according to IEC 60068-2-27)
Vibration (operation)	5 Hz ... 100 Hz resonance search 2.3g, 90 min., resonance frequency 2.3g, 90 min. (according to DNV GL Class C)

Standards and regulations

Rail applications	EN 50121-3-2
	EN 50121-4
	EN 50121-5
	IEC 62236-3-2
	IEC 62236-4
	IEC 62236-5
Standard – Limitation of mains harmonic currents	EN 61000-3-2
Standard – Safety extra-low voltage	IEC 61010-1 (SELV)
	IEC 61010-2-201 (PELV)
Standard - Safe isolation	IEC 61558-2-16
	IEC 61010-2-201
Standard - safety for equipment for measurement, control, and laboratory use	IEC 61010-1
	IEC 61010-2-201 (SELV)
Standard - Safety of transformers	EN 61558-2-16

Overvoltage category

EN 61010-1	II (≤ 5000 m)
EN 62477-1	III (≤ 2000 m)

Approvals

ATEX

Identification	UL 21 ATEX 2597 X
----------------	-------------------

QUINT4-SYS-PS/1AC/24DC/2.5/SC - Power supply unit



2904614

<https://www.phoenixcontact.com/us/products/2904614>

	Ⓜ II 3 G Ex ec nC IIC T4 Gc
IECEX	
Identification	IECEX ULD 21.0023X
	Ex ec nC IIC T4 Gc
UKEX	
Identification	UL21UKEX2208X
UL	
Identification	UL Listed UL 61010-1
UL	
Identification	UL Listed UL 61010-2-201
UL	
Identification	UL 1310 Class 2 Power Units
UL	
Identification	ANSI/UL 121201 Class I, Division 2, Groups A, B, C, D (Hazardous Location)
SIQ	
Identification	CB scheme (IEC 61010-1, IEC 61010-2-201)

EMC data

Interference emission	Interference emission in accordance with EN 61000-6-3 (residential and commercial) and EN 61000-6-4 (industrial)
Noise immunity	Immunity in accordance with EN 61000-6-1 (residential), EN 61000-6-2 (industrial), and EN 61000-6-5 (power station equipment zone), IEC/EN 61850-3 (power supply)
Electromagnetic compatibility	Conformance with EMC Directive 2014/30/EU
EMC requirements, power plant	IEC 61850-3
	EN 61000-6-5
Conducted noise emission	EN 55016
	EN 61000-6-3 (Class B)
Noise emission	Additional basic standard EN 61000-6-5 (immunity in power station), IEC/EN 61850-3 (energy supply)
Noise emission	EN 55016
	EN 61000-6-3 (Class B)
Harmonic currents	
Standards/regulations	EN 61000-3-2
	EN 61000-3-2 (Class A)
Frequency range	0 kHz ... 2 kHz
Flicker	
Standards/regulations	EN 61000-3-3
Frequency range	0 kHz ... 2 kHz

QUINT4-SYS-PS/1AC/24DC/2.5/SC - Power supply unit



2904614

<https://www.phoenixcontact.com/us/products/2904614>

Electrostatic discharge

Standards/regulations	EN 61000-4-2
-----------------------	--------------

Electrostatic discharge

Contact discharge	8 kV (Test Level 4)
Discharge in air	15 kV (Test Level 4)
Comments	Criterion A

Electromagnetic HF field

Standards/regulations	EN 61000-4-3
-----------------------	--------------

Electromagnetic HF field

Frequency range	80 MHz ... 1 GHz
Test field strength	20 V/m (Test Level X)
Frequency range	1 GHz ... 6 GHz
Test field strength	10 V/m (Test Level 3)
Comments	Criterion A

Fast transients (burst)

Standards/regulations	EN 61000-4-4
-----------------------	--------------

Fast transients (burst)

Input	4 kV (Test Level 4 - asymmetrical)
Output	4 kV (Test Level X - asymmetrical)
Signal	4 kV (Test Level X - asymmetrical)
Comments	Criterion A

Surge voltage load (surge)

Standards/regulations	EN 61000-4-5
Input	2 kV (Test Level 4 - symmetrical) 4 kV (Test Level 4 - asymmetrical)
Output	1 kV (Test Level 3 - symmetrical) 2 kV (Test Level 3 - asymmetrical)
Comments	Criterion A

Conducted interference

Standards/regulations	EN 61000-4-6
-----------------------	--------------

Conducted interference

I/O/S	asymmetrical
Frequency range	0.15 MHz ... 80 MHz
Comments	Criterion A
Voltage	10 V (Test Level 3)

Power frequency magnetic field

Standards/regulations	EN 61000-4-8 16.67 Hz
-----------------------	--------------------------

QUINT4-SYS-PS/1AC/24DC/2.5/SC - Power supply unit



2904614

<https://www.phoenixcontact.com/us/products/2904614>

Frequency	50 Hz
	60 Hz
Test field strength	100 A/m
Additional text	60 s
Comments	Criterion A
Frequency	50 Hz
	60 Hz
Frequency range	50 Hz ... 60 Hz
Test field strength	1 kA/m
Additional text	3 s
Frequency	0 Hz
Test field strength	300 A/m
Additional text	DC, 60 s

Voltage dips

Standards/regulations	EN 61000-4-11
Voltage	100 V AC
Frequency	60 Hz
Voltage dip	70 %
Number of periods	0.5 / 1 / 30 periods
Additional text	Test Level 2
Comments	Criterion A
Voltage dip	40 %
Number of periods	5 / 10 / 50 periods
Additional text	Test Level 2
Comments	Criterion B
Voltage dip	0 %
Number of periods	0.5 / 1 / 5 / 50 periods
Additional text	Test Level 2
Comments	Criterion B

Pulse-shape magnetic field

Standards/regulations	EN 61000-4-9
Test field strength	1000 A/m
Comments	Criterion A

Attenuated sinusoidal oscillations (ring wave)

Standards/regulations	EN 61000-4-12
Input	2 kV (symmetrical)
	4 kV (asymmetrical)
Comments	Criterion A

Asymmetrical conducted disturbance variables

Standards/regulations	EN 61000-4-16
Test level 1	16.67 Hz 50 Hz 60 Hz 150 Hz 180 Hz (Test Level 3)
Voltage	30 V (10 s)

QUINT4-SYS-PS/1AC/24DC/2.5/SC - Power supply unit



2904614

<https://www.phoenixcontact.com/us/products/2904614>

Test level 2	16.67 Hz 50 Hz 60 Hz (Test Level 2)
Voltage	300 V (1 s)
Comments	Criterion A

Attenuated oscillating wave

Standards/regulations	EN 61000-4-18
Voltage	1 kV (symmetrical)
	2.5 kV (asymmetrical)
	1 kV (symmetrical)
Comments	Criterion A

Criteria

Criterion A	Normal operating behavior within the specified limits.
Criterion B	Temporary impairment to operational behavior that is corrected by the device itself.
Criterion C	Temporary adverse effects on the operating behavior, which the device corrects automatically or which can be restored by actuating the operating elements.

QUINT4-SYS-PS/1AC/24DC/2.5/SC - Power supply unit



2904614

<https://www.phoenixcontact.com/us/products/2904614>

Drawings

Diagram

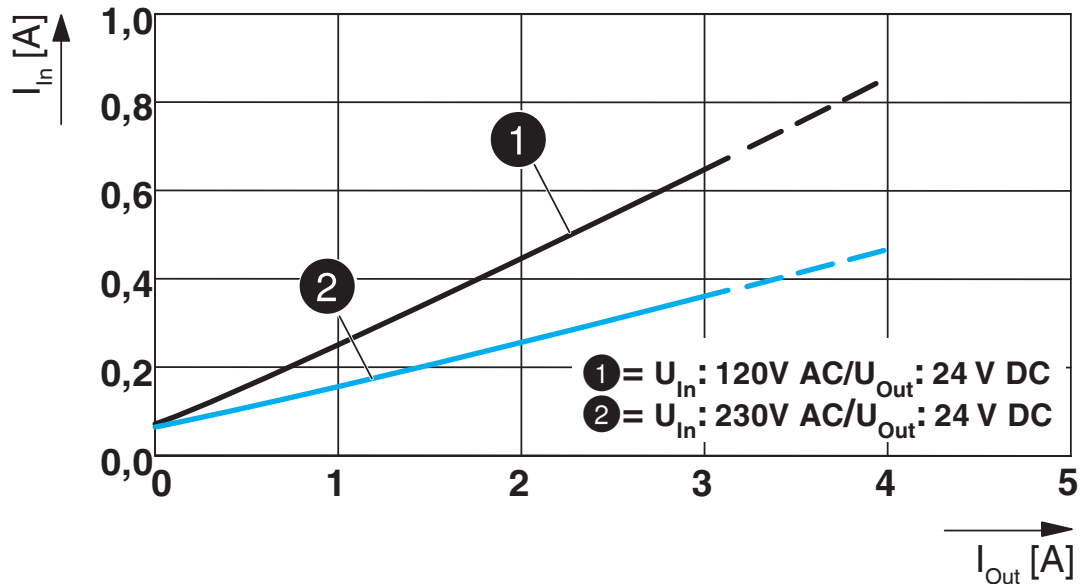

Diagram

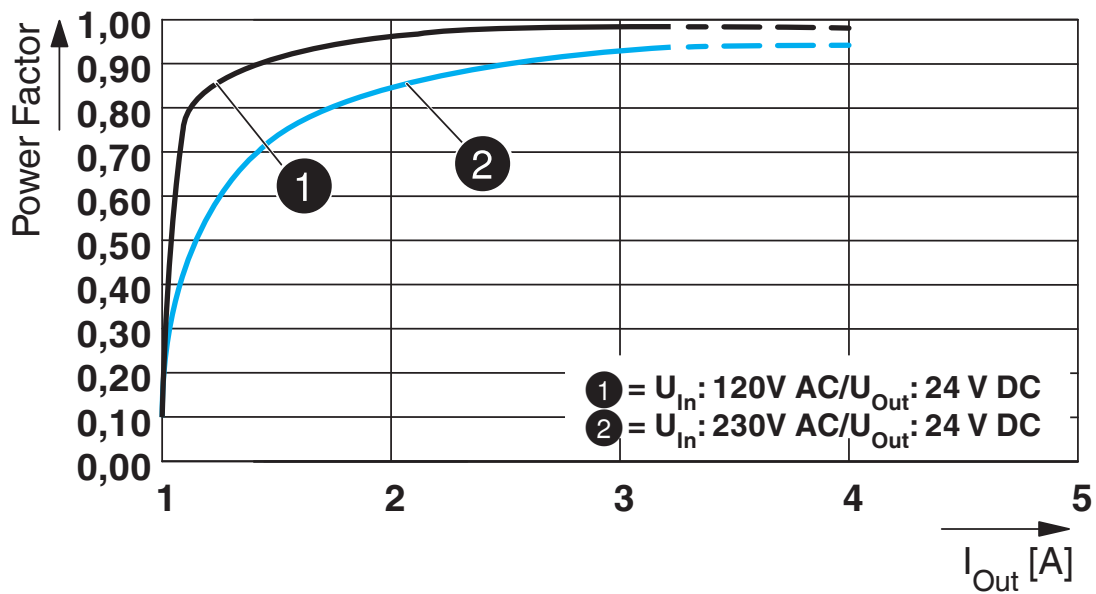

QUINT4-SYS-PS/1AC/24DC/2.5/SC - Power supply unit



2904614

<https://www.phoenixcontact.com/us/products/2904614>

Block diagram

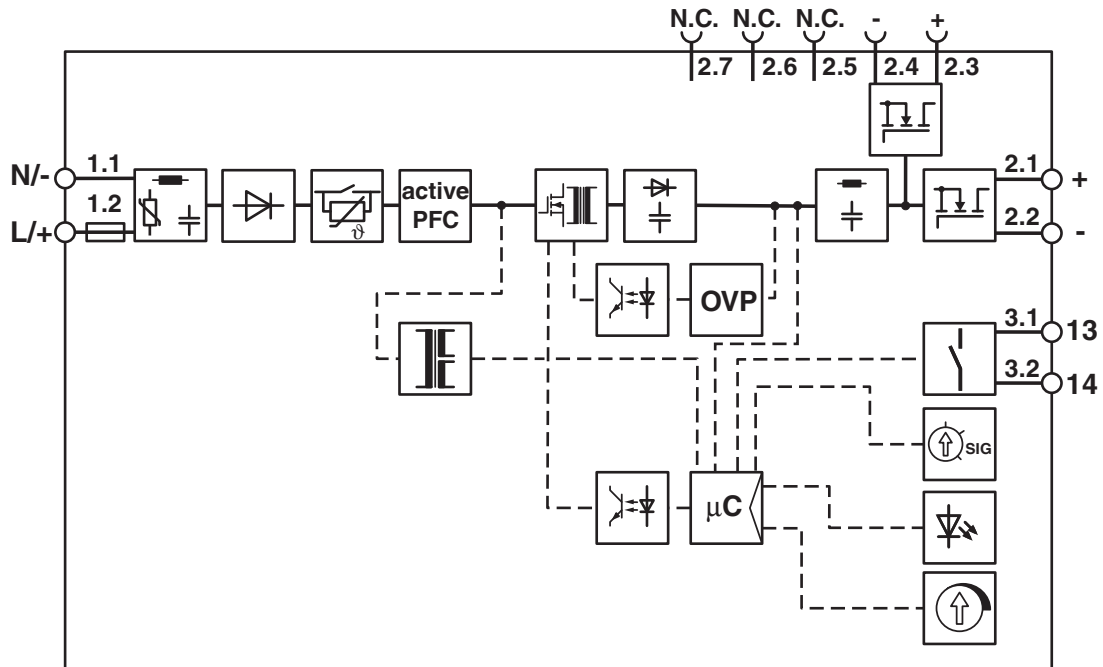

2904614

<https://www.phoenixcontact.com/us/products/2904614>

Schematic diagram

Housing

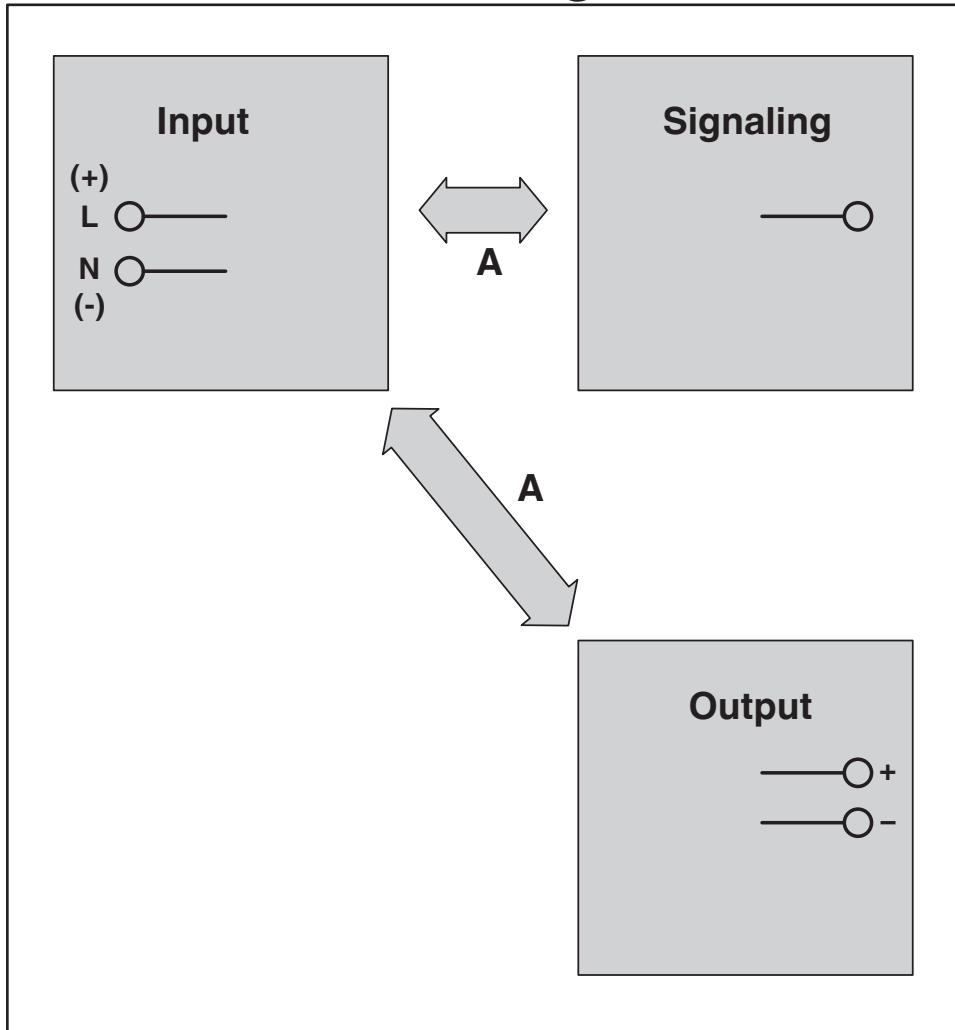

QUINT4-SYS-PS/1AC/24DC/2.5/SC - Power supply unit



2904614

<https://www.phoenixcontact.com/us/products/2904614>

Diagram

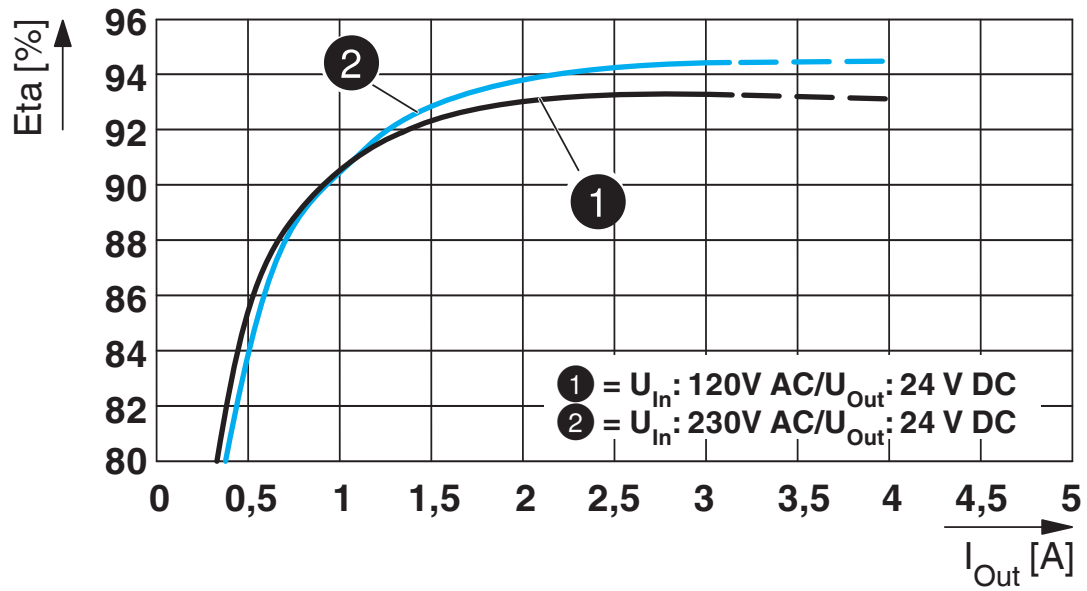

QUINT4-SYS-PS/1AC/24DC/2.5/SC - Power supply unit



2904614

<https://www.phoenixcontact.com/us/products/2904614>

Approvals

To download certificates, visit the product detail page: <https://www.phoenixcontact.com/us/products/2904614>



IECEE CB Scheme

Approval ID: DK-116799-A1-UL



cULus Listed

Approval ID: FILE E 123528

DNV

Approval ID: TAA00000BV



Type approved

Approval ID: SI-SIQ BG 005/109



LR

Approval ID: LR22472797TA



IECEX

Approval ID: IECEX ULD 21.0023X



ATEX

Approval ID: UL 21 ATEX 2597X



cULus Listed

Approval ID: FILE E 199827



UKCA-EX

Approval ID: UL21UKEX2208X

QUINT4-SYS-PS/1AC/24DC/2.5/SC - Power supply unit



2904614

<https://www.phoenixcontact.com/us/products/2904614>

Classifications

ECLASS

ECLASS-11.0	27040701
ECLASS-12.0	27040701
ECLASS-13.0	27040701

ETIM

ETIM 9.0	EC002540
----------	----------

UNSPSC

UNSPSC 21.0	39121000
-------------	----------

QUINT4-SYS-PS/1AC/24DC/2.5/SC - Power supply unit



2904614

<https://www.phoenixcontact.com/us/products/2904614>

Environmental product compliance

China RoHS	Environmentally Friendly Use Period = 25; For information on hazardous substances, refer to the manufacturer's declaration available under "Downloads"
------------	---

QUINT4-SYS-PS/1AC/24DC/2.5/SC - Power supply unit



2904614

<https://www.phoenixcontact.com/us/products/2904614>

Accessories

SF-SL 0,4X2,0-60 - Screwdriver

1212546

<https://www.phoenixcontact.com/us/products/1212546>



Screwdriver, flat bladed, size: 0.4 x 2.0 x 60 mm, 2-component grip, with non-slip grip

PLT-SEC-T3-230-FM-UT - Type 3 surge protection device

2907919

<https://www.phoenixcontact.com/us/products/2907919>



Type 2/3 surge protection, consisting of protective plug and base element with screw connection. For single-phase power supply network with integrated status indicator and remote signaling. Nominal voltage: 230 V AC/DC

QUINT4-SYS-PS/1AC/24DC/2.5/SC - Power supply unit



2904614

<https://www.phoenixcontact.com/us/products/2904614>

PLT-SEC-T3-24-FM-UT - Type 3 surge protection device

2907916

<https://www.phoenixcontact.com/us/products/2907916>



Type 3 surge protection, consisting of protective plug and base element, with integrated status indicator and remote signaling for single-phase power supply networks. Nominal voltage: 24 V AC/DC

ME 22,5 TBUS ADAPTER KMGY - DIN rail bus connectors

2201756

<https://www.phoenixcontact.com/us/products/2201756>

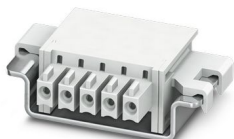

DIN rail bus adapter for ME and ME-MAX, design width: 22.5 mm, 5 parallel positions, color: light gray (similar to RAL 7035)

QUINT4-SYS-PS/1AC/24DC/2.5/SC - Power supply unit



2904614

<https://www.phoenixcontact.com/us/products/2904614>

ME 17,5 TBUS 1,5/ 5-ST-3,81 KMGY - DIN rail bus connectors

2713645

<https://www.phoenixcontact.com/us/products/2713645>

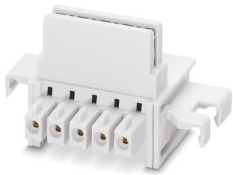

DIN rail connector, color: light grey, nominal current: 8 A (parallel contacts), rated voltage (III/2): 125 V, number of positions: 5, pitch: 3.81 mm, mounting: DIN rail mounting, locking: without, mounting: without, type of packaging: packed in cardboard, Item with gold-plated contacts, bus connectors for connecting with electronics housings, 5 parallel contacts

PTCB E1 24DC/0.63A SI-R - Electronic circuit breaker

1464485

<https://www.phoenixcontact.com/us/products/1464485>



Single-channel, electronic device protection for 12-24 V DC loads. Fixed nominal current value: 0.63 A. With remote signaling, remote reset, and active current limitation. Can be combined with CLIPLINE terminal blocks. For installation on DIN rails.

QUINT4-SYS-PS/1AC/24DC/2.5/SC - Power supply unit



2904614

<https://www.phoenixcontact.com/us/products/2904614>

PTCB E1 24DC/0.63A NO - Electronic circuit breaker

1464486

<https://www.phoenixcontact.com/us/products/1464486>

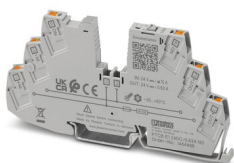

Single-channel, electronic device protection for 12-24 V DC loads. Fixed nominal current value: 0.63 A. With remote signaling and active current limitation. Can be combined with CLIPLINE terminal blocks. For installation on DIN rails.

PTCB E1 24DC/0.1-0.63A NO - Electronic circuit breaker

1441495

<https://www.phoenixcontact.com/us/products/1441495>



Single-channel, electronic device protection for 12-24 V DC loads. Nominal current adjustable from 0.1-0.63 A. With remote signaling and active current limitation. Can be combined with CLIPLINE terminal blocks. For installation on DIN rails.

QUINT4-SYS-PS/1AC/24DC/2.5/SC - Power supply unit



2904614

<https://www.phoenixcontact.com/us/products/2904614>

PTCB E1 24DC/0.1-0.63A SI-R - Electronic circuit breaker

1441496

<https://www.phoenixcontact.com/us/products/1441496>

Single-channel, electronic device protection for 12-24 V DC loads. Nominal current adjustable from 0.1-0.63 A. With remote signaling, remote reset, and active current limitation. Can be combined with CLIPLINE terminal blocks. For installation on DIN rails.

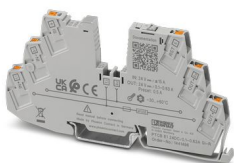

Phoenix Contact 2023 © - all rights reserved

<https://www.phoenixcontact.com>

Phoenix Contact USA
586 Fulling Mill Road
Middletown, PA 17057, United States
(+717) 944-1300
info@phoenixcon.com