

A-INSP-PG7-65N-P-BK - Screw plug



1047561

<https://www.phoenixcontact.com/us/products/1047561>

Please be informed that the data shown in this PDF document is generated from our online catalog. Please find the complete data in the user documentation. Our general terms of use for downloads are valid.



Screw plug, material for screw connection: PA, connecting thread: Pg7, color: jet black RAL 9005, with O-ring

Commercial data

Item number	1047561
Packing unit	1 pc
Minimum order quantity	10 pc
Sales key	BF68
Product key	BF7DZX
Catalog page	Page 703 (C-2-2019)
GTIN	4055626648361
Weight per piece (including packing)	1.05 g
Weight per piece (excluding packing)	0.873 g
Customs tariff number	39269097
Country of origin	DE

A-INSP-PG7-65N-P-BK - Screw plug

1047561

<https://www.phoenixcontact.com/us/products/1047561>

Technical data

Product properties

Product type	Plug for cable screw gland
--------------	----------------------------

Dimensions

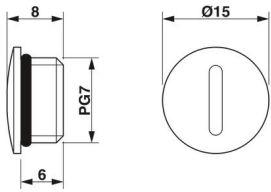
Dimensional drawing	
Length	8 mm
Length of the connecting thread	6 mm
Diameter	15 mm
	15 mm
Thread type connection side	Pg7

Material specifications

Seal material O-ring	NBR
Material for screw connection	PA

Environmental and real-life conditions

Ambient conditions

Degree of protection	IP65
Ambient temperature (operation)	-20 °C ... 100 °C

A-INSP-PG7-65N-P-BK - Screw plug

1047561

<https://www.phoenixcontact.com/us/products/1047561>



Drawings

Dimensional drawing

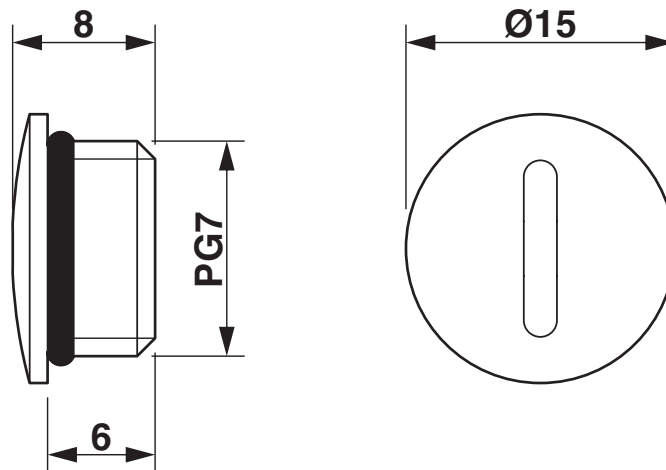

Dimensional drawing

A-INSP-PG7-65N-P-BK - Screw plug



1047561

<https://www.phoenixcontact.com/us/products/1047561>

Classifications

ECLASS

ECLASS-11.0	23111190
ECLASS-12.0	23111190
ECLASS-13.0	23111190

ETIM

ETIM 9.0	EC000032
----------	----------

UNSPSC

UNSPSC 21.0	31261500
-------------	----------

A-INSP-PG7-65N-P-BK - Screw plug



1047561

<https://www.phoenixcontact.com/us/products/1047561>

Environmental product compliance

China RoHS	Environmentally friendly use period: unlimited = EFUP-e
	No hazardous substances above threshold values

A-INSP-PG7-65N-P-BK - Screw plug

1047561

<https://www.phoenixcontact.com/us/products/1047561>



Accessories

A-INL-PG7-P-BK - Counter nut

1424558

<https://www.phoenixcontact.com/us/products/1424558>

Counter nut, connecting thread: Pg7, color: jet black



Phoenix Contact 2023 © - all rights reserved
<https://www.phoenixcontact.com>

Phoenix Contact USA
586 Fulling Mill Road
Middletown, PA 17057, United States
(+717) 944-1300
info@phoenixcon.com