

# HC-EVO-B24PT-BWD-HH-M32-PLRBK - Connector set



1407713

<https://www.phoenixcontact.com/us/products/1407713>

Please be informed that the data shown in this PDF document is generated from our online catalog. Please find the complete data in the user documentation. Our general terms of use for downloads are valid.



EVO connector set, consisting of sleeve housing, panel mounting base, push-in contact inserts:  
1407735, 1407736, 1407661, 1407657, 1407671

## Your advantages

- Lower costs than metal version
- Labeling option using 9 x 20 mm marking label
- Low weight
- Lower risk of condensation

## Commercial data

Item number	1407713
Packing unit	1 pc
Minimum order quantity	1 pc
Sales key	BF63
Product key	AF7AFX
Catalog page	Page 646 (C-2-2019)
GTIN	4046356777780
Weight per piece (including packing)	570 g
Weight per piece (excluding packing)	570 g
Customs tariff number	85366990
Country of origin	CN

# HC-EVO-B24PT-BWD-HH-M32-PLRBK - Connector set



1407713

<https://www.phoenixcontact.com/us/products/1407713>

## Set consists of

### HC-B24-I-PT-F - Contact insert

1407735

<https://www.phoenixcontact.com/us/products/1407735>



Contact insert, number of positions: 24+PE, size: B24, number of connections per position: 1, Socket, Push-in connection, 500 V, 16 A, 0.14 mm<sup>2</sup> ... 2.5 mm<sup>2</sup>, application: Power

---

### HC-B24-I-PT-M - Contact insert

1407736

<https://www.phoenixcontact.com/us/products/1407736>

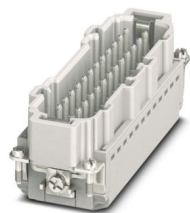

Contact insert, number of positions: 24+PE, size: B24, number of connections per position: 1, Pin, Push-in connection, 500 V, 16 A, 0.14 mm<sup>2</sup> ... 2.5 mm<sup>2</sup>, application: Power

# HC-EVO-B24PT-BWD-HH-M32-PLRBK - Connector set



1407713

<https://www.phoenixcontact.com/us/products/1407713>

## HC-EVO-B24-BWD-PLRBK - Housing

1407661

<https://www.phoenixcontact.com/us/products/1407661>



HEAVYCON EVO panel mounting base, plastic, B24, with double locking latch, height: 30.5 mm, with flat gasket

---

## HC-EVO-B24-HHFD-PLBK - Housing

1407657

<https://www.phoenixcontact.com/us/products/1407657>



HEAVYCON EVO sleeve housing, plastic, with bayonet flange for EVO screw connection, B24, for double locking latch, height: 87.5 mm, without EVO screw connection

# HC-EVO-B24PT-BWD-HH-M32-PLRBK - Connector set



1407713

<https://www.phoenixcontact.com/us/products/1407713>

## HC-B-G-M32-PLRBK - Cable gland

1407671

<https://www.phoenixcontact.com/us/products/1407671>



EVO plastic cable gland with bayonet locking, for housing series B, size M32, cable diameter: 11 mm ... 21 mm

# HC-EVO-B24PT-BWD-HH-M32-PLRBK - Connector set



1407713

<https://www.phoenixcontact.com/us/products/1407713>

## Technical data

### Product properties

Product type	Connector set
Housing type	Complete housing
Series	HC-B
Type	B24
Number of positions	24
Connection profile	24+PE
Contact numbering	1 - 24
No. of cable outlets	1
Type of the screw connection	1x M32
Protective cover	no
Cable outlet	straight
Pg screw connection	none

### Insulation characteristics

Overvoltage category	III
Degree of pollution	3

### Electrical properties

Rated voltage (III/3)	500 V
Rated surge voltage	6 kV
Rated current	16 A

### Connection data

Connection method	Push-in connection
Connection technology	Push-in connection
Conductor cross section	0.14 mm <sup>2</sup> ... 2.5 mm <sup>2</sup> (with ferrule) 0.14 mm <sup>2</sup> ... 2.5 mm <sup>2</sup> (with ferrule)
Connection cross section AWG	26 ... 14 (with ferrule)
Tightening torque	0.5 Nm ... 1.7 Nm (Fixing screws for panel mounting base)
Stripping length	8 mm ... 10 mm

### Dimensions

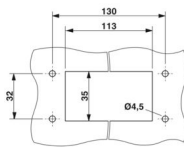
Dimensional drawing	
Width	53 mm
Height	130 mm
Length	140.5 mm
Drill hole distance, horizontal	129.5 mm

# HC-EVO-B24PT-BWD-HH-M32-PLRBK - Connector set



1407713

<https://www.phoenixcontact.com/us/products/1407713>

Drill hole distance, vertical	32 mm
-------------------------------	-------

## Installation dimensions

Width of the assembly cutout	35 mm
Length of the assembly cutout	113 mm

## Material specifications

Flammability rating according to UL 94	V0
Seal material Profile gasket	NBR
Seal material Flat gasket	NBR
Housing material	PA
Contact material	Copper alloy
Contact surface material	Ag
Contact carrier material	PA
Locking latch material	PA

## Cable/line

External cable diameter	11 mm ... 21 mm
-------------------------	-----------------

## Mechanical properties

### Mechanical data

Type of the screw connection	1x M32
Locking type	Latch
Insertion/withdrawal cycles	≥ 500

## Environmental and real-life conditions

### Ambient conditions

Degree of protection	IP66
Enclosure rating (NEMA)	12 (UL 50e)
Impact strength	IK09
Ambient temperature (operation)	-40 °C ... 100 °C

## Mounting

Assembly note	Coding also using the CP-HC (1686478) coding profiles. HC-B6.. / HC-B10..for two coding profiles. HC-B16.. / HC-B24..for four coding profiles.
	Connectors may only be operated when there is no load/the power is switched off. Can be used for solid wires and stranded wires with ferrule.

# HC-EVO-B24PT-BWD-HH-M32-PLRBK - Connector set



1407713

<https://www.phoenixcontact.com/us/products/1407713>

## Drawings

Dimensional drawing

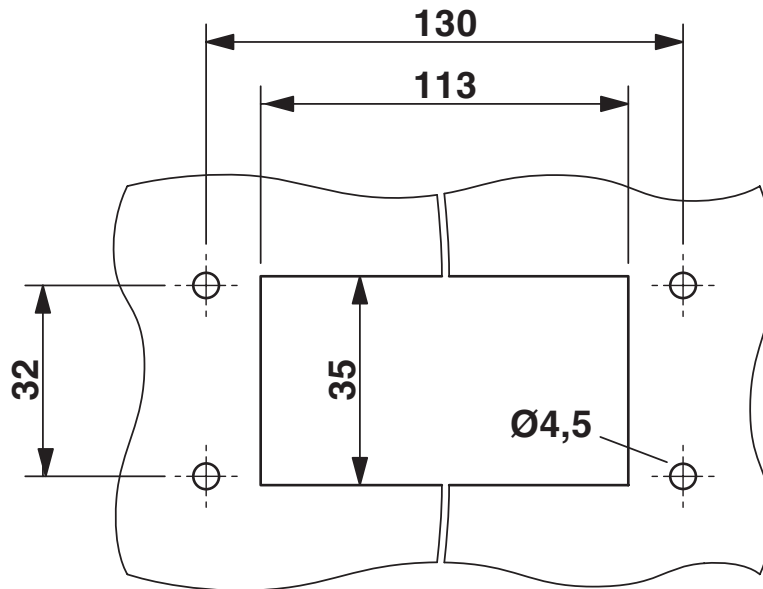

Mounting cutout

Dimensional drawing

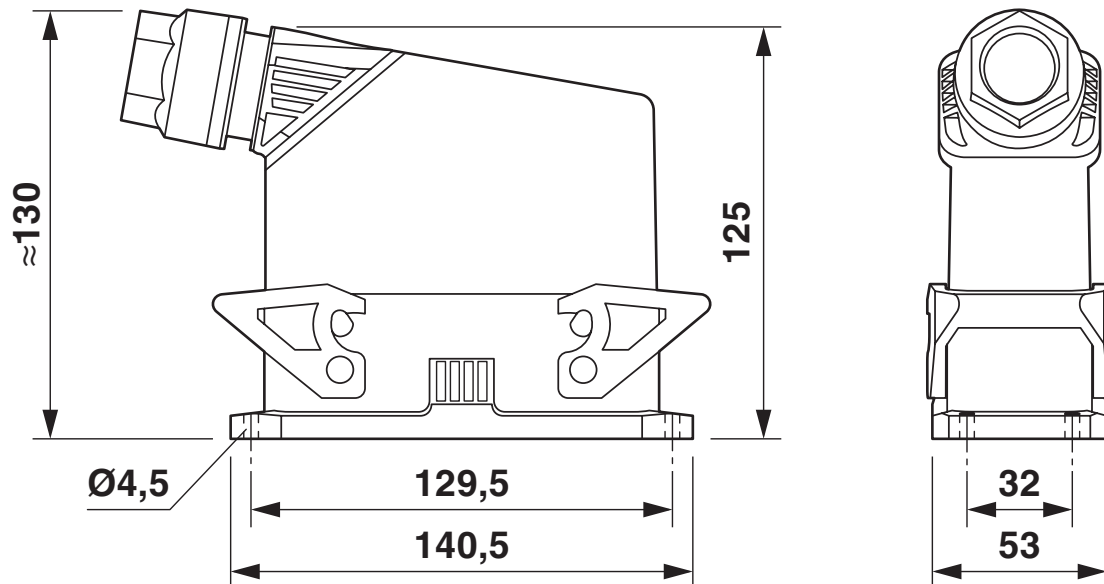

Dimensional drawing

# HC-EVO-B24PT-BWD-HH-M32-PLRBK - Connector set



1407713

<https://www.phoenixcontact.com/us/products/1407713>

Schematic diagram

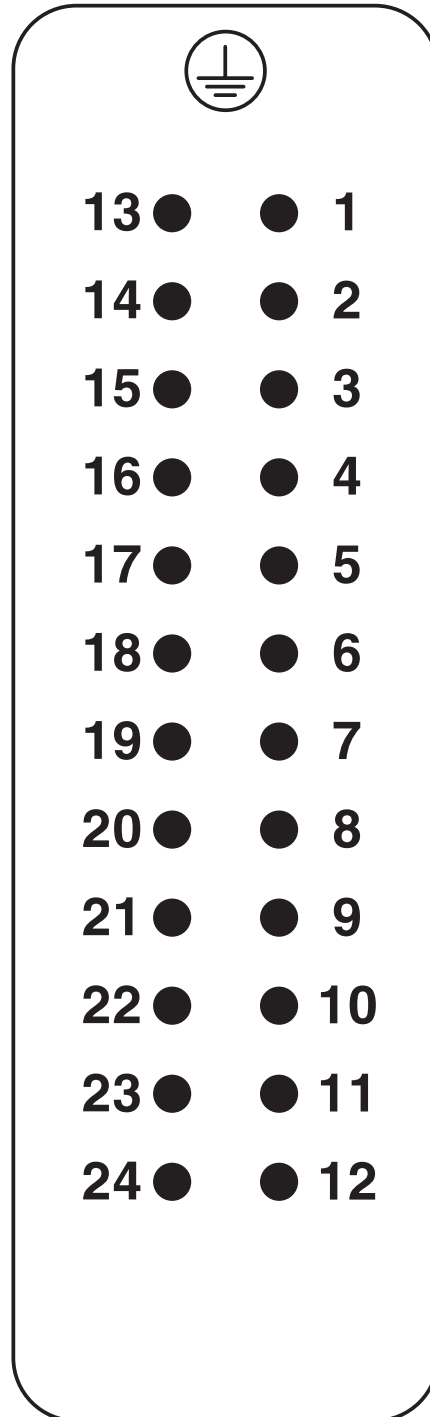

Pin assignment, connection side, pin



# HC-EVO-B24PT-BWD-HH-M32-PLRBK - Connector set



1407713

<https://www.phoenixcontact.com/us/products/1407713>

Schematic diagram

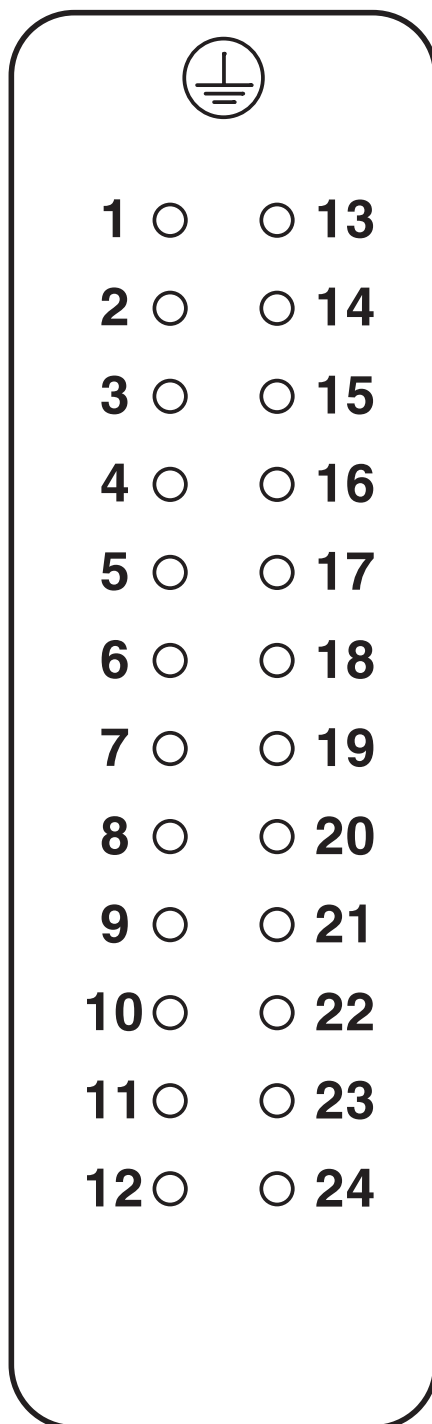

Pin assignment, connection side, socket

# HC-EVO-B24PT-BWD-HH-M32-PLRBK - Connector set



1407713

<https://www.phoenixcontact.com/us/products/1407713>

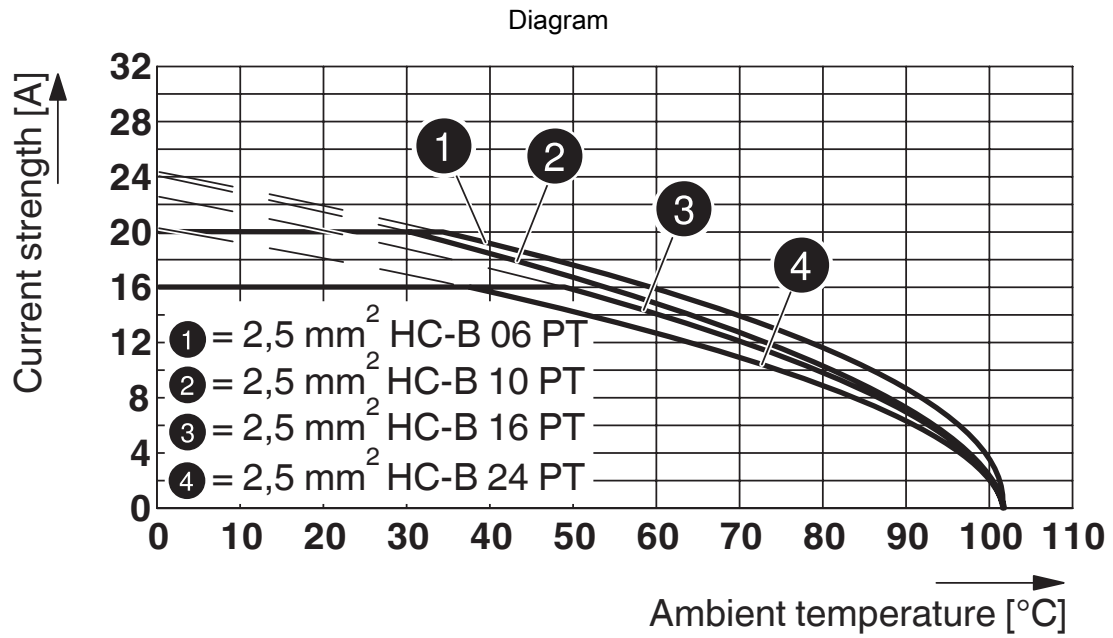

Derating diagram

# HC-EVO-B24PT-BWD-HH-M32-PLRBK - Connector set



1407713

<https://www.phoenixcontact.com/us/products/1407713>

## Approvals

To download certificates, visit the product detail page: <https://www.phoenixcontact.com/us/products/1407713>

**DNV**

Approval ID: TAE000037S

# HC-EVO-B24PT-BWD-HH-M32-PLRBK - Connector set



1407713

<https://www.phoenixcontact.com/us/products/1407713>

## Classifications

### ECLASS

ECLASS-11.0	27440101
ECLASS-12.0	27440113
ECLASS-13.0	27440113

### ETIM

ETIM 9.0	EC002636
----------	----------

### UNSPSC

UNSPSC 21.0	39121400
-------------	----------

# HC-EVO-B24PT-BWD-HH-M32-PLRBK - Connector set



1407713

<https://www.phoenixcontact.com/us/products/1407713>

## Environmental product compliance

### EU RoHS

Fulfills EU RoHS substance requirements	Yes, No exemptions
---	--------------------

### China RoHS

Environment friendly use period (EFUP)	EFUP-E
	No hazardous substances above the limits

### EU REACH SVHC

REACH candidate substance (CAS No.)	No substance above 0.1 wt%
-------------------------------------	----------------------------

Phoenix Contact 2025 © - all rights reserved  
<https://www.phoenixcontact.com>

Phoenix Contact USA  
586 Fulling Mill Road  
Middletown, PA 17057, United States  
(+717) 944-1300  
[info@phoenixcon.com](mailto:info@phoenixcon.com)