

RAD-CONF-RF7 - Configuration memory



2902816

<https://www.phoenixcontact.com/us/products/2902816>

Please be informed that the data shown in this PDF document is generated from our online catalog. Please find the complete data in the user documentation. Our general terms of use for downloads are valid.



Radioline - configuration stick for easy and safe network addressing for the 2.4 GHz wireless module (RAD-2400-...), unique network ID, RF band 7

Your advantages

- Easy, unique, and safe network addressing
- Parallel operation of multiple networks (using different RF bands)

Commercial data

Item number	2902816
Packing unit	1 pc
Minimum order quantity	1 pc
Sales key	DN23
Product key	DNC61Z
Catalog page	Page 376 (C-6-2019)
GTIN	4046356682114
Weight per piece (including packing)	5.5 g
Weight per piece (excluding packing)	5.5 g
Customs tariff number	85235110
Country of origin	DE

RAD-CONF-RF7 - Configuration memory



2902816

<https://www.phoenixcontact.com/us/products/2902816>

Technical data

Product properties

Product type	Storage medium
--------------	----------------

RAD-CONF-RF7 - Configuration memory

2902816

<https://www.phoenixcontact.com/us/products/2902816>

Drawings

Schematic diagram

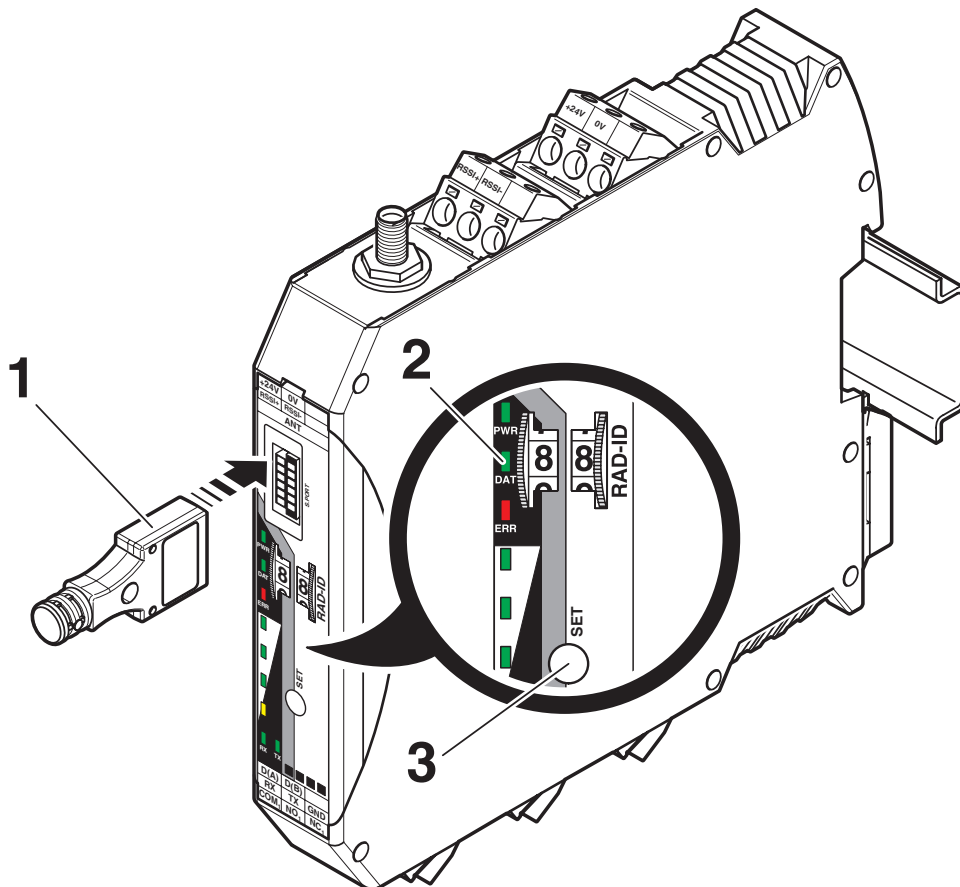

Configuration via CONFSTICK

RAD-CONF-RF7 - Configuration memory



2902816

<https://www.phoenixcontact.com/us/products/2902816>

Classifications

ECLASS

ECLASS-11.0	27242212
ECLASS-13.0	27242212
ECLASS-12.0	27242212

ETIM

ETIM 9.0	EC000192
----------	----------

UNSPSC

UNSPSC 21.0	32101600
-------------	----------

RAD-CONF-RF7 - Configuration memory



2902816

<https://www.phoenixcontact.com/us/products/2902816>

Environmental product compliance

China RoHS	Environmentally Friendly Use Period = 50 years For information on hazardous substances, refer to the manufacturer's declaration available under "Downloads"
------------	--

Phoenix Contact 2023 © - all rights reserved
<https://www.phoenixcontact.com>

Phoenix Contact USA
586 Fulling Mill Road
Middletown, PA 17057, United States
(+717) 944-1300
info@phoenixcon.com